

PAPER • OPEN ACCESS

Experimental and Numerical dynamic characterization of a human tibia

To cite this article: Lorenzo Verdenelli *et al* 2018 *J. Phys.: Conf. Ser.* **1149** 012029

View the [article online](#) for updates and enhancements.

Recent citations

- [Feasibility study of performing experimental modal analysis with oblique impact testing using various oblique impact directions](#)
Shin Yee Khoo *et al*



240th ECS Meeting ORLANDO, FL

Orange County Convention Center **Oct 10-14, 2021**



Abstract submission due: April 9

SUBMIT NOW

Experimental and Numerical dynamic characterization of a human tibia

Lorenzo Verdenelli, Robert Rossetti, Paolo Chiariotti, Milena Martarelli and Lorenzo Scalise

Università Politecnica delle Marche, via Brecce Bianche, 60131, Ancona, Italy

E-mail: l.scalise@univpm.it, p.chiariotti@univpm.it

Abstract. Many studies from the early 70s have determined the possibility, through the use of vibrations, to analyze the response of a human tibia in order to study its dynamic behavior under different excitation conditions and for different purposes. Comparative studies between contact and non-contact techniques have been carried out over the years, but in the case of non-uniform structures in form and materials, such as a human tibia, there is a lack of information. The aim of this paper is to dynamically characterize a human tibia replica, with the same mechanical and morphological properties, with and without an external fixation system highlighting limits and advantages of contact and non-contact approaches.

This work proposes a comparison, in terms of FRFs and modal parameters, between the tibia alone and in the presence of an external fixation system, moreover the experimental data are compared also with a numerical model of such structures. Tests have been carried out using a mono-axial accelerometer for the contact measurement approaches and a laser Doppler vibrometer (632nm wavelength) for the non-contact one. The tibia has been placed on a foam support in order to simulate free-free conditions. The input was supplied both by a shaker and by a micro-hammer, keeping the same excitation direction. Results show that shaker-based excitation and micro-hammer excitation method can cause issues on the response measured with lasers. Modal analysis results tend to smooth these issues, even though laser-based data tend to sense a vertical in-plane in correspondence of the third horizontal mode because multiple components are sensed simultaneously during the scan.

1. Introduction

The fractures of the lower limbs, femur and / or tibia, are fractures which are among the most common in the event of road accidents, osteoporosis, sport or among injuries reported in war. In particular, tibial fractures are very important since, more than femur, they are more subject to support a greater amount of body weight. Weight is supported not only statically, when the person is at rest, but also and above all dynamically, when the person is walking or doing physical activity. For these reasons tibia fractures can be very impactful on every day life, especially those diaphyseal fractures that are displaced and/or exposed and for which the need of an external fixation system is required in order to provide a correct stabilization and healing process.

This research activity is part of a bigger work which final aim is to validate a non-invasive and non-ionizing method able to detect through the vibrations transmitted via the pins of the external fixation system, the status of the healing process in a tibia fracture, starting from past studies, where the excitation was given directly on the patient leg and the response measured



manually pressing the accelerometer on the leg [1], [2], [3], [4], until reach the more recent ones where the attention has been shifted from the patient's leg to the external fixation system. As Mattei et al.[5] and other [6] in literature have been demonstrated, using the external fixation system as a propagating medium to transmit the vibrations results in a more clean and usable output signal, since there will be less artifacts due to muscles and soft tissues and so less damping effect too and in the end using the fixation system it is possible to be least invasive on the patient. But before being able to proceed with the transmissibility tests through the fixation system, it is first necessary to understand how the tibia, a structure with a complex geometry and composite in the materials, behaves when subject to vibrations.

The aim of this research was to dynamically characterize the tibia with and without the external fixation. This means initially carrying out a characterization of the structure, experimentally and numerically. Characterization that will allow us not only to optimize the measurement system, choosing between different input/output techniques, but also to understand how the tibia, with and without the external fixation system, behaves when subject to vibrations and numerically validate the 3D models that could be then used to simulate different fracture typologies and/or different fixation configurations.

2. Materials and Methods

Different excitation and response sensing strategy used for the experimental tests are presented and compared in terms of their efficacy. The numerical simulations set-up will be also presented and carefully explained.

2.1. Experimental characterization of the tibia model

The tibia used for the experimental test was a 4th generation Sawbones large left tibia (#3402) with a mass of about 350 ± 1 g, 405 ± 1 mm in length (longitudinal axis; proximal to distal axis; x-axis) with an inner canal of 10 mm in diameter. The tibia is suitable for biomechanical tests since it has been proved to have a comparable mechanical behavior to cadaveric tibias. The specimen is made of composite materials in order to reproduce as much as possible the real bone structure, i.e. short fiber filled epoxy (Young's modulus between 10-16 GPa) replicating the cortical bone, and rigid polyurethane foam (Young's modulus between 137-155 MPa) replicating the cancellous bone.

The complex geometry of the tibia and its lightweight-nature make the experimental study task quite tough. For this reason, different combinations, in terms of input/output methods have been investigated, as reported in Tab. 1.

Table 1. Input/Output devices.

INPUT	OUTPUT
Instrumented Micro-Hammer Shaker	Laser Doppler Vibrometer Single-Axis Accelerometer

2.1.1. Input excitation

Impact excitation The micro-hammer used to excite the tibia is a Modally Tuned ICP Impulse Hammer by PCB Piezotronics (Model No: 086D80) with a sensitivity varying according to the tip used and a resonant frequency ≥ 100 kHz . For this specific test the tip used was a vinyl tip

giving an hammer sensitivity of 15.92 (mV/N). A vinyl tip was used because the steel one would have not given a correct output due to the specific of the structure under test. The impulse was given at the lateral condyle in an oblique way in order to excite both the horizontal and vertical modes. The hammer works in conjunction with a PCB ICP Power Unit (Model No:484B) that features an AC signal decoupling mode for standard operation with ICPsystems as well as a DC mode for calibration or ultra low frequency operation.

Random excitation The shaker used to excite the tibia is a Tira GmbH (type: TV 50009) vibration exciters. These shakers are characterized by high lateral and axial stiffness. The shaker is powered by a power amplifier BAA 60 and has been connected to the tibia through a stinger, of 7 cm in length, and a PCB dynamic force sensor (208 A03). The force sensor was used to record the force generated by the shaker.

The shaker too has been mounted in correspondence of the lateral condyle with a specific angle in order to excite both the horizontal and vertical modes of the tibia.

2.1.2. Output response

Laser Doppler Vibrometer (LDV) The Laser Doppler Vibrometer used for the measurements is a Polytec LDV HeNe (wavelength 632nm). The LDV works in conjunction with a vibrometer controller that permits the operator to easily select measurement ranges, filters and controlling remote focus. Furthermore a signal strength indication is shown on the LCD panel in order to optimize the focusing of the optics head. The Polytec LDV sensor OFV-055 and the vibrometer controller OFV-3001 S that we used in the experiment can be configured to detect vibrations under different velocity ranges: 1, 5,10, 25, 125 and 1000 mm/s. To analyze the tibia the velocity range has been set on 10 mm/s.

Single axis accelerometer The accelerometer used for the experiment is a mono-axial PCB ICP Accelerometer (model No: 352C23), powered by simple, inexpensive, constant current conditioners and characterized by fixed voltage sensitivity, low-impedance output signal, low noise and intrinsic self-test feature. The sensitivity of the accelerometer is 5.11 mV/g with a resonant frequency 70 kHz and an optimal frequency range (+/- 5%) ranging from 2.0 to 10,000 Hz. In order to use the accelerometer on the tibia, a very little quantity of wax has been used so as not to dampen the signal excessively.

2.1.3. Boundary conditions The specimen has been placed on an acoustic foam bed. Then two pieces of an other acoustic foam have been placed near the lower and upper epiphyses in order to reproduce as much as possible the free-free conditions. In this way only the extremities of the specimen lean on the supports.

2.1.4. Signal Analysis The tests have been performed using the LMS Test.Lab by Siemens [7], which is a solution for experimental vibrational analysis that includes tools for data acquisition (LMS SCADAS), test execution and data processing. The LMS SCADAS have been used to acquire the signals from the load cell, the accelerometer and the LDV and to control the amplifier connected to the shaker and to the micro-hammer, through a digital-analog converter output. The Impact Testing and the Spectral Testing modules enables all test parameters to be set for impact(hammer) and shaker (random) tests. The modal Analysis module offers a solution with full functionality for experimental modal analysis. The solution allow to identify the dynamic properties of a structure with tools to easily create frequency response function (FRF) sets,

carry out modal parameter evaluations, validate the experimental modal analysis modes and compare the original FRF data with summarized results.

2.1.5. External fixation system The external fixation used for the experimental tests is an Hoffmann II Tibia Shaft Frame. The fixation system total mass is about 677.04 ± 1 g. The configuration used is the standard configuration for treat the tibia shaft fracture. The fixation is composed of different components. The only ones that interact with the bone are the pins that are screwed into the bone through the cortical and cancellous bone coming out the opposite side of about 3 mm. The materials of the single components are carbon fibers for the connecting rods, austenitic steel for the pins, alluminum for the clamps, posts and delta couplings.

2.2. Numerical model of the tibia

To get the same size and a more than good fidelity in details the first step was to make a scanning of the model. The 3D scanning of the tibia model has been made using a Non-Contact 3D Digitizer - RANGE 7 by KONICA MINOLTA [8]. The scanning system present a semiconductor laser ($\lambda=660\text{nm}$), CMOS sensor of 1,31 Mega Pixel(1280x1024) , with an accuracy of $\pm 40\mu\text{m}$ (standard measures with globular objects) and a precision of $\pm 4\mu\text{m}$ (standard measures with a KONICA MINOLTA reference plain chart).

The mesh of a scanned model is typically rough and not clean and for this reasons it's not suitable for being directly used in a numerical simulation suite. The refinement process on the tibia geometry has been done using a specific software for mesh optimization called Meshmixer. Once the 3D model of the tibia has been obtained and its mesh optimized for the simulation, it has been imported into COMSOL Multiphysics [9]. For our purpose the simulation was done using the Structural Mechanics Module. A frequency domain study was performed to obtain the mode shapes [10] of the tibia. In the Structural Mechanics Module it was set a point load with an harmonic perturbation, simulating the input given by the hammer and shaker in the same direction and position of the experimental tests.

3. Tibia dynamic characterization results

The following results show a comparison in terms of FRFs and modal parameters [11] obtained using the different measurement set-up presented previously. The experimental tests with the instrumented micro-hammer and with the shaker have been done considering a frequency range between 0-2000 Hz. Particularly important is the range between 200-2000 Hz because it represents our range of interest, within which are located the bending modes of the tibia.

3.1. Impact excitation

The impact test has been done with the following set-up:

- **EXCITATION INPUT:** Instrumented Micro-Hammer;
- and using these response output techniques:
- **RESPONSE OUTPUT 1:** Laser Doppler Vibrometer (LDV)
 - **RESPONSE OUTPUT 2:** Accelerometer

As it is possible to see from the image in Fig 1 a comparison, given in terms of FRFs amplitude and phase data, between the structure FRFs obtained measuring with the LDV and accelerometer of a single point, out of a total of 102, that corresponds to the Tibial Tuberosity is shown. The accelerometer signal has been integrated in order to obtain the velocity and so being able in this way to compare it with the LDV signal. Focusing on the range of interest (200-2000 Hz), Fig 2, is possible to see how even if at lower frequencies the two signals seem to be well correlated, moving towards the higher ones the signal, specially that of the LDV, shows

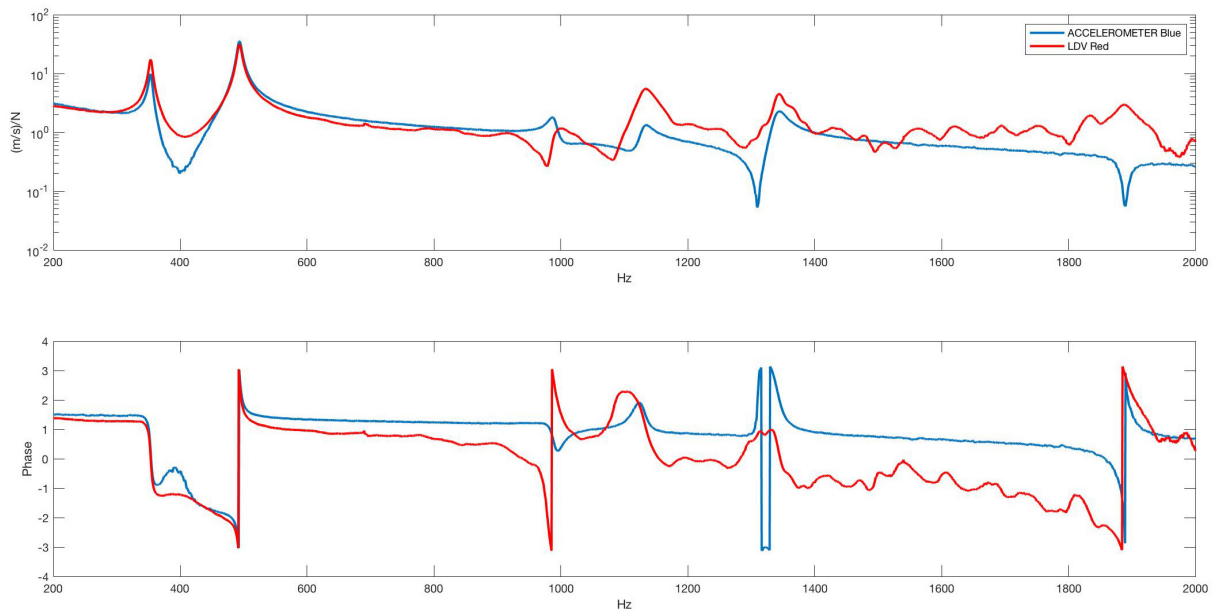

Figure 1. Micro-hammer excitation frequency response functions for accelerometer and LDV (amplitude and phase charts)

a noisy behavior. Also the signal provided by the accelerometer shows a bad behavior with a decrease in amplitude at higher frequencies. Highlighted in fig.2 by circles, it is possible to

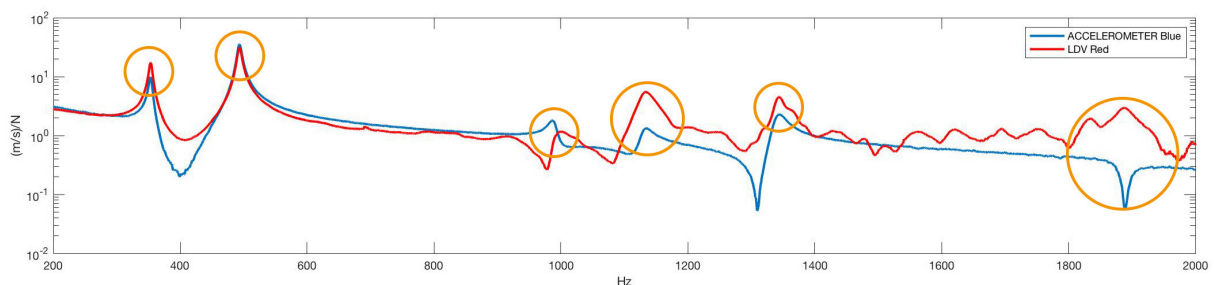
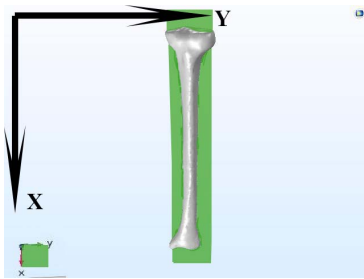
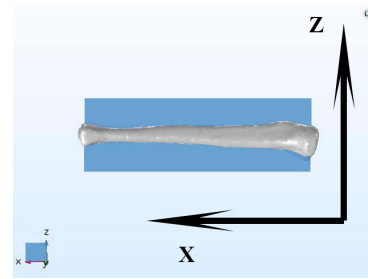

Figure 2. Frequency response functions and resonant peaks with micro-hammer excitation for accelerometer and LDV (amplitude)

see the resonant peaks related to the vibrating modes of the tibia. For frequencies higher than 1kHz, the peaks are no more clearly identifiable, especially those around the 1800 Hz, where the third horizontal mode of the tibia is present. The reason for which the laser is not able to provide a sufficient good signal at higher frequencies can be because the micro-hammer is not able to provide a good amount of energy on such a complex geometry and also because the impact of the micro-hammer causes the tibia to move excessively to ensure correct reading by the laser, generating the ring effect at higher frequencies. However, also the impossibility to guaranteed a constant repeatability for each point under investigation is the cause of this bad output signal. This lack of energy and repeatability is also present in the accelerometer signal that shows a decrease in amplitude both at lower and higher frequencies. In Tab. 2 it is possible to observe the resonant frequencies related to the vibrating modes of the tibia excited with the micro-hammer.

Table 2. LDV and Accelerometer resonant peaks

Modes	LDV		Accelerometer	
	XY	XZ	XY	XZ
Mode 1	353.1 Hz	493 Hz	353.1 Hz	493 Hz
Mode 2	996.9 Hz	1344 Hz	986.7 Hz	1344 Hz
Mode 3	∅	∅	1877 Hz	∅

**Figure 3.** Tibia projection plane XY**Figure 4.** Tibia projection plane XZ

3.2. Random excitation

For the random test, the following set-up has been used:

- **EXCITATION INPUT:** Shaker excitation;

while for the output response:

- **RESPONSE OUTPUT 1:** Laser Doppler Vibrometer (LDV)
- **RESPONSE OUTPUT 2:** Accelerometer

In Fig 5 the comparison, in terms of FRFs and Phase, of the signals obtained exciting the tibia with a shaker driven with random noise. The shaker was attached to the structure in the same point where the impact excitation was given. As it is immediately observable the two signals appear to be much more better respect to those provided with the micro-hammer excitation, specially at higher frequencies. Restricting the frequency range to that of interest (Fig 6) The signal provided by the accelerometer too, appear to be much cleaner than that measured during the impact test. In particular if we move towards the higher frequencies, around 1827 Hz, we can see how, while before with the micro-hammer the accelerometer was not able to provide a clear signal and highlight the third mode on the horizontal plane, now, instead, through the shaker excitation it can highlight it. These better output signals were due to the fact that even if the shaker has a greater mass respect to the micro-hammer and that the shaker is linked to the tibia through a stinger, it is able to guarantee a constant repeatability in the excitation signal, for each point under investigation, and a greater amount of energy.

Using the random excitation, the FRFs of the two signals are highly correlated; in fact there are no shifts in frequency as observable in Tab. 3.

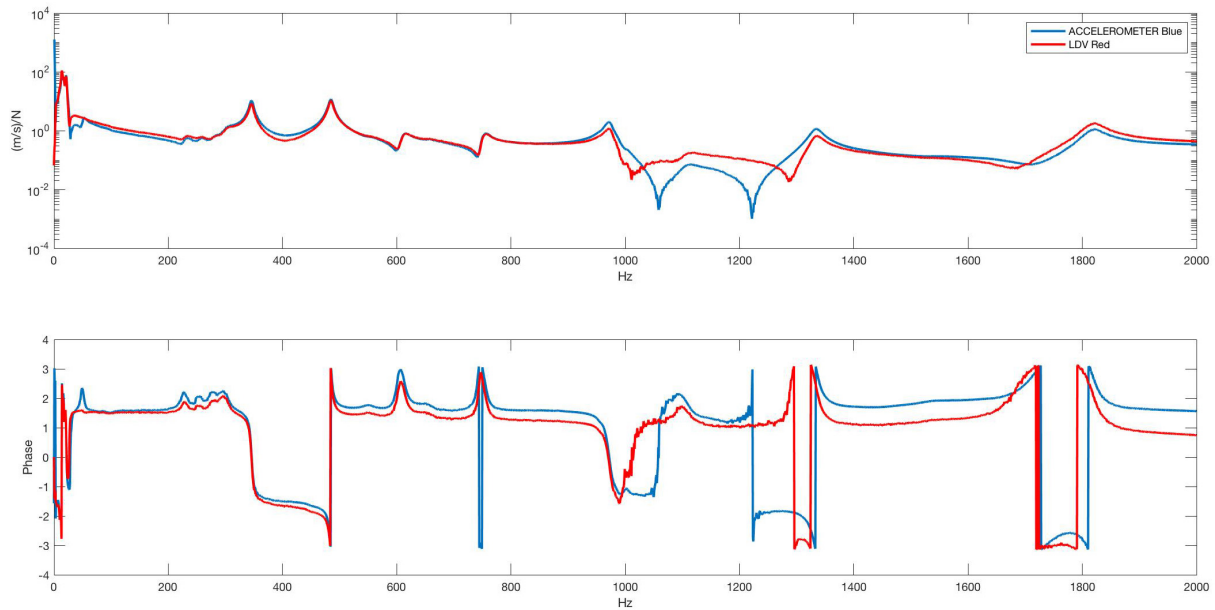

Figure 5. Shaker excitation frequency response functions for accelerometer and LDV (amplitude and phase charts)

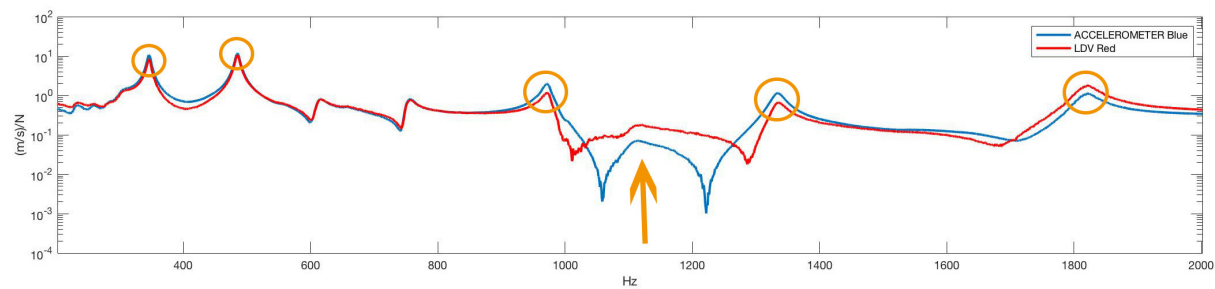

Figure 6. Frequency response functions and resonant peaks with random excitation

Table 3. LDV and Accelerometer resonant peaks

Modes	LDV		Accelerometer	
	XY	XZ	XY	XZ
Mode 1	345.3 Hz	485.2 Hz	345.3 Hz	485.2 Hz
Mode 2	971.9 Hz	1335 Hz	971.9 Hz	1334 Hz
Mode 3	1822 Hz	∅	1822 Hz	∅

The only mode that is not highlighted, because the point considered for the measurement does not make it possible to highlight it, is the torsional one that should be around the 1116 Hz (Orange arrow). The results obtained using the shaker and the accelerometer gave us the possibility to confirm also the goodness of our experimental test, and in particular the accuracy of our measurement set-up, comparing our data with those proposed by Mattei et al.(Tab. 4). They focused only on the frequency range 0-1kHz, so only the firsts modes were observable.

Table 4. Resonant Frequencies Comparison with Mattei et al.

Modes	Mattei et al.		Our results	
	XY	XZ	XY	XZ
Mode 1	353 Hz	496 Hz	345.3 Hz	485.2 Hz
Mode 2	965 Hz	∅	971.9 Hz	1334 Hz

An easy way to observe the goodness of the shaker excitation respect to that of the micro-hammer is to compare the coherence of the signals ((Fig 7)). Indeed, if we compare the coherence of the signal obtained with the micro-hammer and accelerometer and that obtained with the shaker and accelerometer is possible to see why the shaker is better than the micro-hammer. The blue signal (micro-hammer), shows some drop-off in the coherence signal at lower and higher frequencies that are the causes of the decrease in amplitude in the FRF and the inability to highlight correctly the resonant peaks at higher frequencies..

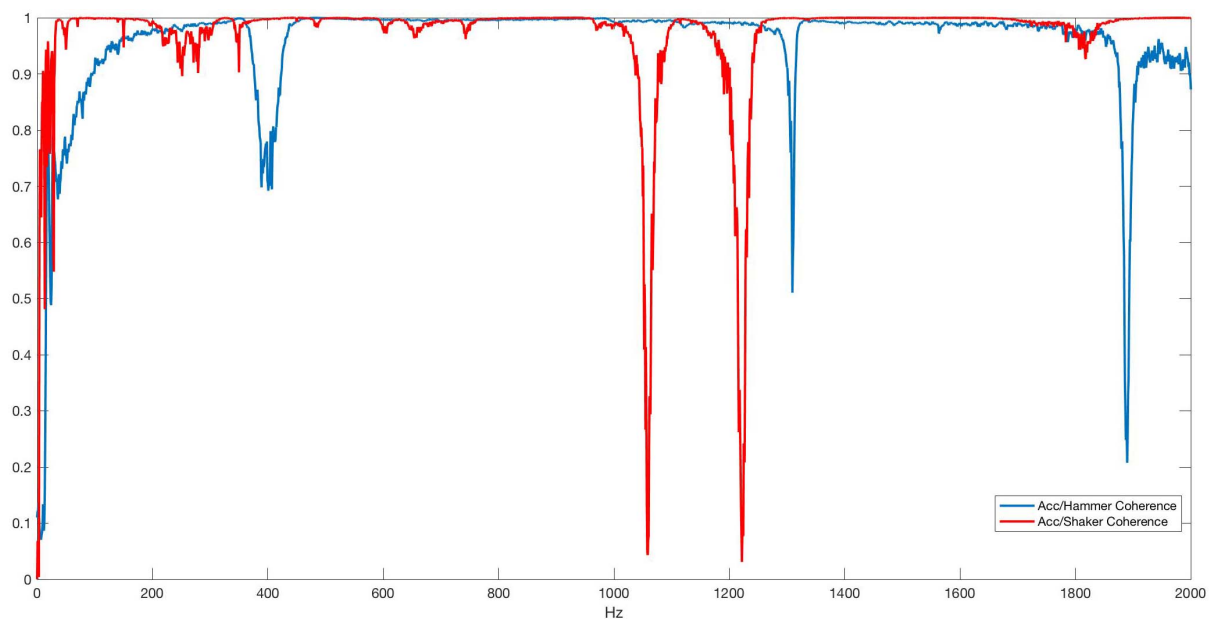
**Figure 7.** Coherence functions for micro-hammer and shaker excitations

3.3. Impact and random test Experimental modal analysis (EMA) comparison

Beacuse the LDV has been show a bad output signal exciting the tibia with the micro-hammer, the experimental modal analysis comparison has been done considering only the accelerometer (Fig 8) signal obtained with the micro-hammer and the two signals (Fig 14) obtained exciting with the shaker.

The main difference in the EMA of the signal excited by micro-hammer, can be found at higher frequencies, in particular for the second vertical mode and the third horizontal one that are not well stabilized as that given by the shaker. Instead, in Fig 10 the vibrating modes of the tibia obtained measuring with the LDV and exciting with the shaker are shown. Even if the LDV shows a perfect coherence in the stabilization of the modes with the accelerometer ones,

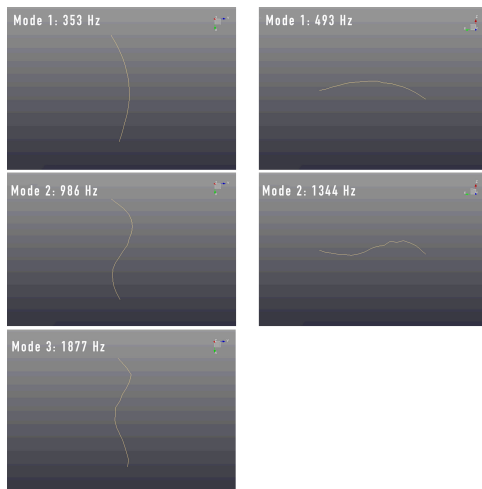

Figure 8. Micro-Hammer with Accelerometer Experimental Modal Analysis



Figure 9. Shaker with Accelerometer Experimental Modal Analysis

at 1822 Hz the LDV highlights not only the third horizontal mode but it senses also a vertical in-plane due to the excessive movement of the tibia excited which causes the third vertical mode to be shown. This is an error because the third vertical mode of the tibia is observable only above the 2200 Hz. The analysis of the structure mode shapes, together with the point FRFs



Figure 10. Shaker with LDV Experimental Modal Analysis

made it possible to identify in the shaker-accelerometer the best input-output combination to successfully characterize the tibia dynamics.

3.4. Tibia Experimental modal analysis (EMA) and Finite element analysis (FEA) comparison

The last step was to compare the EMA of the tibia with the mode shapes coming from the FEA done in COMSOL As shown in Fig 11 and in (Tab. 5) the horizontal modes of the FEA and those of the EMA match quite well. The main differences can be identified by observing the first and second vertical modes of the FEA where indeed there are some not indifferent variations in the frequencies when compared with those of the EMA. These frequency shifts for the vertical

modes are mainly due to the fact that in the numerical simulation the mass of the shaker is not included nor the constraint given by the stinger. Despite the frequency shift in the plane XZ

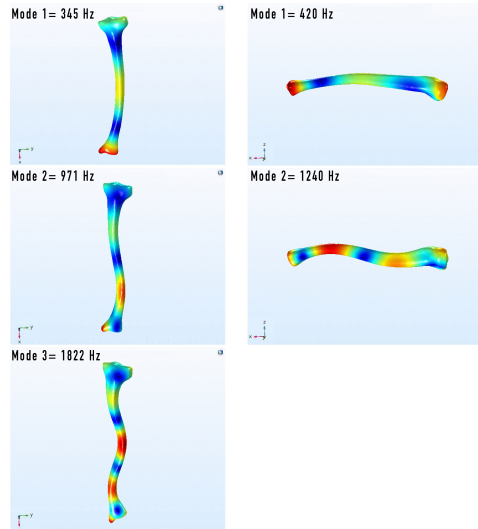

Figure 11. Numerical Mode Shapes

Table 5. Experimental modal analysis (EMA) and finite element analysis (FEA) modes

Modes	EMA		FEA	
	XY	XZ	XY	XZ
Mode 1	345.3 Hz	485.2 Hz	345.3 Hz	420 Hz
Mode 2	971.9 Hz	1335 Hz	971.9 Hz	1240 Hz
Mode 3	1822 Hz	∅	1822 Hz	∅

easily correctable, the numerical model can be considered valid.

4. Tibia with fixation system applied dynamic characterization results

The optimization of the measurement set-up allowed us to proceed with the analysis first on the fixation and then on the complete system tibia with external fixation mounted.

4.1. Tibia and tibia with external fixation system FRFs comparison

The measurements of the external fixation have been carried out experimentally using only the micro-hammer as excitation input and the mono-axial accelerometer as the response output. A total of 72 points were measured.

Once the measures on the fixation were made, it was mounted on the tibia and the experimental measurements were carried out. As expected the presence of the external fixation produces a significant effect on the tibia, going to modify the FRF in a really important way (Fig 12). The most important and relevant effects of the external fixation system on the tibia FRF are observable at lower frequencies, below the 200 Hz where many complex modes arise and at higher frequencies where the second and third horizontal modes were shifted downward of about

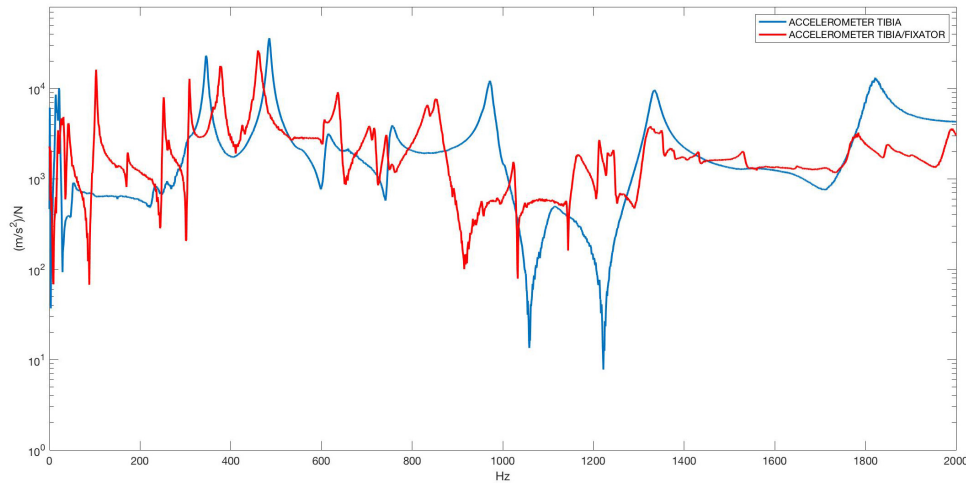

Figure 12. Frequency response functions for the tibia and the tibia with external fixation

100 Hz and 300 Hz respectively, and where the second vertical mode is completely blocked by the fixation, as can be seen in (Fig 13) and in (Tab. 6)

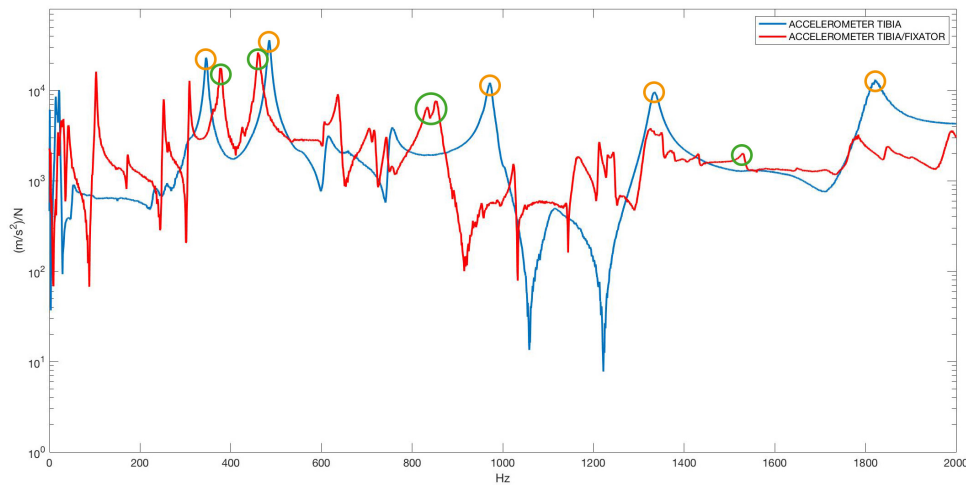

Figure 13. Comparison of the modes for the tibia and the tibia with an external fixation

Table 6. Tibia and tibia with external fixation Modes

Modes	Tibia		Tibia with external fixation	
	XY	XZ	XY	XZ
Mode 1	345.3 Hz	485.2 Hz	377 Hz	460 Hz
Mode 2	971.9 Hz	1335 Hz	844 Hz	∅
Mode 3	1822 Hz	∅	1530 Hz	∅

4.2. Tibia and Tibia with External Fixation EMA Comparison

Comparing those modes with those proposed by the modal analysis of the tibia, it is possible to see (Fig 14 and Fig 16) how the external fixation works on shifting downwards and blocking the modes of vibration. In particular this effect can be appreciate observing not much the first horizontal and vertical modes, that after all, they did not suffer so much from the presence of the fixation, but rather for the second and third horizontal modes which show a considerable decrease in the percentage of displacement. The effect of the external fixation, as said before,

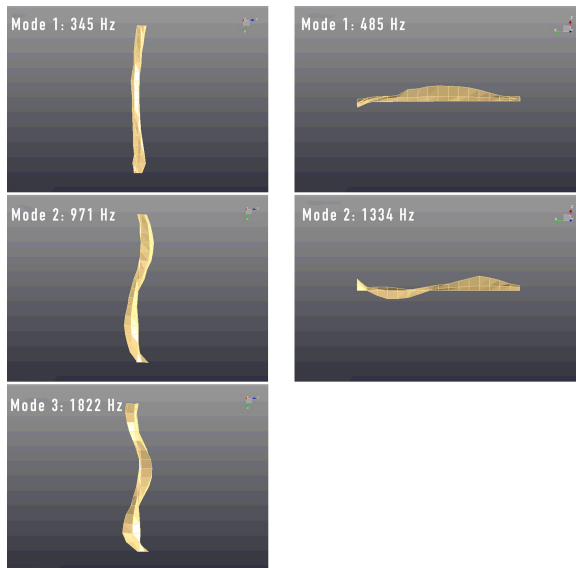

Figure 14. Tibia Experimental Modal Analysis (EMA)

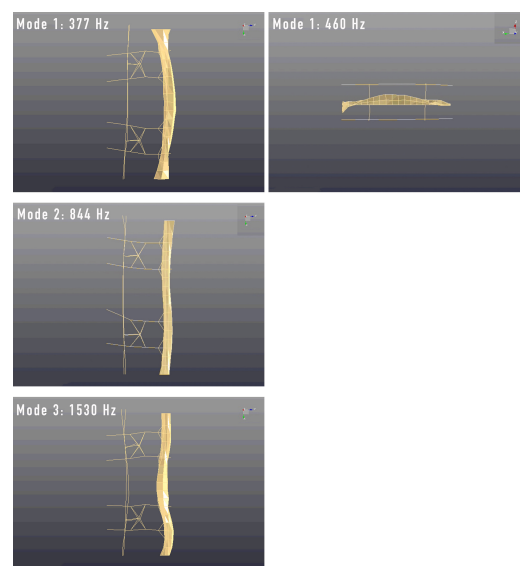

Figure 15. Tibia with External Fixation Experimental Modal Analysis

also acts considerably on the vertical modes, in particular on the second vertical mode that is not detected by the modal analysis since at higher frequencies the modes of vibrating of the fixation overhang, blocking, the movement of the tibia.

4.3. Tibia and Tibia with External Fixation EMA and FEA Comparison

With the 3D model of the external fixation validated it proceeded to the numerical simulation of the tibia with the fixation applied. As previously introduced, the fixation has been positioned in the same exact position of the real one and the numerical simulation has been done in free-free conditions due to the difficulty in recreating the perfect boundary constraints of the experimental one and without a point load applied, running in this way an eigenfrequencies study. But, even though the FEA has been done using this numerical set-up, the results obtained were very good. As shown in (Fig 17) the horizontal modes frequencies values are really close to that of the experimental data.

The shifts in frequency (Tab. 7) are easily referable to the specified numerical boundary conditions and to the fact that, as already said for the FEA of the tibia alone, in the numerical simulation the mass of the shaker was not considered.

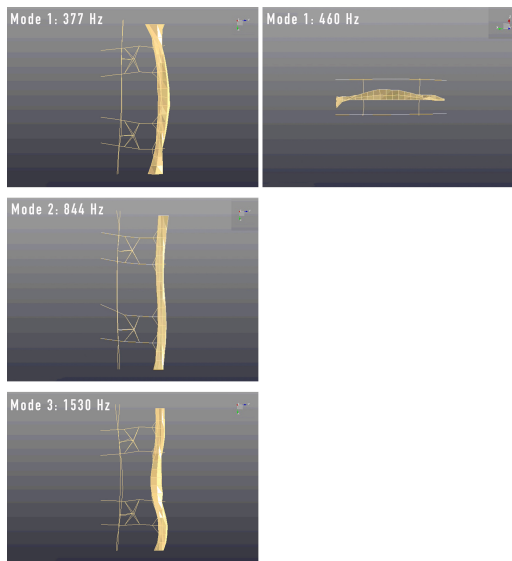

Figure 16. Tibia with external fixation Experimental Modal Analysis

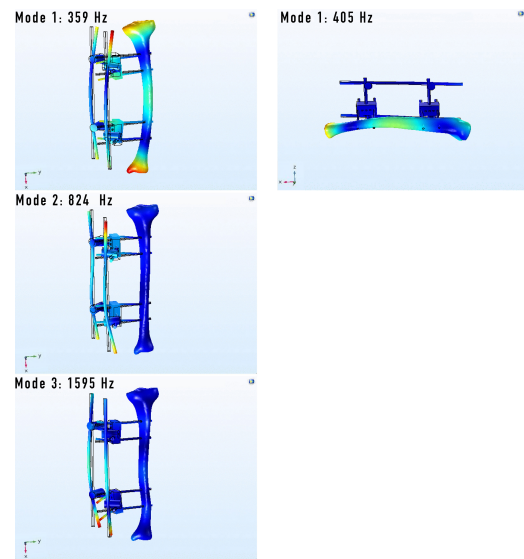

Figure 17. Tibia with External Fixation Mode Shapes

Table 7. Tibia and Tibia with Fixation Modes

Modes	Tibia		Tibia with external fixation	
Mode 1	359 Hz	405 Hz	377 Hz	460 Hz
Mode 2	824 Hz	∅	844 Hz	∅
Mode 3	1595 Hz	∅	1530 Hz	∅

5. Discussions and conclusions

The characterization on the tibia permit to highlight the advantages and disadvantages of all the input and output devices used. In particular, it highlighted that for this type of investigation, where a complex structure in geometry and materials has to be investigated, the best input/output measurement set-up is given by the shaker, due to the repeatability and the greater energy able to offer in the input signal compared to the micro-hammer and the accelerometer, since it turned out to be a more robust device, for the specific application, with respect to the Laser Doppler Vibrometer.

The results obtained exciting with the shaker and measuring with the accelerometer gave us the opportunity to validate also the goodness of our experimental test comparing it with the results of Mattei et al.[5]. In fact respect to them our results show a percentage decrease of about -2.18% for the first horizontal and of about -2.17% for the first vertical mode and a percentage increase of about 0.71% for the second horizontal one. These differences in percentage are related especially to the fact that respect to them our shaker was linked to the tibia through a stinger while they manually press the shaker on the specimen and because we excite on the lateral condyle while they excite at medial malleolus. The presence of the fixation has been identified instead to act very concretely on the vibrating modes of the tibia, observable both at the level of FRF, EMA and FEA, blocks the second vertical mode of the tibia and shifts the resonant frequencies of the second and third horizontal mode downwards; the second of about 100 Hz while the third of about 300 Hz.

Having validated the 3D tibia model, with and without the external fixation, was extremely important because, in particular the tibia model with fixation, allowed us to simulate the fracture and see how the tibia behaved, before proceeding experimentally, and what we will expect from the transmissibility test through the external fixation screws.

References

- [1] Folman et al 1993 *Arch Orthop Trauma Surg* **112** 193–197
- [2] Lippmann R K 1932 *J. Bone Jt Surg* **14** 118–126
- [3] McGaw N H 1942 *Arch. Surg* **45** 195–205
- [4] Seikiguchi T and Hirayama T 1979 *Acta orthopedics* **50** 391–398
- [5] Lorenza Mattei et al 2017 *Annals of Biomedical Engineering* **45** 1111–1121
- [6] Ong et al W H 2016 *Structural Control and Health Monitoring*
- [7] Lms modal analysis module URL <https://www.plm.automation.siemens.com/it/products/lms/testing/test-lab/structures/modal-analysis.shtml>
- [8] Konica minolta range 7 URL <https://www.konicaminolta.eu>
- [9] Comsol multiphysics URL <https://www.comsol.it>
- [10] Logan D L 2011 *A FIRST COURSE IN THE FINITE ELEMENT METHOD* (Cengage Learning)
- [11] Peter Avitabile *Experimental Modal Analysis, Sound and Vibration Magazine*