

Optical Engineering

OpticalEngineering.SPIEDigitalLibrary.org

Optical proximity sensor based on self-mixing interferometry

Dario Melchionni
Alessandro Pesatori
Michele Norgia

Optical proximity sensor based on self-mixing interferometry

Dario Melchionni, Alessandro Pesatori, and Michele Norgia*

Politecnico di Milano, Dipartimento di Elettronica, Informatica e Bioingegneria, Milano, Italy

Abstract. A proximity detector based on self-mixing technique, well suited for different industrial applications, is demonstrated. Instead of using a light-source plus a detector, the proposed sensor is realized by a single laser source. Two different physical effects in the laser diode allow for a continuous detecting range, from 10 mm up to 80 mm. The main advantages of the sensor are target detection from just one point of view; multiple sensors configuration does not need optical filters; separation of source and detector is eliminated; and background rejection is intrinsically given by the self-mixing effect, which shows a sharp cut-off after the focus. © 2018 Society of Photo-Optical Instrumentation Engineers (SPIE) [DOI: 10.1117/1.OE.57.5.051507]

Keywords: self-mixing interferometry; injection detection; proximity sensor.

Paper 171917SS received Nov. 30, 2017; accepted for publication Feb. 13, 2018; published online Mar. 5, 2018.

1 Introduction

The passage detection of an object represents a widely diffused measurement in industrial applications, and it is typically implemented by light barriers (when we have accessibility on both sides) or proximity sensors. Different techniques are employed for realizing proximity sensors, based on measurement of electric or magnetic field (inductive or capacitive sensors), ultrasonic waves or through optical approaches.¹ Optoelectronic detectors are widely diffused, because they do not require metal targets such as inductive sensors, and they are faster than capacitive ones. The optical sensor can be also very low-cost, and it typically shows a good spatial resolution, when compared to ultrasound devices. Indeed, in a short range up to a few centimeters, a simple optical sensor can detect a target by measuring the backdiffused light² through a photodetector. However, background rejection is a main limit for this kind of sensors: the applications often require to ignore the presence or the movement of other objects, placed further away. To overcome this problem, triangulation technique is typically adopted. It can eliminate spurious signal, due to objects presence out of the desired measurement range.³ Drawbacks of this approach are setup and signal elaboration complexity, need for a certain angle of view, and growing of the cost. In addition, a configuration with multiple triangulator sensors requires custom design to prevent interference among sources.

The detector proposed in this work takes advantage of self-mixing configuration⁴⁻⁶ and overcomes these problems in a very compact and low-cost setup. Self-mixing technique has been widely applied for measurement of absolute distance,^{7,8} displacements,^{9,10} vibrations,^{11,12} and flux.¹³⁻¹⁵ This optical configuration has several advantages: setup simplicity, compactness, low-cost, good resolution-dynamic trade-off, and insensitivity to ambient noise. Thus, it is

potentially suitable for contact-less detection in a variety of applications.

Recently, a different effect, related to self-mixing, was described in Ref. 16 and explained in Ref. 17: when the target is close to the laser diode (LD) and the back-injection is quite high, it induces an amplitude modulation that does not depend on the phase.¹⁷ In this contribution, we take advantages of this particular effect, together with the classic self-mixing effect, to realize a proximity sensor for the detection of an object passing, in a defined detection range.

2 Proximity Effect

The self-mixing effect occurs when a fraction between 10^{-6} and 10^{-3} of LD beam is backreflected into the cavity itself.⁴ In that case, the emitted power is modulated and an interferometric signal is observed across the LD junction¹⁸ or through a normal photodiode. As expected for any kind of interferometer, the signal depends on the phase shift between the generated beam and the reflected one. The emitted power P is modulated by $F(\phi)$, a periodic function of phase $\phi = 2ks$, where $k = 2\pi/\lambda$, s is the target distance, and λ is the LD wavelength. However, a second effect has been recently discussed in literature:¹⁷ power amplification is produced when a large amount of light is coupled back into the laser. This effect is evident when the reflected power is higher than about 1% and can be explained considering that external cavity changes the loss per transit time.¹⁷ The photon lifetime τ_p can be expressed as function of target power reflectivity R_3 and LD mirrors power reflectivities R_1 , R_2 :

$$\tau_p \approx \tau_{in} \{-\ln R_1 [R_2 + (1 - R_2)^2 R_3 / (1 - R_2 R_3)]\}^{-1}. \quad (1)$$

For an unperturbed cavity ($R_3 = 0$), we obtain as follows:

$$\tau_{p0} \approx \tau_{in} \{-\ln R_1 R_2\}^{-1}. \quad (2)$$

*Address all correspondence to: Michele Norgia, E-mail: michele.norgia@polimi.it

From Eqs. (1) and (2), τ_p rises up with the target reflectivity R_3 . Moreover, the well-known Lang–Kobayashi (L-K) equations¹⁹ show that the slope efficiency S and current threshold I_{th} are both affected by changes on photon lifetime τ_p :

$$\frac{\Delta S}{S} = \frac{\Delta \tau_p}{\tau_{p0}}; \quad \frac{\Delta I_{th}}{I_{th}} = \frac{\Delta \tau_p}{\tau_{p0}} (1 + GN_0 \tau_{p0}). \quad (3)$$

From Eq. (3), we get threshold variations induced by lifetime variations but scaled by a factor $(1 + GN_0 \tau_{p0})$, whereas relative slope variations follow exactly the lifetime variations.

In conclusion, the emitted power P increases with backinjection and threshold current I_{th} lows down as well. In order to validate the theory, we organized a simple experiment: a cylindrical aluminum target was moved transversally in front of the LD. Figure 1 shows the LD power variation during the movement, measured by the monitor photodiode (PD) (upper curve) and also by the voltage across the LD (lower curve). The transimpedance gain of the PD is 100 k Ω and the voltage gain is 1000, AC coupled. The optical power and the LD voltage show an identical dependence

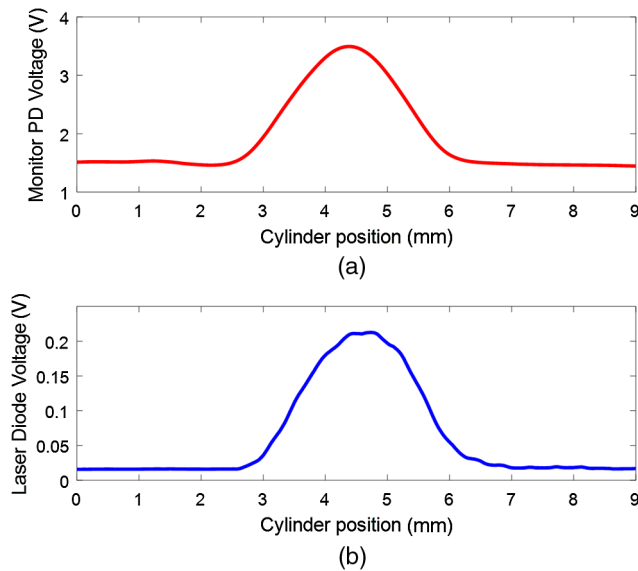

Fig. 1 Monitor (a) photodiode signal (upper curve) and (b) LD voltage (lower curve), in correspondence to the movement of an aluminum cylinder in front of the LD.

on the cylinder position, because the signal amplitude depends on the relative angle α of the reflecting surface (R_3 increases when the target is aligned). This effect was used in Ref. 17 for measuring very small angles with high accuracy. As expected, it is not a function of the interferometric phase ϕ . The effect intensity decreases with target distance, due to reduction of collected power. The measurement of voltage signal across the LD confirms that the effect involves LD dynamics: sometimes the monitor photodiode can collect directly a fraction of the reflected power and show a not-real LD power variation, but this is not the case.

In conclusion, the optical power P is modulated by this gain effect, depending only on the power backinjected, and by the self-mixing effect, periodic function of s , with shape depending on the feedback level.⁴⁻⁶ The two effects can occur simultaneously and their combination depends on the optical configuration. It is worth to note that both effects are not sensitive to light coming from other sources, including other LDs.

3 Proximity Sensor

The aim of this contribution is to realize a proximity sensor, able to cover the full dynamic from 0 to 10 cm by combining the two effects, and taking advantage of the intrinsic simplicity of a self-mixing sensor setup. To do so, we divide the sensor whole range in two parts: in the first one, the target presence is detected by measuring the power gain variation; in the second one, it is detected by means of modulation induced by the self-mixing effect. The self-mixing detector can work at high frequency, as already demonstrated in literature,⁹ therefore, the target can move in front of the LD also at high-speed (up to some tens of meter per second). Figure 2 shows the sensor scheme, a single optical channel configuration composed just by the LD source and a focusing lens. The experiments are carried out on a very low-cost Fabry–Perot laser operating at 650 nm with 5-mW power output. Focus position determines detector sensitivity and range.

The main point regards the self-mixing effect, which is particularly sensitive to the focus position. Self-mixing signal from a diffusive target is strong when the target is placed close to the focus position. On the contrary, the gain effect is maximum when the target is very close to the LD. Farther away from the focus position, both effects vanish due to the light beam divergence. It means that the sensor is not sensitive to a target moving outside from the sensing range. Experimental results for our setup show that self-mixing effect occurs from about 20 mm before up to 20 mm after

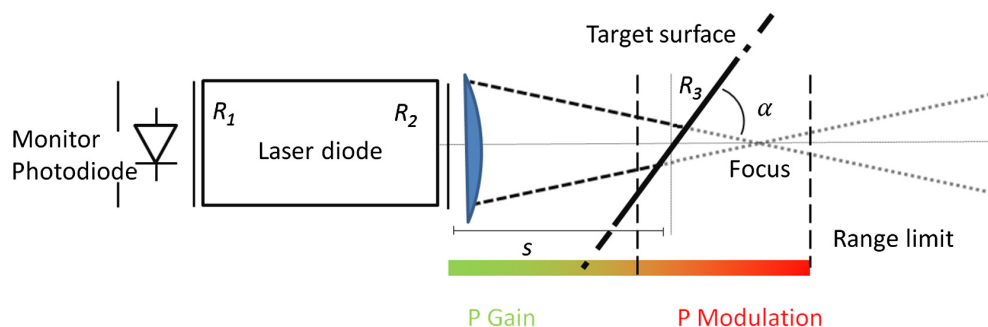

Fig. 2 Schematic of sensor: target surface reflects LD beam focused by the lens. The amount of light rejected back into the cavity depends on α and s . The equivalent reflectivity R_3 determines the range in which the two effects occur.

the focus position (at about 5 cm from the LD). Consequently, the detector is blind after a given distance, about 8 cm in our setup. In this case, the background rejection is automatic. For the target positions very close to the LD, the detection is guaranteed by the gain power variation: experimentally, we see that the effect allows detecting the movement of metallic objects from 0 mm up to 45 mm. After that distance, the reflected light collected by the lens is too low to induce the phenomenon.

According to this, we placed the focus at 50 mm in order to measure from 0 to 80 mm without lack of continuity: the gain effect works from 0 mm to about 45 mm and self-mixing effect from about 35 to about 80 mm. In the region between 35 and 45 mm, the signal is caused by the combination of the two effects. Figures 3–7 show the signal evolution as a function of the target distance, from 10 to 70 mm. In this case, the target was a metallic cylinder, with diameter 1 cm, moved transversally in front of the sensor at a speed of about 5 m/s. In Figs. 3 and 4, we can appreciate a pure gain effect, whereas Fig. 5 shows a combination of gain effect and self-mixing. Figures 6 and 7 show a pure self-mixing effect: the signal seems to be noise-like, because the interferometric fringes are at high-frequency and modulated by the speckle effect. For the proposed application, this is not a problem, because we are looking at the target presence, not at its speed or distance.

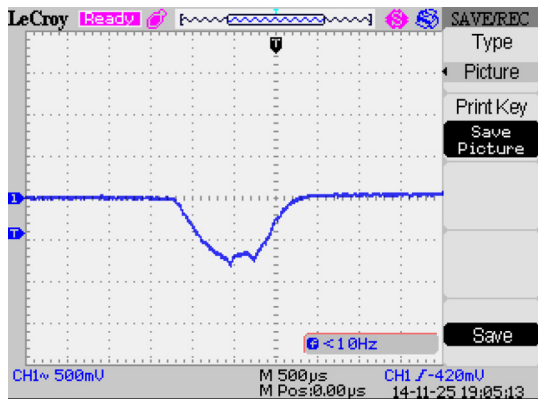

Fig. 3 Signal acquired from the monitor PD, in correspondence to a target transit at 1 cm from the LD.

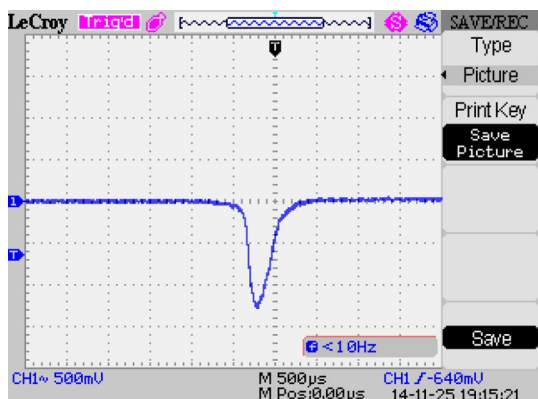

Fig. 4 Signal acquired from the monitor PD, in correspondence to a target transit at 3 cm from the LD.

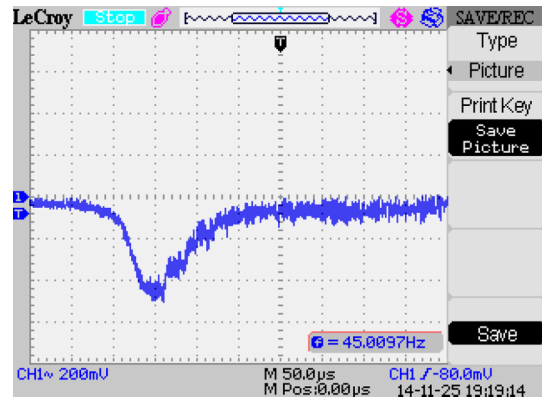

Fig. 5 Signal acquired from the monitor PD, in correspondence to a target transit at 4 cm from the LD.

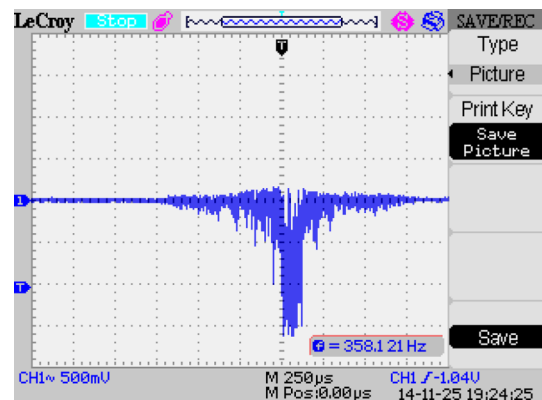

Fig. 6 Signal acquired from the monitor PD, in correspondence to a target transit at 5 cm from the LD (focus position).

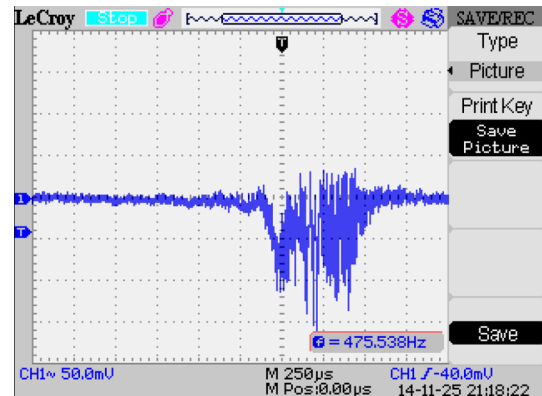

Fig. 7 Signal acquired from the monitor PD, in correspondence to a target transit at 7 cm from the LD.

Starting from the signals depicted in Figs. 3–7, it is easy to get a target-presence signal by an analog processing. After the PD signal amplification by the means of a transimpedance amplifier (amplification factor 100 k Ω), an analog comparator generates pulses when the signal exceeds a fixed threshold. For the target detection, the sensitivity depends on the threshold level, set for the comparator. The empiric procedure for getting the maximum sensitivity consists in setting the threshold at the lower level without erroneous detections. In this case, the threshold value was

set to $V_{th} = 25$ mV in order to avoid spurious detections due to noise. After the comparator, a monostable multivibrator keeps the signal output in the high state for 2 ms. In that way, false acquisitions due to multiple fringes or spikes are neglected. However, this choice limits the frequency measurement to 500 detections per second. In other words, the sensor intrinsically undergoes a trade-off between maximum measurement frequency and maximum duration of the single detection. It is worth noting that the proposed sensor is neither able to measure distance nor velocity. It is designed for the detection of a passing object, as an alternative to low-cost optical proximity sensors, realized by a LED and a photodiode. A target with specular surface can induce detection problems if not properly aligned, but this problem is common for almost all the optical system measuring the diffused light.

We applied the functioning principle discussed to carry out real industrial tests. The aim was monitoring frequency rotation of a washing machine spinner, by measuring the period between spokes, each one 1.5 cm wide. Figure 8 shows the scheme of the measurement setup. The maximum rotation frequency of the washing machine was about 80 Hz, which means a period of around 2.5 ms between the spokes. The distance range was from 0 to 80 mm and the washing machine plastic structure (background for the sensor) was 30 mm away from the spinner. In order to get the rotation direction, a second LD sensor was added, placed 10 mm away from the first one in the spokes movement direction. As explained before, the sensor is based on a coherent detection, and it is possible to use the same LD model for both sources, without any crosstalk between sensors.

In the realized sensors, the analog signal is digitally converted and a microprocessor directly calculates the rotation frequency by the means of digital counters. The trigger order of the two sensors outputs determines the rotation direction. The system includes also an ultrasound distance sensor and a positioning motor (Fig. 8), for automatically placing the sensors on the washing machine to be monitored. In this way, the system can work automatically in a diagnostic chain: the purpose is to control if the washing machine works properly.

A measurement campaign was carried out at different distances and for different rotation speed. The root mean square

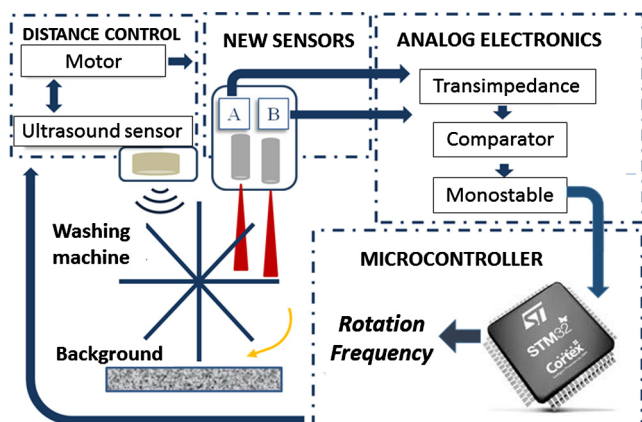

Fig. 8 System scheme for the monitoring of a washing machine. On the left, the range-finder controls the step motor to select the working range of sensors. Lasers A and B are aligned with the target blades. Two analog circuits return periodic square waves read and elaborated by the microcontroller for measuring the rotation speed.

error on rotation speed was about 10^{-4} , with maximum error limited to 3×10^{-4} . The sensor can always discriminate the rotation direction successfully, demonstrating that the two sensors do not interfere. Moreover, background rejection was experimentally validated: the vibrations of the objects placed 3 cm after the focus position were never detected.

Before realizing the proposed sensor, this particular measurement was attempted with different low-cost optical sensors but without success. The majority of commercial sensors were not able to measure the high-speed passing of the spokes, often they see the background movement as false detection, and there was no possibility to place two sensors in close proximity, in order to detect the rotation direction, without interference.

4 Conclusions

A laser proximity sensor, based on two different coherent effects, is designed and demonstrated. The main advantages of the proposed system are compactness, easiness of operation, self-aligning, very low-cost (in the order of 1 €), and insensitivity to straight light and to different light sources. In both detection ranges, the measurement is due to a coherent effect. As a result, the ambient light from different sources is neglected, and the detector exhibits strong robustness against light noise. Multiple sensor devices can be easily developed, simply by replying the same stage, also with same LD models. Therefore, laser beams crossing is permitted and filters are not necessary. The self-mixing detector, also, has an excellent capability of tracking high frequency movement and is applicable to high-speed moving objects.

References

1. J. Fraden, *Handbook of Modern Sensors*, 5th ed., Springer, Cham (2016).
2. G. Berkovic and E. Shafir, "Optical methods for distance and displacement measurements," *Adv. Opt. Photonics* **4**, 441–471 (2012).
3. S. Donati, *Electro-Optical Instrumentation—Sensing and Measuring with Lasers*, Prentice Hall, Upper Saddle River (2004).
4. G. Giuliani et al., "Laser diode self-mixing technique for sensing applications," *J. Opt. A Pure Appl. Opt.* **4**(6), S283–S294 (2002).
5. C. Bes, G. Plantier, and T. Bosch, "Behavioral model of a self-mixing laser diode sensor," *IEEE J. Quantum Electron.* **41**(9), 1157–1167 (2005).
6. T. Taimre et al., "Laser feedback interferometry: a tutorial of the self-mixing effect for coherent sensing," *Adv. Opt. Photonics* **7**, 570–631 (2015).
7. M. Norgia, A. Magnani, and A. Pesatori, "High resolution self-mixing laser rangefinder," *Rev. Sci. Instrum.* **83**, 045113 (2012).
8. T. Bosch et al., "Three-dimensional object construction using a self-mixing type scanning laser range finder," *IEEE Trans. Instrum. Meas.* **47**, 1326–1329 (1998).
9. A. Magnani, A. Pesatori, and M. Norgia, "Real-time self-mixing interferometer for long distances," *IEEE Trans. Instrum. Meas.* **63**(7), 1804–1809 (2014).
10. C. Bes, G. Plantier, and T. Bosch, "Displacement measurements using a self-mixing laser diode under moderate feedback," *IEEE Trans. Instrum. Meas.* **55**, 1101–1105 (2006).
11. A. Magnani, A. Pesatori, and M. Norgia, "Self-mixing vibrometer with real-time digital signal elaboration," *Appl. Opt.* **51**(21), 5318–5325 (2012).
12. U. Zabit et al., "Adaptive self-mixing vibrometer based on a liquid lens," *Opt. Lett.* **35**, 1278–1280 (2010).
13. M. Norgia, A. Pesatori, and L. Rovati, "Self-mixing laser Doppler spectra of extracorporeal blood flow: a theoretical and experimental study," *IEEE Sens. J.* **12**(3), 552–557 (2012).
14. M. Norgia, A. Pesatori, and S. Donati, "Compact laser diode instrument for flow measurement," *IEEE Trans. Instrum. Meas.* **65**(6), 1478–1483 (2016).
15. L. Campagnolo et al., "Flow profile measurement in microchannel using the optical feedback interferometry sensing technique," *Microfluid. Nanofluid.* **14**, 113–119 (2013).

16. T. Tambosso, R. Horng, and S. Donati, "Curvature of substrates is measured by means of a self-mixing scheme," *IEEE Photonics Technol. Lett.* **26**(21), 2170–2172 (2014).
17. S. Donati, D. Rossi, and M. Norgia, "Single channel self-mixing interferometer measures simultaneously displacement and tilt and yaw angles of a reflective target," *IEEE J. Quantum Electron.* **51**(12), 1–8 (2015).
18. Y. L. Lim et al., "Self-mixing flow sensor using a monolithic VCSEL array with parallel readout," *Opt. Express* **18**, 11720–11727 (2010).
19. R. Lang and K. Kobayashi, "External optical feedback effects on semiconductor injection laser properties," *IEEE J. Quantum Electron.* **16**(3), 347–355 (1980).

Dario Melchionni graduated in electronic engineering from Politecnico di Milano in 2012 and obtained his PhD degree in information engineering from Politecnico di Milano in 2015. During his PhD thesis, he worked on optical sensors and self-mixing interferometry.

Alessandro Pesatori is an associate professor at Politecnico di Milano, Italy. He received his MSc degree in biomedical engineering at Politecnico di Milano in 2004. In 2008, he obtained his PhD degree in information engineering at Politecnico di Milano. His main research interests are optical and electronic measurements with biomedical applications.

Michele Norgia is a full professor at Politecnico di Milano, Italy. He graduated with honors in electronic engineering from the University of Pavia in 1996, and joined Politecnico di Milano in 2006. He has authored over 150 papers published in international journals or conference proceedings. His main research interests are optical and electronic measurements. He is senior member of IEEE.