













Systematics and character evolution of capitate hydrozoans

Davide Maggioni^{*a,b,c} , Peter Schuchert^d , Andrew N. Ostrovsky^{e,f} ,
 Andrea Schiavo^g , Bert W. Hoeksema^{h,i} , Daniela Pica^j , Stefano Piraino^{k,l,m} ,
 Roberto Arrigoniⁿ , Davide Seveso^{b,c,m} , Enrico Montalbetti^{b,c} , Paolo Galli^{b,c,m} 
 and Simone Montano^{b,c,m} 

^aDepartment of Biotechnology and Biosciences (BtBs), University of Milano-Bicocca, Milan 20126, Italy; ^bDepartment of Earth and Environmental Science (DISAT), University of Milano-Bicocca, Milan 20126, Italy; ^cMarine Research and Higher Education (MaRHE) Center, University of Milano-Bicocca, Faafu Magoodhoo Island 12030, Maldives; ^dMuséum d'Histoire Naturelle, Geneva 1208, Switzerland; ^eDepartment of Invertebrate Zoology, Faculty of Biology, Saint Petersburg State University, Saint Petersburg 199034, Russia; ^fDepartment of Palaeontology, Faculty of Earth Sciences, Geography and Astronomy, University of Vienna, Vienna 1090, Austria; ^gDepartment of Electronics, Information and Bioengineering, Polytechnic University of Milan, Milan 20133, Italy; ^hMarine Evolution and Ecology Group, Naturalis Biodiversity Center, Leiden 2333 CR, The Netherlands; ⁱGroningen Institute for Evolutionary Life Sciences, University of Groningen, Groningen 9747 AG, The Netherlands; ^jDepartment of Integrative Marine Ecology, Stazione Zoologica Anton Dohrn, Calabria Marine Centre, Amendolara 87071, Italy; ^kDepartment of Biological and Environmental Sciences and Technologies (DiSTeBA), University of Salento, Lecce 73100, Italy; ^lNational Interuniversity Consortium for Marine Science (CoNISMa), Rome 00196, Italy; ^mNational Biodiversity Future Center (NBFC), Palermo 90133, Italy; ⁿDepartment of Biology and Evolution of Marine Organisms (BEOM), Genoa Marine Centre (GMC), Stazione Zoologica Anton Dohrn – National Institute of Marine Biology, Ecology and Biotechnology, Genoa 16126, Italy

Received 31 May 2023; Revised 6 October 2023; Accepted 19 November 2023

Abstract

Capitate hydrozoans are a morphologically and ecologically diverse hydrozoan suborder, currently including about 200 species. Being grouped in two clades, Corynida and Zancleida, these hydrozoans still show a number of taxonomic uncertainties at the species, genus and family levels. Many Capitata species established symbiotic relationships with other benthic organisms, including bryozoans, other cnidarians, molluscs and poriferans, as well as with planktonic dinoflagellates for mixotrophic relationships and with bacteria for thiotrophic ecosystems. Our study aimed at providing an updated and comprehensive phylogeny reconstruction of the suborder, at modelling the evolution of selected morphological and ecological characters, and at testing evolutionary relationships between the symbiotic lifestyle and the other characters, by integrating taxonomic, ecological and evolutionary data. The phylogenetic hypotheses here presented shed light on the evolutionary relationships within Capitata, with most families and genera being recovered as monophyletic. The genus *Zanclaea* and family Zancleidae, however, were divided into four divergent clades, requiring the establishment of the new genus *Apatizanclaea* and the new combinations for species in *Zanclaea* and *Halocoryne* genera. The ancestral state reconstructions revealed that symbiosis arose multiple times in the evolutionary history of the Capitata, and that homoplasy is a common phenomenon in the group. Correlations were found between the evolution of symbiosis and morphological characters, such as the perisarc. Overall, our results highlighted that the use of genetic data and a complete knowledge of the life cycles are strongly needed to disentangle taxonomic and systematic issues in capitate hydrozoans. Finally, the colonization of tropical habitat appears to have influenced the evolution of a symbiotic lifestyle, playing important roles in the evolution of the group.

© 2023 The Authors. *Cladistics* published by John Wiley & Sons Ltd on behalf of Willi Hennig Society.

Introduction

The Hydrozoa is one of the six currently accepted classes of the phylum Cnidaria (Kayal et al., 2018;

WoRMS Editorial Board, 2023), showing an incredible diversity of taxa, morphologies, life cycles and ecological preferences (Bouillon et al., 2006). This class has been estimated to be the second most species-rich within Cnidaria, after Anthozoa (Appeltans et al., 2012), and new taxa are continually being added (e.g. Toshino

*Corresponding author:
 Email: davide.maggioni@unimib.it

et al., 2019; Galea and Maggioni, 2020; Maggioni et al., 2021; Tödter et al., 2023). Yet, part of its diversity is still unknown (Appeltans et al., 2012), also as a consequence of the pervasive occurrence of morphologically cryptic species (Postaire et al., 2016, 2017; Maggioni et al., 2020a, 2022a). However, recent broad-scale molecular studies have started to shed light on the evolutionary affinities of genera, families, and taxa at a higher level, clarifying phylogenetic relationships that were unclear or established solely based on morphology (e.g. Maronna et al., 2016; Munro et al., 2018; Bentlage and Collins, 2021).

The evolutionary history of some hydrozoan taxa remains elusive, owing to low sampling effort compared to extant diversity or to ineffective molecular markers that are not able to disentangle deeper relationships. An example is the suborder Capitata, currently containing about 200 accepted extant species (Schuchert, 2023), and showing several uncertainties at the species, genus and family levels. This suborder was also previously thought to include the now separated group Aplanulata, which was demonstrated to diverge from Capitata s.s., constituting a different suborder also including the model organisms *Hydra* spp. (Collins et al., 2005). Within Capitata, two major clades were identified by Nawrocki et al. (2010), namely the Zancleida and Corynida. On the one hand, the previous phylogenetic assessments of Capitata mostly focused on Corynida (Collins et al., 2005; Nawrocki et al., 2010), which contains two families, Corynidae Johnston, 1836 and Cladonematidae Gegenbaur, 1857. Despite several taxonomic and systematic issues being clarified by Nawrocki et al. (2010), some relationships are still uncertain and many genera and species are currently lacking DNA data. Zancleida, on the other hand, shows a greater family and genus diversity, and some recent works focused on the diversity and evolution of certain families or clades (Miglietta et al., 2019; Maggioni et al., 2021, 2022b). A striking example of taxonomic and systematic uncertainties in Zancleida is represented by the family Zancleidae Russell, 1953, the most diverse of the clade, which has been demonstrated to be polyphyletic and to contain several cryptic species (Maggioni et al., 2018, 2020a, 2022a). The taxonomy of this family is challenging for several reasons, including the conserved general morphology, the presence of poor-quality descriptions, and the limited knowledge of the life cycles for several species (Maggioni et al., 2018).

Capitata shows a large variation in morphologies of polyps and medusae, habitats in which they live, and ecological relationships that they establish. For instance, regarding the morphology, different types of polyps and colonies evolved in the group, including stolonial, erect, or even completely pelagic colonies, and some species also show polymorphic polyps

(Petersen, 1990; Boero et al., 2000; Bouillon et al., 2006). Most species have a chitinous structure, the perisarc, covering at least the hydrorhiza, whereas some Zancleida species completely lost this structure (Bouillon et al., 2006). The cnidome also is variable among Capitata groups, and for some taxa it is considered an important diagnostic character (Gravili et al., 1996). The reproductive stages show variable levels of reduction, ranging from completely developed, freely swimming and feeding medusae, to reduced medusoids that can be released or not from the parental polyps, and to sporosacs (Petersen, 1990; Schuchert, 2001; Bouillon et al., 2006). The geographical distribution of Capitata as a whole is circumglobal, from polar to tropical regions and from shallow to deep waters (Peña Cantero et al., 2013; Ronowicz et al., 2013; Montano et al., 2015a; Mastrototaro et al., 2016), with some species showing wide distributional ranges, and others only known from restricted localities (e.g. Maggioni et al., 2017, 2021, 2022b; Miglietta et al., 2019).

Another source of variation in the Capitata is represented by the substrate on which polyps live. Indeed, many species establish symbiotic relationships with other benthic organisms, living on or partially embedded in their hosts, which can be algae, crustaceans, bryozoans, molluscs, polychaetes, poriferans, or other cnidarians such as scleractinian corals and octocorals (Puce et al., 2008). The host specificity of these symbiotic species is variable, with both generalist and specialist taxa (Maggioni et al., 2022a, b), and in some cases the relationships appear to be very intimate, with the hosts showing specific structural modifications (Puce et al., 2005; Manca et al., 2019; Maggioni et al., 2020b). Both mutualistic and parasitic associations are known, with some species in the genus *Zanclea* Gegenbaur, 1856, for example, protecting their hosts from predators (Osman and Haugness, 1981; Montano et al., 2017) and at least one *Halocoryne* species feeding on the lophophores of the host bryozoans (Piraino et al., 1992). In most cases, the nature of these associations is still unclear. Additional types of mutualistic symbiotic relationships are known in capitate hydrozoans: for example, *Millepora* spp. and *Velella velella* (Linnaeus, 1758) hosting dinoflagellate symbionts in their endodermal cells (Banaszak et al., 1993; Di Camillo et al., 2017), or the thiotrophic ectosymbiosis of two sulfur-oxidizing bacteria attached to the tentacles of *Cladonema* sp. hydroids (Abouna et al., 2015).

The establishment of symbiotic relationships has been hypothesized to have influenced the evolution of the involved organisms, in terms of morphological and behavioural adaptations. Piraino et al. (1992) put forward the hypothesis that, at least in the symbiotic relationships between hydroids and bryozoans, mutualism originated from simple epibiosis, and parasitism from

mutualism. Accordingly, Boero et al. (2000) proposed an evolutionary trend in Zancleidae species, from non-symbiotic, monomorphic species with a typical *Zancklea* morphology in both polyp and medusa, to obligate symbiotic species with modified polymorphic polyps, a medusa that is more or less reduced, and behavioural integrations with the host. Later, Puce et al. (2002) pinpointed another interesting trend in zancleid symbiotic species related to modifications of the hydrorhiza. Specifically, they hypothesized a shift from generalist species growing on a variety of substrates, and with a hydrorhiza protected by the chitinous perisarc, to specialist species (e.g. associated with bryozoans) with the hydrorhiza growing inside/being surrounded by the host skeleton and without protective perisarc as a consequence of the defensive action exerted by the host (also discussed in Bogdanov et al., 2022). These possible adaptations to the symbiotic lifestyle also may have appeared convergently in other hydrozoan groups (Puce et al., 2008). For instance, polymorphic colonies, reduced polyps and absence of perisarc covering the hydrorhiza are known in symbiotic filiferan species associated with molluscs, crustaceans, polychaetes and fish (Hand and Hendrickson, 1950; Boero et al., 1991; Puce et al., 2004; Miglietta and Cunningham, 2012). Likewise, all species specifically associated with the seagrass *Posidonia oceanica* (Linnaeus) Delile, 1813 lack the ability to produce free-swimming medusae (Boero, 1987). Interestingly, Leclère et al. (2009) showed that the evolution of the life cycles in leptothecate hydrozoans does not follow a phyletic gradualism model, with, for instance, medusa loss preceded by medusa reduction in the form of a medusoid. Instead, the evolution of life cycles is characterized by independent events of simplification and re-acquisition of the medusa stage (Boero and Sarà, 1987; Leclère et al., 2009), as exemplified by the re-invention of the medusa in *Obelia* (Péron & Lesueur, 1810), with its peculiar apomorphies including the absence of a velum, the chordal tentacles and the special orientation of striated muscle cells (Boero and Sarà, 1987). This evolutionary scenario also may apply to the evolution of other hydrozoan characters.

In order to clarify the occurrence and origin of life-history traits within Capitata, the present study has two main aims, namely (i) the clarification of its phylogenetic relationships, and (ii) the assessment of the evolution of different ecological and morphological features in the group. In this case, ecological traits mainly concern symbiotic relationships with other organisms, as also shown by, for example, corallivorous parasitic snails (Gittenberger and Hoeksema, 2013; Potkamp et al., 2017), symbiotic palaemonid shrimps (Horká et al., 2016), coral-dwelling barnacles (Dreyer et al., 2022) and anthozoan zoantharians (Kise et al., 2023). New genetic data were collected and

analysed together with available DNA sequences to produce the most comprehensive phylogenetic hypothesis for the suborder. The obtained phylogeny reconstruction was then used to model the evolution of selected characters, including the morphological features, the symbiotic lifestyle and the habitat type. Finally, evolutionary relationships between the symbiotic lifestyle and the other characters were tested.

Material and methods

Sampling and morphological assessment

Sampling was carried out by snorkelling and SCUBA diving (0–30 m deep) between October 2014 and December 2019 in various localities across the Indo-Pacific, Atlantic and Mediterranean Sea (Table S1), and mostly targeted polyp and medusa stages of the Zancleida (Fig. 1). When hydrozoan polyps were observed, fragments of the substrate and associated hydroids were collected using hammer and chisel or a diving knife. Before manipulation, hydroids were anaesthetized using menthol crystals, photographed, and detached from the substrate using forceps, syringe needles and micropipettes, and fixed in 99% ethanol for genetic analyses and in 10% formalin (= water solution of 4% formaldehyde) for morphological assessments. When possible, polyps were reared in oxygenated bowls to allow for medusae release, but in a few cases, medusae were directly collected from the environment.

Specimens were observed and photographed under a EZ4 D stereo microscope (Leica, Wetzlar, Germany) to perform species identification and to describe their general morphology, and under a Axioskop 40 compound microscope (Zeiss, Oberkochen, Germany) to characterize fine-scale structures of polyps and medusae and cnidocysts. Both microscopes were equipped with a PowerShot G7 X Mark II camera (Canon, Tokyo, Japan). Measurements were performed using the ImageJ 1.52p software (see Schneider et al., 2012).

When symbiotic species occurred, hosts were identified to the lowest taxonomic level possible. In particular, to identify host bryozoan species, tissues were removed by immersion in a 10% sodium hypochlorite solution for up to 12 h, skeletons were rinsed, air-dried, sputter-coated with gold, and observed under a Gemini SEM 500 scanning electron microscope (Zeiss, Oberkochen, Germany) (see Grischenko et al., 2022).

The present work is registered in ZooBank under: <http://zoobank.org/urn:lsid:zoobank.org:pub:3D9D9A6D-183C-4397-8D60-810E2B6166D2>.

DNA extraction, sequencing and dataset assembly

Genomic DNA was extracted from single ethanol-fixed polyps or medusae following the protocol described in Maggioni et al. (2022a) and six gene regions were amplified. Specifically, portions of the mitochondrial large ribosomal RNA (16S rRNA), cytochrome *c* oxidase subunit I (COX1), cytochrome *c* oxidase subunit III (COX3), and nuclear small ribosomal RNA (18S rRNA), large ribosomal RNA (28S rRNA), internal transcribed spacer (ITS; including partial ITS1, 5.8S and partial ITS2 regions) were amplified using the primers and protocols described in Maggioni et al. (2020a). Amplification success was assessed through 1.5% agarose electrophoretic runs. PCR products were purified with Illustra ExoStar (GE Healthcare, Amersham, UK) and finally sequenced with an ABI 3730xl DNA Analyser (Applied Biosystems, Carlsbad, CA, USA) in both

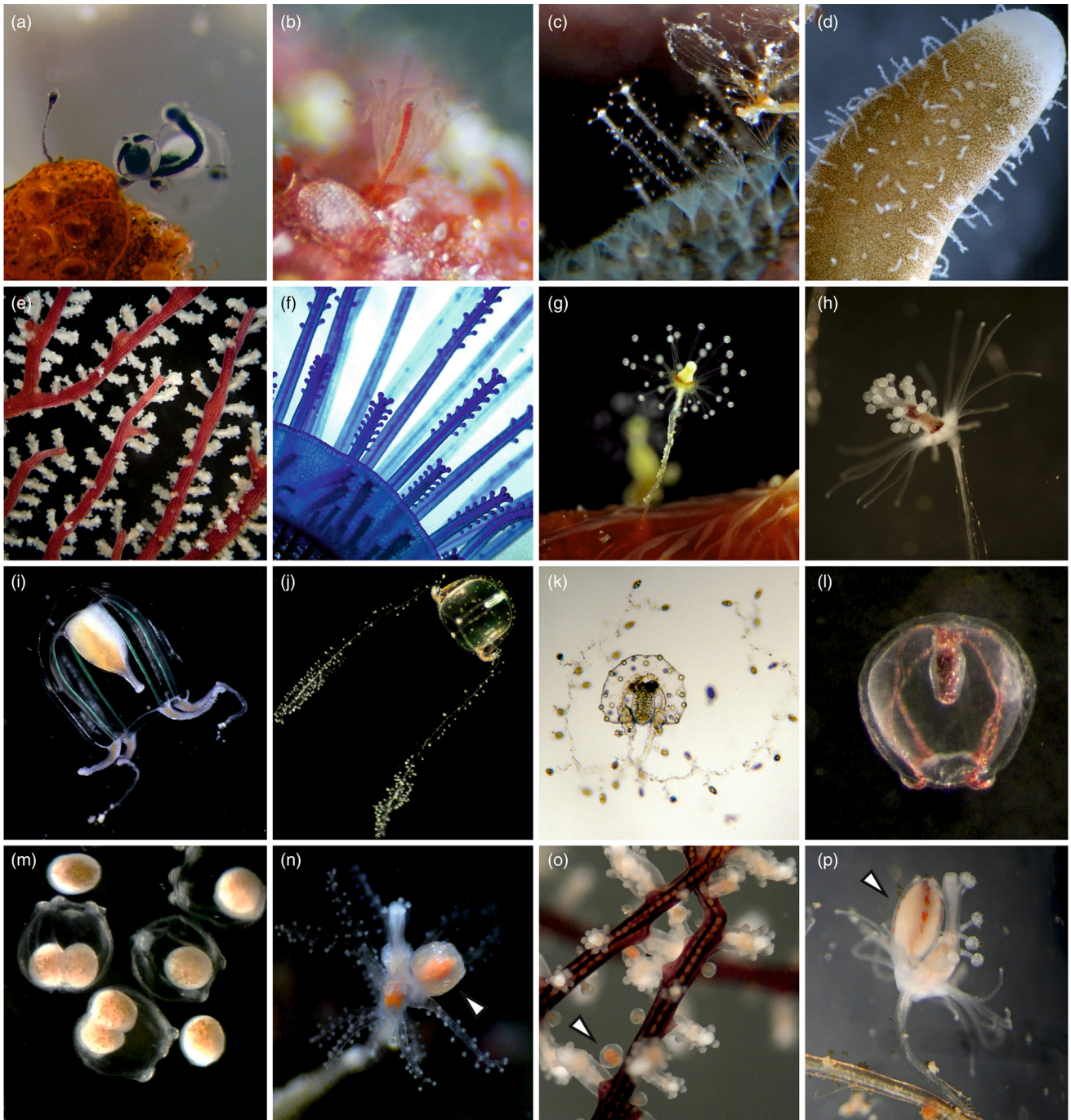

Fig. 1. Morphological diversity of the Zancleida species. (a) Reduced and polymorphic polyps of *Halocoryne epizoica* associated with *Schizobrachyella sanguinea* (Tricase, Italy, Mediterranean Sea), and (b) *Zanclea pirainoid* associated with *Robertsonidra* sp. (Magoodhoo, Maldives, Indian Ocean). (c) Polyps of *Zanclea giancarloii* associated with *Adeonella* sp. (Corfu, Greece, Mediterranean Sea). (d) *Millepora dichotoma* (Yanbu, Saudi Arabia, Red Sea). (e) *Solanderia gracilis* (Bocas del Toro, Panama, Caribbean Sea). (f) *Porpita porpita* (Magoodhoo, Maldives, Indian Ocean). (g) *Sphaerocoryne bedoti* associated with a sponge (Magoodhoo, Maldives, Indian Ocean), and (h) *Pennaria disticha* (Daranboodhoo, Maldives, Indian Ocean). Medusa stages of (i) *Zanclea* sp. (Villefranche-sur-Mer, France, Mediterranean Sea), (j) *Pseudozanclea timida* (Daranboodhoo, Maldives, Indian Ocean) and (k) *Apatizanclea* sp. 1 (Magoodhoo, Maldives). Medusoids of (l) *Halocoryne epizoica* (Tricase, Italy, Mediterranean Sea), and (m) *Millepora dichotoma* (Thuwal, Saudi Arabia, Red Sea). Medusoids (arrowheads) attached to parental polyps of (n) *Cladocoryne haddoni* (Bileddhoo, Maldives, Indian Ocean), (o) *Solanderia secunda* (Thuwal, Saudi Arabia, Red Sea), and (p) *Pennaria disticha* (Bocas del Toro, Panama, Caribbean Sea).

directions. Geneious 7.1.9 (Biomatters, Auckland, New Zealand) was used to check, correct and assemble the chromatograms, and to translate the protein-coding genes (COX1 and COX3) to control for the presence of stop codons. The obtained consensus sequences were deposited in GenBank (Table S1).

Additional sequences were downloaded from GenBank, including all available sequenced specimens for the family Zancleidae and one specimen for each other Capitata species (Table S1). Even though many species were represented by only one or a few sequences obtained from GenBank, they were included in the analyses in order to obtain the most comprehensive dataset possible in terms of taxonomic diversity at the species, genus and family levels.

Sequences of each DNA region were aligned using MAFFT 7.110 (Katoh and Standley, 2013) with the E-INS-i option, after adding *Eudendrium racemosum* (Cavolini, 1785) as outgroup. The 16S, 18S, 28S and ITS alignments were run through Gblocks (Castresana, 2000; Talavera and Castresana, 2007) using the “less stringent” settings to remove ambiguously aligned regions (Table S2). Finally, alignments were concatenated using Mesquite 3.2 (Maddison and Maddison, 2006).

Initially, all sequences were included in the downstream phylogenetic analyses to assess the phylogenetic position of the Zancleidae species within Capitata, owing to the known polyphyly of the family (Maggioni et al., 2018). Subsequently, a single specimen per species was maintained to obtain the presented phylogenetic hypotheses for the Capitata. For each Zancleidae clade, phylogenetic analyses were also run separately including all available sequenced specimens and using *Porpita porpita* (Linnaeus, 1758), *Millepora dichotoma* Forsskål, 1775 and *Pseudozanclea timida* (Puce, Di Camillo & Baves-trello, 2008) as outgroups.

Phylogenetic analyses

Substitution models and partitions were determined with Partition-Finder 1.1.1 (Lanfear et al., 2012) using the Akaike information criterion (AIC), resulting in partitioning by gene and codon (for protein-coding genes) and in the selection of the GTR + I + G for all partitions. Phylogeny reconstructions were performed using maximum parsimony (MP), maximum likelihood (ML) and Bayesian inference (BI). MP analyses were carried out using tree searches performed in TNT 1.6 (Goloboff, 1999; Nixon, 1999; Goloboff et al., 2008) with 10000 random addition sequences, each employing 100 cycles of sectorial searches, ratcheting, drifting and tree fusing. Gaps were treated as missing data. Resampling was performed with 10000 bootstrap replicates. ML analyses were run using RAxML 8.2.12 (Stamatakis, 2014) with 1000 non-parametric bootstrap replicates. BI analyses were conducted using BEAST 1.8.2 (Drummond et al., 2012), setting a Yule process tree prior and an uncorrelated lognormal relaxed clock. Three replicate analyses were run for 10^8 million generations each, sampling every 10000th tree, and were combined using LogCombiner 1.8.2 (Drummond et al., 2012) with a burn-in of 25%, after checking the stationarity for effective sampling size and unimodal posterior distribution using Tracer v.1.6 (Rambaut et al., 2014). Maximum clade credibility trees were obtained using TreeAnnotator 1.8.2 (Drummond et al., 2012). ML and BI analyses were run on the CIPRES server (Miller et al., 2010). The nodal supports of all phylogenetic reconstructions were mapped onto the BI tree. We considered the node support as maximal when bootstrap values for MP (MP BS) and ML (ML BS) analyses were = 100 and Bayesian posterior probabilities (BPP) were = 1, high when BS ≥ 75 and BPP ≥ 0.9 , and low when BS < 75 and BPP < 0.9 . Nodes with low support for all the analyses were collapsed.

Genetic distances within and between Zancleidae species were calculated with MEGA X (Kumar et al., 2018) as % uncorrected *p*-distances with 1000 nonparametric bootstrap replicates and were presented as density plots of intra- and interspecific genetic distances for each Zancleidae clade using the ggplot2 package (Wickham, 2009) in the R environment (R Core Team, 2020).

Phylogenetic comparative methods

The evolution of selected discrete morphological and ecological traits was assessed performing ancestral state reconstructions on the Capitata phylogeny using stochastic mapping (Huelsenbeck et al., 2003). The studied characters (Table S3) were: (i) symbiotic lifestyle (presence, absence), (ii) host (generalist, bryozoan, scleractinian coral, octocoral, sponge, mollusc), (iii) perisarc (presence, absence), (iv) polymorphism, intended as colonies with gastrozooids and dactylozooids (presence, absence), (v) heteronemes, intended as cnidocytes of the eurytele and mastigophore type (presence, absence), (vi) colony type (stolonial, erect, solitary, pelagic), (vii) reproductive stage (medusa, medusoid, sporosac) and (viii) habitat (tropical, nontropical, both). Hydrozoan species were considered as “symbiotic” when living as epibionts or partial epibionts of other organisms, and “generalist” when living associated to more than one of the host groups listed above or living on abiotic substrates. Probable realizations of the evolution of the characters were mapped onto the Capitata phylogeny using the “make.simmmap” function in the phytools package (Revell, 2012) in R (R Core Team, 2020). Because the character states were unknown for some of the tips, the input character state vector was converted into a matrix of prior probabilities for tip states, and equal probabilities for each state were assigned for these unknown tip states (e.g. it is unknown whether the polyp stage of *Zanclea mayeri* Schuchert & Collins, 2021 lives in symbiosis with other organisms and therefore the tip states “presence” and “absence” were assigned equal probabilities of 0.5 for the character “symbiotic lifestyle”). Reconstructions were run under the “equal rates” (ER) and “all rates different” (ARD) models, comparing the fit of the models with a likelihood ratio test using the function “pchisq” and resulting in the selection of the ARD model for all characters except habitat (ER model). For each reconstruction, 10000 stochastic mapping replicates were run and the results were summarized with pie charts representing the posterior probability of each internal node being in each state.

The presence of evolutionary correlation between some of the characters was also tested using the Pagel’s method (Pagel, 1994), which, by fitting different models to the data (e.g. two traits evolve independently vs. the evolution of two characters is correlated) and performing a likelihood ratio test, assesses whether the difference between models is significant. The tested relationships were between the character “symbiotic lifestyle” and all other characters but “host”, to assess whether the evolution of symbiosis influenced the evolution of morphological traits and to test whether living in tropical environments favoured the shift to a symbiotic lifestyle. Tests were carried out using the “fitPagel” function in the phytools package (Revell, 2012) after re-coding character states to binary (Table S2) and after pruning the tree from species with unknown states. For each test, four models of coevolution between characters *x* and *y* were fitted to data (independent evolution; the evolution of *x* depends on the evolution of *y*; the evolution of *y* depends on the evolution of *x*; *x* and *y* evolve interdependently) and results were compared using AIC weights (AICw) and performing a likelihood ratio test between each model assuming coevolution and the model assuming independent evolution.

Alignments, raw phylogenetic trees, and R scripts and files used for the phylogenetic comparative methods are available at the following link: <https://figshare.com/s/f700a8fe9e61b1bde4e3>.

Results

Molecular phylogenetics

Sampling activities resulted in the collection of 60 Capitata species, with most species belonging to the

superfamily Zancleida (Fig. 1; Table S1). All specimens were identified to the lowest taxonomic level possible, but in some cases a species identification was not possible, owing to the lack of suitable morphological diagnostic characters and incomplete knowledge of the life cycle (i.e. only the medusa or polyp stage was available). These species are dealt with in the "Taxonomic account" section.

The assembled genetic dataset included 223 specimens, 115 species, 35 genera and 14 families of Capitata hydrozoans, representing the most complete dataset employed so far for phylogenetic analyses of the suborder. The MP, BI and ML reconstructions were broadly concordant and the nodal supports of each analysis were mapped onto the BI tree (Fig. 2). The Capitata were fully supported and divided into the two clades Zancleida and Corynida, both showing high support in almost all analyses, with the only exception being the Zancleida, which was not supported by the MP analysis. A clade composed of the families Pennariidae McCrady, 1859, Hydrocorynidae Rees, 1957, Halimedusidae Arai & Brinckmann-Voss, 1980, and Moerisiidae Poche, 1914 was a sister to all other Zancleida taxa. Within this clade, Pennariidae and Hydrocorynidae were sister groups, and so were Halimedusidae and Moerisiidae. Notably, *Tiaricodon orientalis* Yamamoto & Toshino, 2021 had a higher affinity with the Moerisiidae than with the Halimedusidae, to which it is currently ascribed, but further sampling is needed to clarify this issue. Zancleopsidae Bouillon, 1978 and Sphaerocorynidae Prévot, 1959 were highly supported and, together, placed as a sister group to the remaining Zancleida, followed by Cladocorynidae Allman, 1872 and Porpitidae Goldfuss, 1818. The families Milleporidae Fleming, 1828 and Solanderiidae Marshall, 1892 formed two fully supported, reciprocally monophyletic clades, even if the support of this sister-group relationship was low. Finally, Zancleida resulted to be polyphyletic in all analyses and, overall, cryptic species were common in different Zancleida groups, namely in *Apatizanclea divergens* (Boero, Bouillon & Gravili, 2000), coral-associated *Zanclea* spp., *Solanderia secunda* (Inaba, 1892), *Pteroclava krempfi* (Billard, 1919) and *Pennaria disticha* Goldfuss, 1820.

Regarding the Zancleidae, several *Zanclea* species formed a highly supported group corresponding to the "true" family Zancleidae and the genus *Zanclea* (Figs 2 and 3a), including the type species *Zanclea costata* Gegenbaur, 1857. The other included species were *Z. tipis* Puce, Cerrano, Boyer, Ferretti & Bavestrello, 2002, *Z. giancarlo* Boero, Bouillon & Gravili, 2000,

Z. sessilis (Gosse, 1853), *Z. implexa* (Alder, 1856), coral-associated *Zanclea* species, including *Z. sango* Hirose & Hirose, 2011 and *Z. gallii* Montano, Maggioni & Puce, 2015, *Zanclea* cf. *migottoi*, five unidentified species from the Mediterranean, Florida, China, Caribbean and Maldives, and *Zanclea pirainoid* (Boero, Bouillon & Gravili, 2000) **comb.n.**, previously ascribed to the genus *Halocoryne* Hadzi, 1917. Sequences of *Z. migottoi* Galea, 2008 from GenBank, and three *Zanclea* specimens from the Caribbean and the Maldives formed a fully supported group, with a moderate intragroup genetic distance of 1.5% (Table S4) and were named *Z. cf. migottoi*, pending further sampling to clarify if they belong to the same species or are a species complex (see "Taxonomic account" section). Sequences from China were downloaded from GenBank but no associated data were available. The other undetermined species could not be identified to the species level as a consequence of a lack of information about the polyp or medusa stage and are described in the "Taxonomic account" section. The intra- and interspecific genetic distances of *Zanclea* species did not overlap, showing nevertheless a very narrow gap (Fig. 3d; Table S4). The other species ascribed to the genus *Zanclea* formed three divergent groups. A first was composed of *Zanclea prolifera* Uchida and Sugiura, 1976 alone, showing a sister-group relationship with the Asyncorynidae Kramp, 1949 (Fig. 2), even if with low support. For a second clade, including the species *Zanclea divergens*, *Zanclea mayeri*, *Zanclea exposita* Puce, Cerrano, Boyer, Ferretti & Bavestrello, 2002, *Zanclea* sp. 1 and *Zanclea* sp. 2 (sensu Maggioni et al., 2018), the new genus *Apatizanclea* **gen.n.** is erected, resulting in the new combinations *Apatizanclea divergens*, *Apatizanclea mayeri*, *Apatizanclea exposita*, *Apatizanclea* sp. 1 and *Apatizanclea* sp. 2 (Figs 2 and 3b). This clade showed uncertain intragroup phylogenetic relationships, but all species were well-defined, also according to genetic distance analysis (Fig. 3d; Table S4), with a clear separation between intra- and interspecific distances. A third, fully supported group was composed of *Halocoryne protecta* (Hastings, 1932) **comb.n.**, *Halocoryne eilatensis* (Pica, Bastari & Puce, 2017) **comb.n.** and *Halocoryne epizoica* Hadzi, 1917 (Fig. 3c), with the first two, previously ascribed to the genus *Zanclea*, being sister species (Fig. 3c) and sharing almost identical morphologies (Pica et al., 2017; Maggioni et al., 2020b). Intra- and interspecific genetic distances showed some overlapping values in this group, due to the high intraspecific divergence of *H. eilatensis* (Fig. 3d; Table S4).

Fig. 2. Bayesian phylogenetic hypothesis of the Capitata, obtained from the concatenated dataset and including one specimen per species. Numbers at nodes represent BPP, ML BS, and MP BS, respectively. Asterisks denote maximal support for all analyses, whereas dashes (–) indicate nodes that were not supported in the corresponding analyses. The scale bar indicates the mean number of nucleotide substitutions per site.

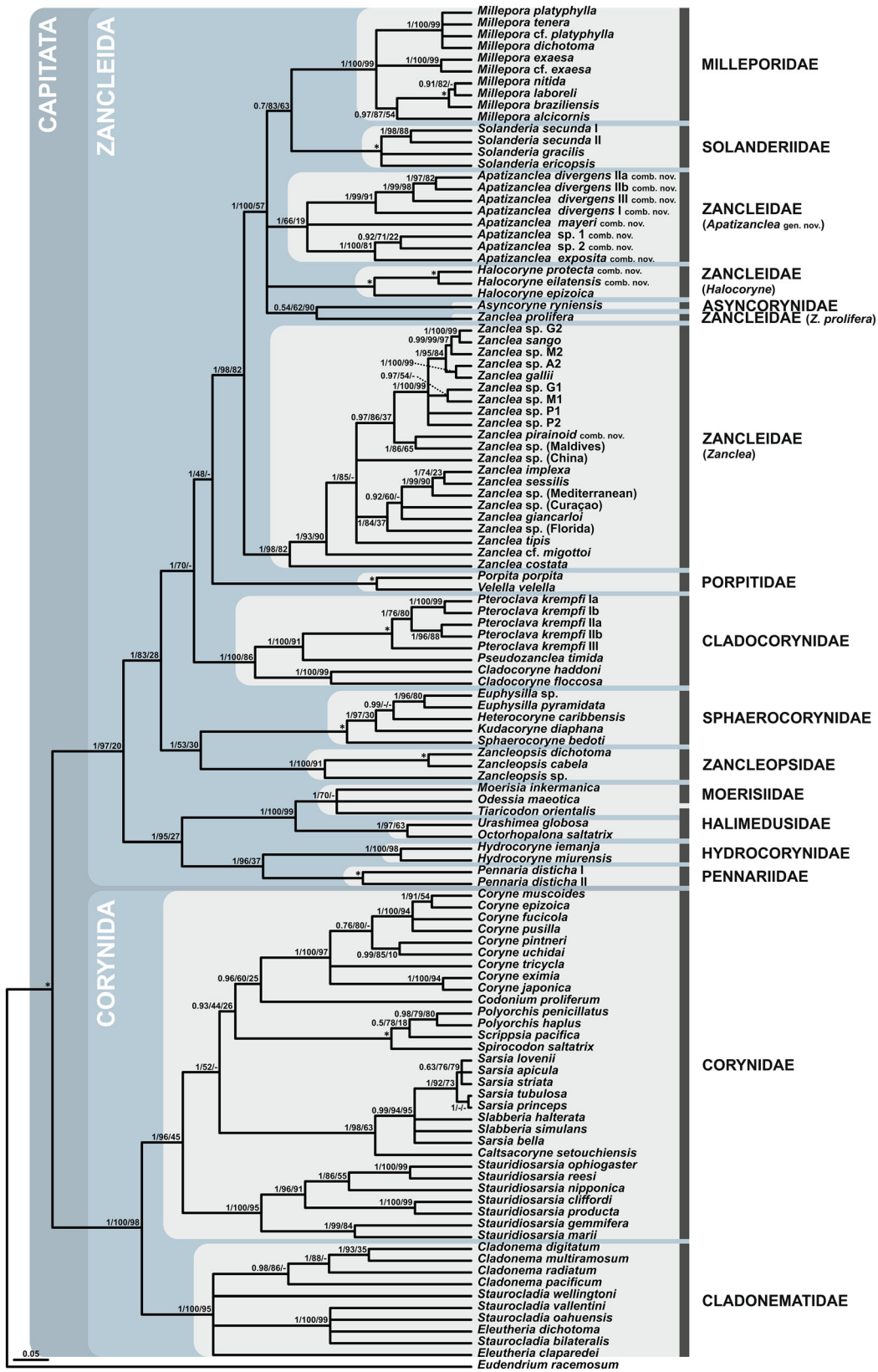

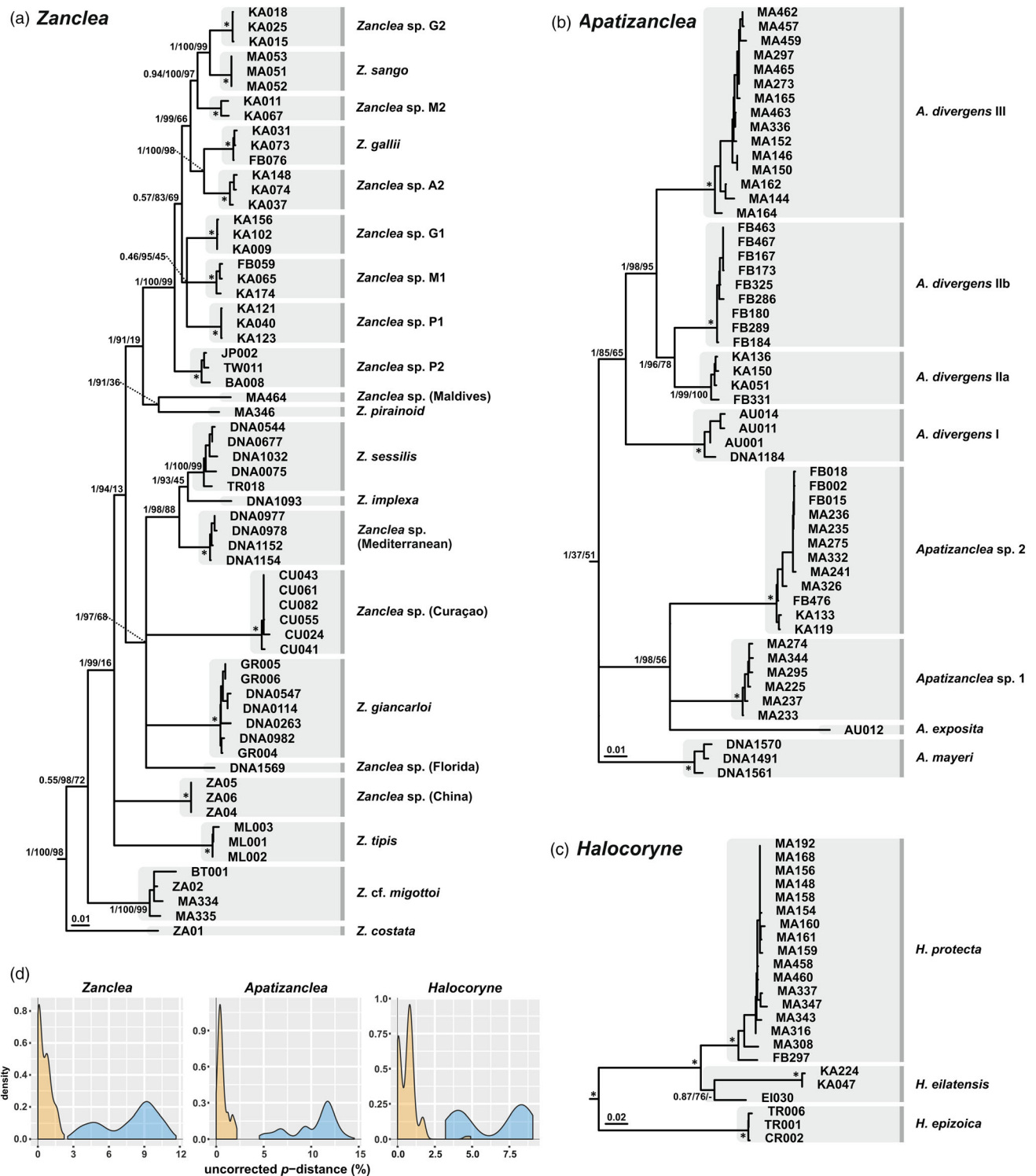

Fig. 3. Phylogenetic hypotheses of (a) *Zanclea*, (b) *Apatizancelea* and (c) *Halocoryne*. Numbers at nodes represent BPP, ML BS, and MP BS, respectively. Asterisks denote maximal support for all analyses, whereas dashes (–) indicate nodes that were not supported in the corresponding analyses. Scale bars indicate the mean number of nucleotide substitutions per site. (d) Density plots of the genetic distances (uncorrected *p*-distances in %) of the three clades shown in the phylogenetic trees, with intraspecific distances in yellow and interspecific distances in light blue.

The superfamily Corynida encompasses the families Corynidae and Cladonematidae, which both were highly supported in the phylogenetic hypotheses presented here (Fig. 2). In the family Corynidae, the group composed of *Sarsia* Lesson, 1843 and *Slabberia* Forbes, 1846 formed a well-supported monophyletic group, but the internal relationships were not completely resolved. Despite most *Sarsia* species forming a cohesive clade, the position of *Sarsia bella* Brinckmann-Voss, 2000 was unclear, as well as the validity of the genus *Slabberia*. A more confusing situation occurred within Cladonematidae, where, despite the genus *Cladonema* Dujardin, 1843 being monophyletic and well-supported, the relationships among *Staurocladia* Hartlaub, 1917 and *Eleutheria* Quatrefages, 1842 were unclear (Fig. 2) and insufficiently resolved to understand the validity of the two genera.

Taxonomic account

In this section the descriptions of undetermined or dubious *Zanclaea* species are provided, together with diagnoses of the genera *Zanclaea*, *Halocoryne* and *Apatizanclaea*. The family Zancleidae was not split in different families because phylogenetic relationships were not fully resolved, especially in relation to the families Asyncorynidae, Millerporidae and Solanderiidae. Owing to the need for genetic data to solve the phylogenetic position of all zancleid species, generic diagnoses are based solely on the species included in the molecular analyses, and affinities with species not included are discussed in the "Remarks" sections.

Hydrozoa Owen, 1843

Capitata Kuhn, 1913

Zancleidae Russel, 1953

Zanclaea Gegenbaur, 1856

Diagnosis: Polyps colonial, stolonial with creeping hydrorhiza, with or without perisarc, frequently associated with other organisms including bryozoans, scleractinian corals, molluscs and algae. Polyps monomorphic or polymorphic, including gastrozooids and dactylozooids. Gastrozooids cylindrical or claviform with oral and aboral capitata tentacles or without tentacles. Dactylozooids elongated and contractile, with or without capitata tentacles. Cnidome composed of stenoteles generally of two size classes, with or without macrobasic euryteles or mastigophores. Medusae with bell-shaped umbrella, four radial canals, and four exumbrellar perradial cnidocyst patches or lines with stenoteles. Manubrium bearing gonads inter-radially, ending with a mouth simple and circular. Four bulbs with no ocelli, forming two or four tentacles equipped with cnidophores containing bean-shaped macrobasic euryteles.

Species currently included in the genus: *Z. costata* (type species), *Z. migottoi*, *Z. giancarloii*, *Z. sessilis*,

Z. implexa, *Z. pirainoid* **comb.n.**, *Z. tipis*, *Z. gallii*, *Z. sango*, other undetermined species associated with scleractinian corals and bryozoans or known from the medusa stage only.

Remarks: Zancleidae is a species-rich family composed of taxa in many cases hardly distinguishable or with partially unknown life cycles, making it difficult to assess their systematic affinities without genetic data. The many species described based on the polyp or medusa alone and without DNA data contributed to fuelling the taxonomic confusion of this family. For this reason, it is challenging to assess whether the many *Zanclaea* species not included in the phylogenetic analyses belong to this genus. The family has been previously subdivided into the three genera *Zanclaea*, *Halocoryne* and *Zanclella* Boero & Hewitt, 1992, even if the validity of the latter two has been questioned, owing to the overlap of the morphological characters used in their diagnoses (Schuchert, 1996, 2010). On the one hand, the type species of *Zanclaea*, *Z. costata*, belongs to a well-supported clade that we defined as the "true" Zancleidae and *Zanclaea*, together with many other species. On the other hand, the type species of *Halocoryne*, *H. epizoica*, is divergent from this group and the genus should therefore not be considered as part of the Zancleidae anymore. Further sampling is needed to address this issue. Nevertheless, a species previously ascribed to *Halocoryne* has been demonstrated to belong to the genus *Zanclaea*, and, likewise, species previously ascribed to *Zanclaea* were moved to the genus *Halocoryne*, hampering clear morphological diagnoses for both genera. The situation remains even more uncertain for *Zanclella*, with *Zanclella diabolica* Boero, Bouillon & Gravili, 2000 sharing strong similarities with *Apatizanclaea* species. However, no molecular data are available for the type species *Zanclella bryozoophila* Boero & Hewitt, 1992. For this reason, for the moment being, we consider Zancleidae as a polyphyletic family.

Zanclaea cf. migottoi. Figure 4

Material examined. BT001: Panama, Bocas del Toro (9.3509° N, 82.2548° W), August 2015, attached to a floating *Sargassum* sp.—MA0117152 (DNA code: MA334): Maldives, Faafu Atoll, Adangau Island (3.1429° N, 73.0121° E), 18.II.2017, 10 m deep, on *Parasmittina egyptiaca* (Waters, 1909).—MA0117155 (DNA code: MA335): Maldives, Faafu Atoll, Adangau Island (3.1429° N, 73.0121° E), 18.II.2017, 10 m deep, on a coralline alga.

Description. Colony stolonial, growing on different substrates including *Sargassum* algae (Fig. 4a), bryozoans (Fig. 4b) and coralline algae (Fig. 4c). Hydrorhiza with a thick perisarc, reticular, crawling on the substrate, and often with epiphytes (Fig. 4d–f). Colonies monomorphic, gastrozooids tubular to clavate, up

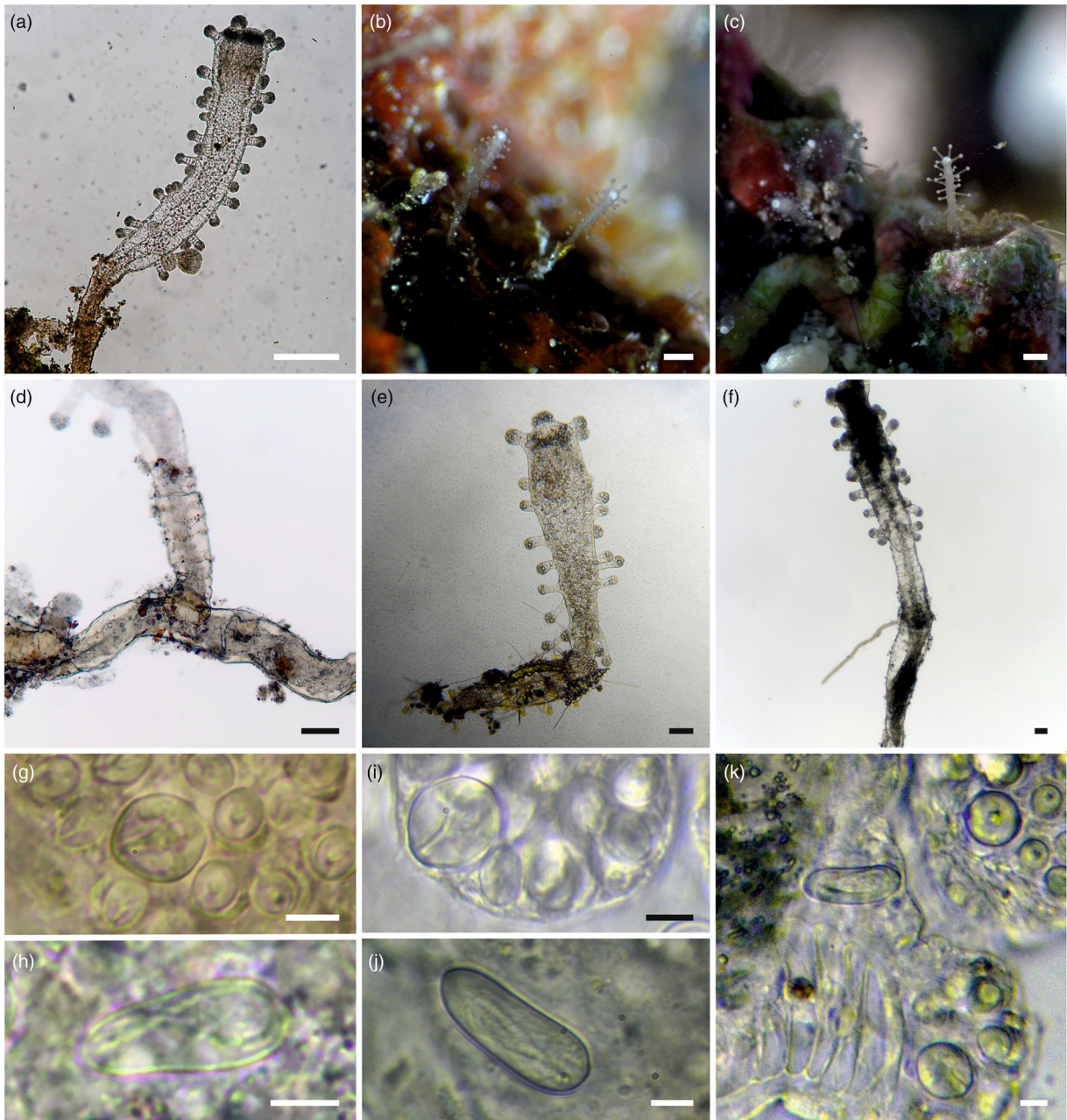

Fig. 4. *Zanlea cf. migottoi* from (a, d, g, h) Panama associated with *Sargassum* sp. (sample BT001), (b, e, i, j) Maldives associated with a bryozoan (sample MA0117152) and (c, f, k) Maldives associated with a red alga (sample MA0117155). (a–c) Polyps of living colonies on various substrates. (d) Detail of a corrugated pedicel. (e, f) Polyps showing moderately long pedicels. (g) Stenoteles and (h) eurytele of BT001. (i) Stenoteles and (j) eurytele of MA0117152. (k) Stenoteles and eurytele of MA0117155. Scale bars: (a–c) 0.2 mm, (d–f) 50 μ m, (g–k) 5 μ m.

to 2 mm long, with a pedicel covered by perisarc (Fig. 4a,d–f), slightly corrugated in sample BT001 (Fig. 4d); a distal and circular mouth surrounded by 4–6 oral capitulate tentacles, and with up to 30 aboral capitulate tentacles scattered over $\frac{2}{3}$ or $\frac{3}{4}$ of the polyp column (Fig. 4a,e,f). Capitula up to 45 μ m in diameter. Living polyps transparent with a whitish mouth (Fig. 4b,c). Medusa buds observed in sample BT001

(Fig. 4a) and MA0117155, at the base of gastrozooids. Medusae not observed. Cnidome composed of stenoteles of two size classes (Fig. 4g,i,k) abundant in capitula, and macrobasic apotrichous euryteles (Fig. 4h,j,k) in the hypostome, distributed in the hydranth and in some cases concentrated at the base of tentacles, and in the hydrorhiza. In the Caribbean sample euryteles are rare and found only in the hydrorhiza. Large

stenoteles are $10\text{--}13 \times 9\text{--}10 \mu\text{m}$ in sample MA0117152, $8\text{--}11 \times 9\text{--}10 \mu\text{m}$ in sample MA0117155 and $9\text{--}10 \times 7\text{--}9 \mu\text{m}$ in sample BT001. Small stenoteles are $6\text{--}7 \times 4\text{--}5 \mu\text{m}$ in sample MA0117152, $5\text{--}6 \times 3\text{--}5 \mu\text{m}$ in sample MA0117155 and $5\text{--}6 \times 4\text{--}5 \mu\text{m}$ in sample BT001. Euryteles are $21\text{--}22 \times 8\text{--}9 \mu\text{m}$ in sample MA0117152, $21\text{--}22 \times 8\text{--}9 \mu\text{m}$ in sample MA0117152 and $16 \times 9 \mu\text{m}$ in sample BT001.

Distribution. Samples analysed here came from Caribbean Panama and from Faafu Atoll, Central Maldives. Records of *Z. migottoi* are from Guadeloupe (Galea, 2008), Yucatán, Mexico (Mendoza-Becerril et al., 2018), and Sergipe, Brasil (Castro Mendonça et al., 2022).

Remarks. *Zanclaea migottoi* was described by Galea (2008) to accommodate *Zanclaea* polyps previously attributed to *Z. cf. alba* and *Z. costata* (Migotto, 1996; Vervoort, 2006) but differing from these two species by the cnidome composition. Our Caribbean specimen comes very close to *Z. alba* (Meyen, 1834) in general morphology and in its association with the alga *Sargassum* sp. However, the presence of euryteles in the hydrorhiza, even if rare, points against its assignment to *Z. alba* and makes it more similar to *Z. migottoi*. Indeed, euryteles were never found in *Z. alba* (Calder, 1988; Galea, 2008) and *Z. migottoi* shows euryteles of a size comparable to our Caribbean material, even if in the present material euryteles were not found at the base of tentacles, as reported in the *Z. migottoi* description (Galea, 2008). Maldivian specimens showed a similar morphology, which also is similar to other monomorphic *Zanclaea* species with euryteles, and were associated with other substrates, namely a red alga, similar to the colony described in Migotto (1996), and a bryozoan. Genetically, these specimens were closely related to our Caribbean material and to a sequence obtained from GenBank (Accession number: MF538731) formerly identified as *Z. migottoi* (Mendoza-Becerril et al., 2018). Recent re-analysis of this latter specimen revealed the absence of euryteles in the polyp (Mendoza-Becerril, pers. comm.), fitting therefore the scope of *Z. alba*. Given the presence of euryteles in our specimens, we provisionally identified them as *Z. cf. migottoi*, but it might be possible that *Z. migottoi* and *Z. alba* are the same species, being the presence of euryteles variable and not diagnostic for this species. A focused morpho-molecular assessment is needed to disentangle this issue. Whatever the species identity of this lineage, it shows a wide distribution, spanning the Atlantic and Indian oceans, and is generalist in terms of substrate on which the polyps grow.

Zanclaea sp. (Maldives). Figure 5

Material examined. MA0318071 (DNA code: MA464): Maldives, Faafu Atoll, Adangau Island (3.1429°N , 73.0121°E), 19.III.2018, 25 m deep.

Description. Colony stolonial, growing in association with the cheilostome bryozoan *Plesioleidochasma laterale* (Harmer, 1957) (Fig. 5a–c). Hydrorhiza with a thin perisarc, reticular, crawling on (and possibly under) the host surface. Colonies monomorphic, gastrozooids tubular, up to 1 mm long, with a distal and circular mouth, surrounded by 5 oral capitate tentacles, and with up to 25 aboral capitate tentacles scattered over all the length of the polyp column (Fig. 5a–e), with 2–4 short tentacles often found at the base of the polyp (Fig. 5f). Capitula larger in oral tentacles (up to $50 \mu\text{m}$ in diameter) and smaller in aboral tentacles (up to $40 \mu\text{m}$ in diameter) (Fig. 5e). Living polyps transparent with a whitish mouth (Fig. 5a–d). Medusa buds originating in the proximal portion of the gastrozooid. Medusa not observed. Cnidome composed of stenoteles of two size classes (Fig. 5g) and macrobasic apotrichous euryteles (Fig. 5h,i). Large ($9\text{--}12 \times 8\text{--}10 \mu\text{m}$) and small stenoteles ($5\text{--}6 \times 4\text{--}5 \mu\text{m}$) abundant in capitula and hydrorhiza, euryteles ($21\text{--}24 \times 8\text{--}12 \mu\text{m}$) present around the hypostome and scattered in the hydranth.

Distribution. Known only from Faafu Atoll, Central Maldives.

Remarks. The only analysed colony can hardly be distinguished from other monomorphic *Zanclaea* species with macrobasic apotrichous euryteles. Among these species, some show different host preferences, such as *Z. fanella* Boero, Bouillon & Gravili, 2000 growing on mollusc shells in the Western Pacific and coral-associated *Zanclaea*. Other similar species are *Z. giancarloi*, *Z. implexa* and *Z. migottoi*, which nevertheless clearly differ from a genetic point of view and are generalists in the substrate on which they settle. Several *Zanclaea* species were described from the Indo-Pacific based on their medusa stage only (Maggioni et al., 2018) and, given also the unknown medusa stage for the Maldivian specimen, we were unable to assign it to any known or new species.

Zanclaea sp. (Curaçao). Figure 6

Material examined. CU024: Curaçao, St. Michiel's Bay (12.1481°N , 69.0003°W), 10.VI.2017, 22 m deep.—CU041: Curaçao, Playa Marie Pampoen (12.0901°N , 68.9052°W), 12.VI.2017, 27 m deep.—CU043: Curaçao, Substation (12.0844°N , 68.8983°W), 12.VI.2017, 22 m deep.—CU055: Curaçao, Caracas Bay, Tugboat Beach, (12.0681°N , 68.8622°W), 13.VI.2017, 15 m deep.—CU061: Curaçao, Playa Kalki (12.3750°N , 69.1578°W), 14.VI.2017, 15 m deep.—CU082: Curaçao: Coral Estate (12.1958°N , 69.0795°W), 17.VI.2017, 30 m deep.

Description. Colony stolonial, exclusively growing in association with the cheilostome bryozoan *Trematoecia aviculifera* (Canu & Bassler, 1923) (Fig. 6a–f).

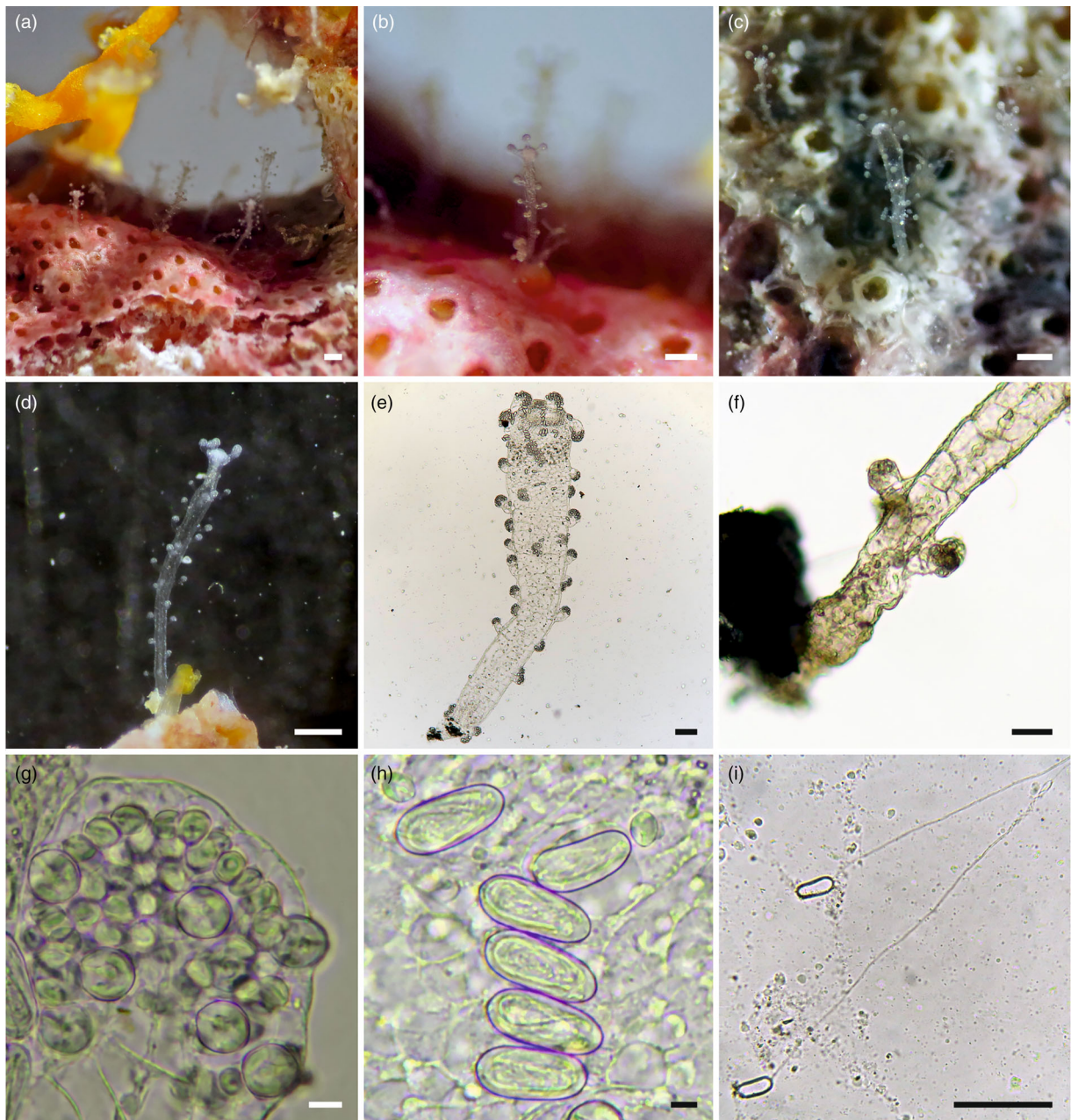

Fig. 5. *Zanclea* sp. from Maldives associated with *Plesioleidochasma laterale*. (a–d) Polyps of living colonies on the host bryozoan. (e) Gastrozoid and (f) detail of two tentacles at the base of the polyp. (g) Capitulum with small and large size stenotele. (h) Undischarged and (i) discharged macrobasic apotrichous eurytele capsules. Scale bars: (a–d) 0.2 mm, (e, f) 50 μm , (g–i) 5 μm .

Hydrorhiza devoid of perisarc, reticular, crawling under the host skeleton or among the grooves of the autozooids and projecting out for some of its length. Colonies polymorphic, composed of gastrozooids (Fig. 6a–d) and dactylozooids (Fig. 6e,f). Gastrozooids tubular, ≤ 1 mm long, with a distal circular mouth, surrounded by 5 or 6 oral capitate tentacles, and with up to 40 aboral capitate tentacles scattered over all the length of the polyp column (Fig. 6g).

Capitula larger in oral tentacles (up to 60 μm in diameter) and smaller in aboral tentacles (up to 40 μm in diameter) (Fig. 6g). Dactylozooid thin and very extensible, up to 2.5 mm long, without a mouth, and with 4 distal capitate tentacles (capitula up to 90 μm in diameter) (Fig. 6h,i). Living gastrozooids transparent with a whitish mouth, dactylozooids transparent (Fig. 6a–d). Medusa buds originating directly from the hydrorhiza. Medusa not observed. Cnidome composed of

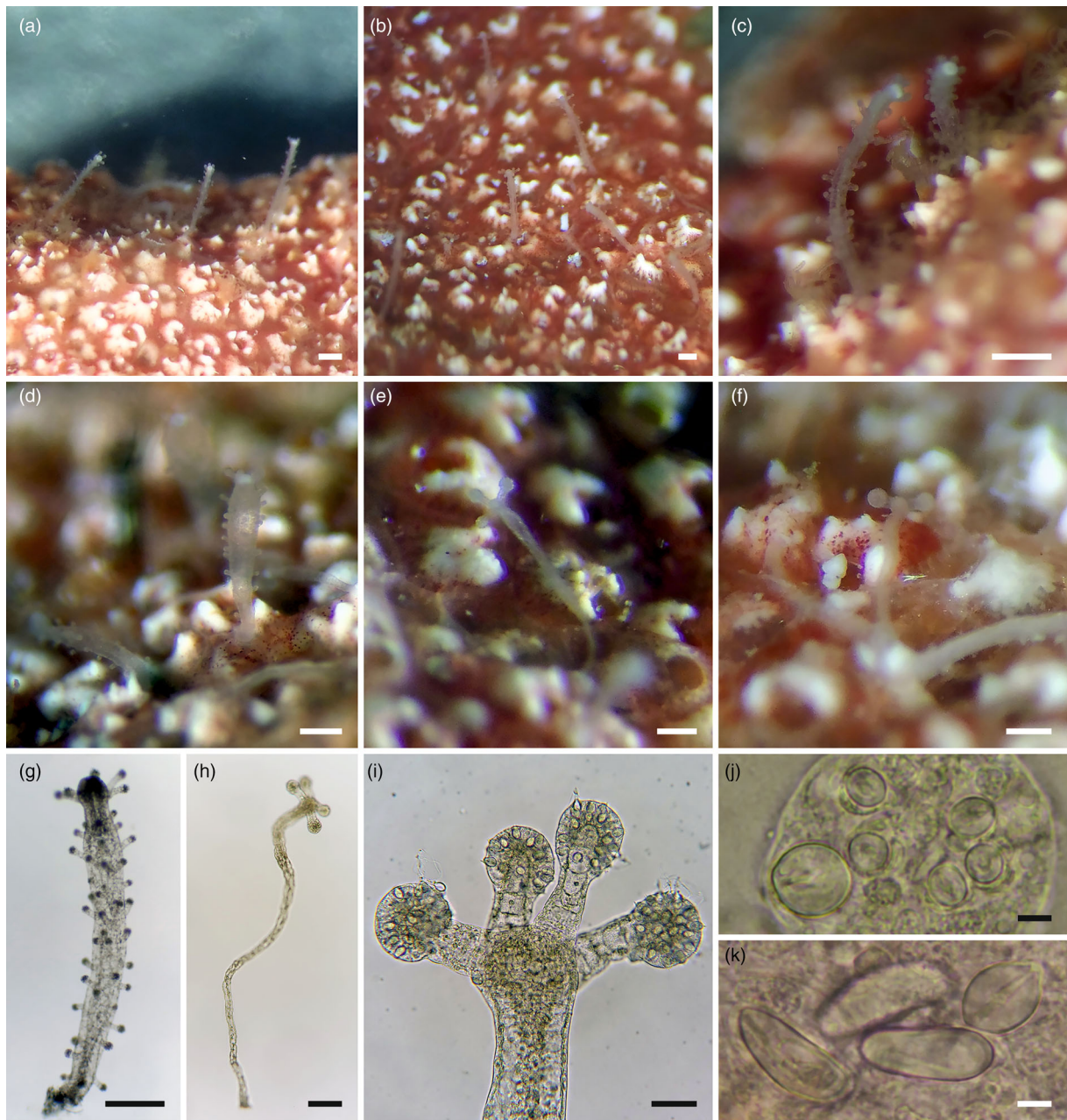

Fig. 6. *Zanclea* sp. from Curaçao associated with *Trematooecia aviculifera*. (a–d) Gastrozooids and (e, f) dactylozooids showing over the host bryozoan colony. (g) Gastrozooid and (h) dactylozooid, with (i) detail of the four dactylozooid tentacles. (j) Capitulum with small and large size stenoteles and (k) euryteles. Scale bars: (a–f) 0.2 mm, (g, h) 50 μ m, (i, j) 5 μ m.

stenoteles of two size classes (Fig. 6j) and macrobasal apotrichous euryteles (Fig. 6k). Large (10–14 \times 8–11 μ m) and small stenoteles (5–7 \times 4–5 μ m) abundant in capitula, euryteles (15–20 \times 7–9 μ m) in the hydro-rhiza, at the base of gastrozooids, and in the distal portion of the dactylozooids.

Distribution. Known only from Curaçao, Caribbean Sea.

Remarks. A few *Zanclea* species are reported to have tentaculated dactylozooids, namely *Z. sessilis* from the

Mediterranean and Atlantic, *Z. polymorpha* Schuchert, 1996 from New Zealand, *Z. bomala* Boero, Bouillon & Gravili, 2000 from California and *Z. hirohitoi* Boero, Bouillon & Gravili, 2000 from Papua New Guinea (Schuchert, 1996; Boero et al., 2000; Altuna, 2016). The specimens analysed herein differ genetically from *Z. sessilis* and also show some differences compared to the other species. *Zanclea bomala* lacks euryteles and *Z. hirohitoi* has tentaculozooids that are absent in the present specimens.

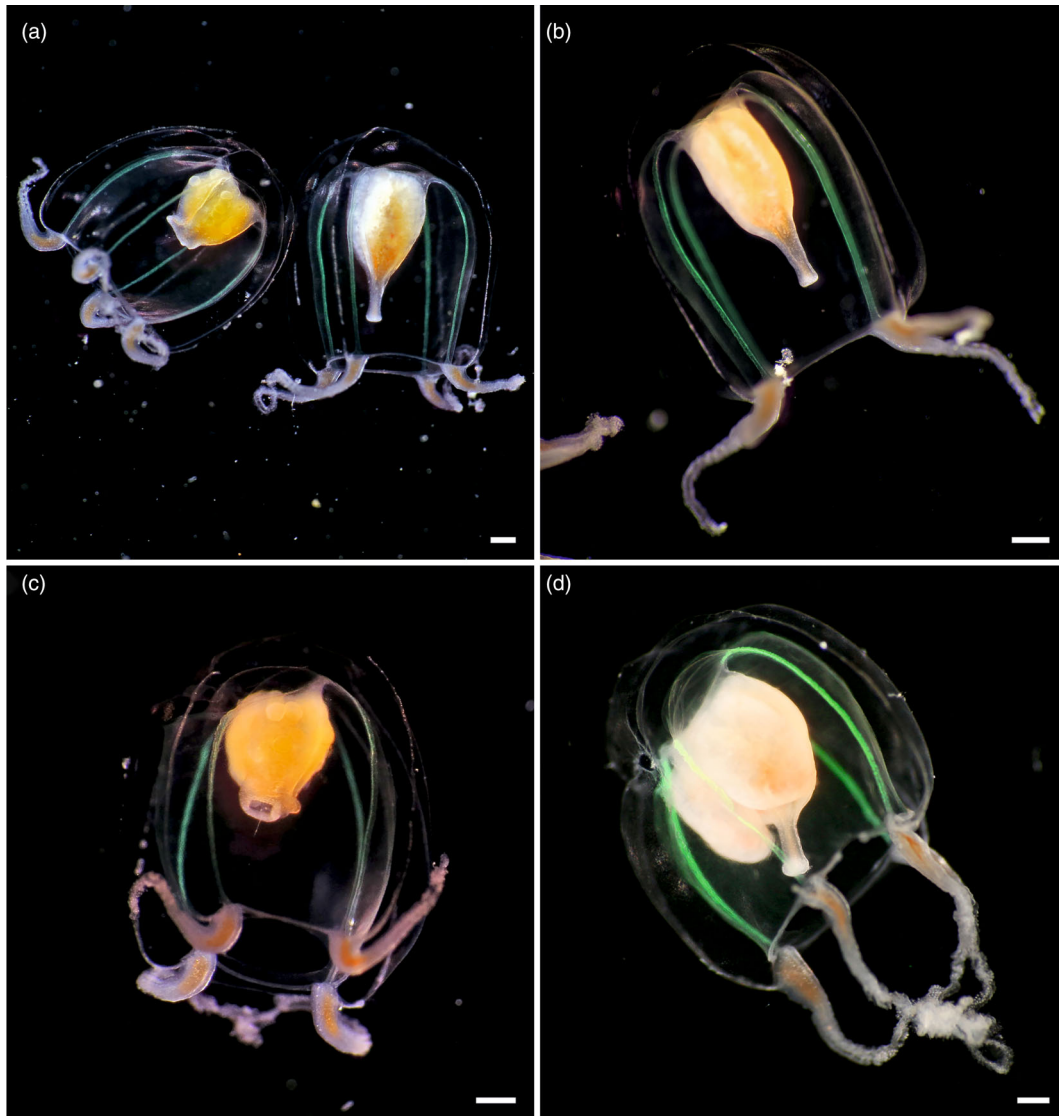

Fig. 7. *Zanclea* sp. medusa with four tentacles from western Mediterranean. (a) Female (left) and male (right) medusae and higher magnification of the same (b) male and (c) female specimens. (d) Another male individual. Scale bars: 0.5 mm.

Zanclea polymorpha is the most similar species, nevertheless showing a lower number of aboral tentacles and larger euyteles, and being associated with a different bryozoan species, namely *Rhynchozoon larreyi* (Audouin, 1826). A few *Zanclea*-like medusae, whose polyp stage is still unknown, have been reported from the Atlantic Ocean, such as *Apatizanclea mayeri* and *Zanclea* sp. from Florida (Schuchert and Collins, 2021)—but these two species clearly differ genetically from this species (Figs 2 and 3), *Z. sagittaria* (Haeckel, 1879) from Cuba (Haeckel, 1879), and *Z. medusopolypata* Boero, Bouillon & Gravili, 2000 from Venezuela and Brazil (Boero et al., 2000). However, no genetic data are available for the latter two species. Given the more or less distinct morphological differences, the genetic differences, and the disjunct

geographical distributions, we refer to our specimens as *Zanclea* sp. pending further sampling and analyses.

Zanclea sp. (Mediterranean). Figure 7

Material examined. Vfr14-01 (DNA code: DNA0977), male: France, Bay of Villefranche-sur-Mer (43.6856° N, 7.3178° E), 28.IV.2014, 0–70 m deep.—Vfr14-02 (DNA code: DNA0978), female: France, Bay of Villefranche-sur-Mer (43.6856° N, 7.3178° E), 28.IV.2014, 0–70 m deep.—Vfr16-11 (DNA code: DNA1152), male: France, Bay of Villefranche-sur-Mer (43.6856° N, 7.3178° E), 28.IV.2016, 0–20 m deep.—Vfr16-15 (DNA code: DNA1154), male: France, Bay of Villefranche-sur-Mer (43.6856° N, 7.3178° E), 29.IV.2016, 0–75 m deep. All specimens were collected with plankton net by PS.

Description. Mature medusa ~5 mm high and 4 mm wide, umbrella bell-shaped, apex slightly pointed. Exumbrella with 4 perradial nematocyst bands, extending from circular canal to apex. Manubrium large, extending for $\frac{3}{4}$ of subumbrellar cavity, with a larger upper part and a thinner, cylindrical mouth region. Upper part of manubrium cruciform in cross-section, with gonads separated perradially. Four radial canals ending in 4 tentaculated bulbs. Four thick tentacles, armed with spherical cnidophores. No ocelli present. Living medusae transparent, with orange manubrium and bulbs and radial canals showing green fluorescence. Cnidome composed of stenoteles and bean-shaped euryteles.

Distribution. Only known from the western Mediterranean Sea.

Remarks. Contrary to most zancleid species, all of the specimens belonging to this undetermined species have four tentacles. *Zanclaea costata* is known to produce two-tentacled newly liberated medusae that can develop two more tentacles at maturity (Schuchert, 2010), and its four-tentacled medusa is hardly distinguishable from our specimens. *Zanclaea costata* is currently thought to be a Mediterranean endemic and was described based on the four-tentacled medusa (Gegenbaur, 1857). In this species, all medusae observed after release from polyps and then cultivated showed two tentacles only (Cerrano et al., 1997; Schuchert, 2010), including the specimen described by Schuchert (2010) that we have analysed too. The latter showed a high genetic divergence from *Zanclaea* sp., with a 16S genetic distance of 7%. Two- and four-tentacled medusae were also found together in plankton samples, and it was hypothesized that the latter was a more developed stage of the same species (Browne, 1906). However, because no direct transition from two- to four-tentacle stages have been observed so far, the issue remains unsolved. *Zanclaea bomala* is another species with four tentacles in the adult medusa stage after being reared in laboratory (Boero et al., 2000). It shows nevertheless differences in the general morphology, especially in the perradial oval nematocyst pouches, that were absent in the present species. Finally, Altuna (2016) observed *Z. sessilis* medusae with a variable number of tentacles, spanning zero to three at liberation, and two to five at maturity. Adult *Z. sessilis* medusae also show slight differences with the present species, such as the median swellings of the radial canals, and the two species are genetically different, with a 16S genetic distance of 3.6%. Because the polyp stage of *Zanclaea* sp. is unknown, we cannot assign it to any known or new *Zanclaea* species.

Halocoryne Hadzi, 1917. **Diagnosis:** Polyps colonial, stolonal with creeping hydrorhiza, without perisarc, exclusively associated with bryozoans. Polyps

monomorphic or polymorphic, including gastrozooids and gono-dactylozooids. Gastrozooids cylindrical or claviform with oral and aboral capitate tentacles, or reduced, without tentacles. Gono-dactylozooids elongated, without tentacles. Cnidome composed of stenoteles of two size classes. Reproduction by medusae or medusoids. Medusae with bell-shaped umbrella, 4 radial canals, and 4 exumbrellar perradial cnidocyst patches with stenoteles. Manubrium bearing gonads interradially, ending with a mouth simple and circular. Four bulbs with no ocelli, originating 2 tentacles equipped with cnidophores containing bean-shaped macrobasic euryteles. Medusoids with bell-shaped umbrella, manubrium without mouth and with gonads in a single mass, 4 radial canals, 4 perradial bulbs without ocelli and without tentacles.

Species currently included in the genus: *H. epizoica* (type species), *H. eilatensis* **comb.n.**, *H. protecta* **comb.n.**

Remarks: The family Halocorynidae Picard, 1957 was erected by Picard (1957) to accommodate the species *H. epizoica*, later transferred to the family Zancleidae. The family Halocorynidae may need to be resurrected as a result of the clear divergence of *H. epizoica* from the Zancleidae, but owing to the phylogenetic uncertainties in our phylogenetic hypothesis we prefer to conservatively avoid this to prevent further taxonomic confusion. Three other species were described as belonging to the genus *Halocoryne*, namely *H. pirainoid*, *H. frasca* Boero, Bouillon & Gravili 2000 and *H. orientalis* (Browne, 1916). The first species was demonstrated in the present work to belong to the genus *Zanclaea*, despite having a polyp morphology similar to *H. epizoica* and *H. frasca*. Regarding the two other species, it is currently not possible to ascertain their belonging to the genus *Halocoryne* owing to lack of DNA data. On the one hand, the polyp stage of *H. frasca* has an overall morphology similar to *H. epizoica* but possesses macrobasic holotrichous euryteles, a feature absent in the type species and other *Zanclaea*-like species now ascribed to the genus. The presence of these euryteles makes *H. frasca* similar to species in the newly erected genus *Apatizanclea*, even if none of these species is polymorphic. Also *Z. costata* is known to possess this type of cnidocyst. On the other hand, *H. orientalis* is known only from the medusa stage and its systematic affinities remain even more doubtful. Finally, in our phylogeny reconstructions (Figs 2 and 3c), we found that the former *Z. eilatensis* and *Z. protecta* were closely related to *Halocoryne epizoica*, and the two species are thus here transferred to the genus *Halocoryne*.

Apatizanclea Maggioni **gen.n.** <http://zoobank.org/urn:lsid:zoobank.org:act:F80CFD68-B3DC-4A89-80F5-F53C254AEA26>

Diagnosis: Polyps colonial, stolonial with creeping hydrorhiza, without perisarc, exclusively associated with bryozoans. Polyps monomorphic. Gastrozooids cylindrical or claviform with oral and aboral capitate tentacles. Cnidome composed of stenoteles of two size classes and macrobasic holotrichous euryteles. Medusae with umbrella bell-shaped, 0 or 4 radial canals, and 0 or 4 exumbrellar perradial cnidocyst patches with stenoteles. Manubrium bearing gonads interradially, ending with a mouth simple and circular with or without oral arms. Two tentaculated bulbs with no ocelli, originating 2 tentacles equipped with cnidophores containing bean-shaped macrobasic euryteles. No atentaculate bulbs present.

Etymology: *Apatizancelea* derives from the combination of "ἀπατάω", meaning "to deceive, mislead" in ancient Greek, and *-zancelea*, referring to the fact that species in this genus can be easily confused with *Zancelea* species.

Species currently included in the genus: *A. divergens* **comb.n.** (type species, here designated), *A. mayeri* **comb.n.**, *A. exposita* **comb.n.**, and the two undetermined species *Apatizancelea* sp. 1 and *Apatizancelea* sp. 2.

Remarks: Our phylogeny reconstructions (Figs 2 and 3b) demonstrated that the lineage here described as *Apatizancelea* diverged from the genus *Zancelea*, forming a cohesive group and requiring the establishment of the new genus and new combinations. This genus is mostly based on genetic data, but similarities among the species are present in both the polyp and medusa stages, when known. Specifically, all known polyps possess macrobasic holotrichous euryteles, are devoid of perisarc, and are exclusively associated with bryozoans mostly belonging to *Celleporaria* species. The adult medusa is known only for *A. mayeri*, whereas newly released medusae are known for *A. divergens*, *Apatizancelea* sp. 1, and *Apatizancelea* sp. 2, but not for *A. exposita*. However, all of them share the presence of only two tentaculate bulbs and the absence of atentaculate bulbs. Adult medusae of *A. mayeri* and newly released medusae of *A. divergens* are typical *Zancelea*-like medusae. Newly released medusae of *Apatizancelea* sp. 1 and *Apatizancelea* sp. 2 show instead striking similarities with *Zancelella diabolica*, the latter also having polyps very similar to *Apatizancelea* sp. 1. As pointed out by Maggioni et al. (2018), *Apatizancelea* sp. 1 may actually correspond to *Z. diabolica*. Also *Zancelella glomboides* Boero, Bouillon & Gravili, 2000 possesses similar newly released medusae, and both young and adult medusae have only two bulbs, equipped with tentacles. The polyp stage of the latter species is reduced and polymorphic, contrarily to the known polyps of *Apatizancelea*. At the same time, it is associated with bryozoans, has no perisarc and shows macrobasic euryteles (even if it is still unknown

whether they are holotrichous), thus possibly matching the diagnosis for the *Apatizancelea* genus. *Zancelella* is a problematic genus, and its validity has been questioned previously (Schuchert, 1996, 2010). The type species is *Z. bryozoophila*, showing reduced, polymorphic polyps, no perisarc, macrobasic holotrichous euryteles and reproduction via medusoids. Unfortunately, no genetic data are available for this species, and therefore the validity of the genus *Zancelella* remains uncertain. Four other species have known medusae with two bulbs only, namely *Halocoryne frasca*, which also possesses polyps with macrobasic holotrichous euryteles, *Zancelea hirohitoi*, *Z. medusopolypata* and *Z. tipis*.

Range expansions and morphological modifications associated with the symbiotic lifestyle

In this work we report the expansion of geographical and host ranges for some species. In particular, the distribution of *Zancelea pirainoid* was extended westward, being reported for the first time in the Maldives, after its description from Papua New Guinea (Boero et al., 2000). *Apatizancelea exposita* was reported from Eastern Australia, after its description in North Sulawesi, Indonesia (Puce et al., 2002) and the distribution of *Halocoryne protecta* was extended to the Central Red Sea, being previously only known from the Indo-Pacific (Boero et al., 2000; Maggioni et al., 2020b). Finally, specimens identified as *Zancelea* cf. *migottoi* were reported from the Indian Ocean, whereas this species was previously known only from the Western Atlantic Ocean (Galea, 2008; Mendoza-Becerril et al., 2018; Mendonça et al., 2022). Regarding the extension of host ranges, *Z. pirainoid* is here reported associated with the bryozoan *Robertsonidra* sp., while the host bryozoan was not identified in the original description. Two *Zancelea* species appeared to be more generalist than previously thought, namely *Z. sessilis*, which was found growing on bare rock, red algae and bryozoans, and the *Zancelea* cf. *migottoi* group, found on *Sargassum* sp. in the Caribbean and on a red alga and the bryozoan *Parasmittina egyptiaca* in the Maldives. *Halocoryne eilatensis* was reported growing in association with the bryozoan *Adeonella* sp. in the Central Red Sea, whereas it was previously only known in association with *Parasmittina* species in the Northern Red Sea. Finally, *H. protecta* was found for the first time on the bryozoans *Parasmittina raigii* (Audouin, 1826), *P. egyptiaca*, *Calyptotheca* sp. and *Steginoporella* sp.

Morphological modifications of the skeleton of the hosts were observed in several symbiotic species, namely coral-associated *Zancelea* species (with the exception of the *Acropora*-associated ones), as already shown in Manca et al. (2019), and in Maggioni et al. (2020b, 2022a) and in bryozoan-associated

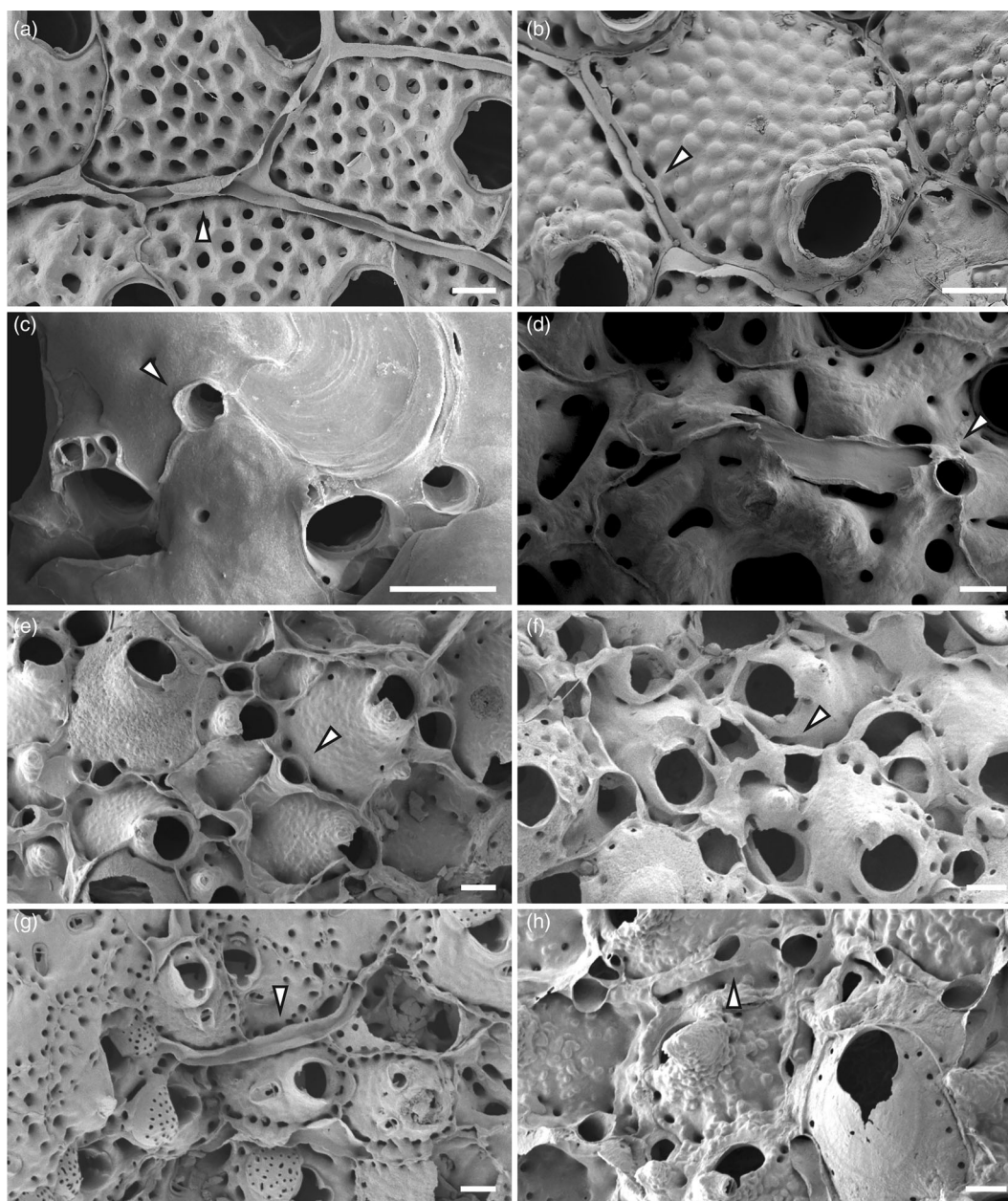

Fig. 8. Skeletal modifications in bryozoans hosting symbiotic hydrozoans. (a) *Schizobrachiella sanguinea* hosting *Halocoryne epizoica*. (b) *Robertsonidra* sp. hosting *Zanclea pirainoid*. (c) *Triphylozoon inornatum* hosting *Zanclea tipis*. (d) *Trematooecia aviculifera* hosting *Zanclea* sp. (Curacao). (e) *Celleporaria pigmentaria* hosting *Apatizancelea* sp. 1. (f) *Celleporaria* sp. hosting *Apatizancelea* sp. 2. (g) *Paramittina* cf. *spondylicola* hosting *Zanclea protecta*. (h) *Celleporaria* cf. *pigmentaria* hosting *Apatizancelea divergens* (lineage IIb). Arrowheads indicate examples of skeletal modification in each image. Scale bars: 100 µm.

species. Specifically, modifications of the bryozoan skeleton were observed in colonies hosting *H. epizoica*, *H. protecta*, *Z. pirainoid*, *Z. tipis*, *Zanclea* sp. (Curacao), the *A. divergens* species complex, *Apatizancelea* sp. 1 and *Apatizancelea* sp. 2 (Fig. 8). Skeletal modifications were mostly observed as a secondary calcification that covered or partially covered the hydrorhiza and base of the symbiotic hydroids (Fig. 8a,d–h). However, in *Z. tipis* only holes from

where hydrozoan polyps protruded were observed (Fig. 8c), and in *Z. pirainoid* modifications were represented by the formation of a smooth and open canal between the bryozoan zooids, where the hydrorhiza was accommodated (Fig. 8b).

In other symbiotic associations involving host sponges, octocorals, bivalves and algae, no obvious modifications either of the hydrozoans or the hosts were observed.

(a) **Symbiotic lifestyle**

- presence
- absence

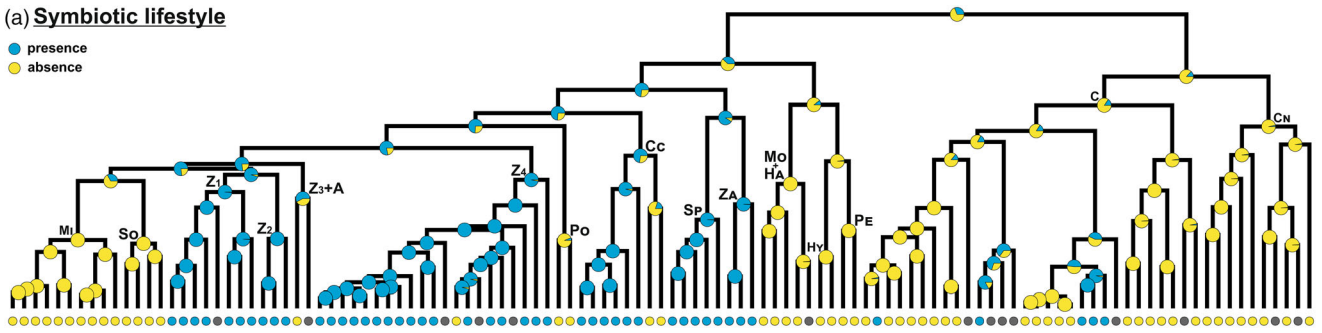

(b) **Host**

- generalist
- bryozoan
- scleractinian
- octocoral
- sponge
- bivalve

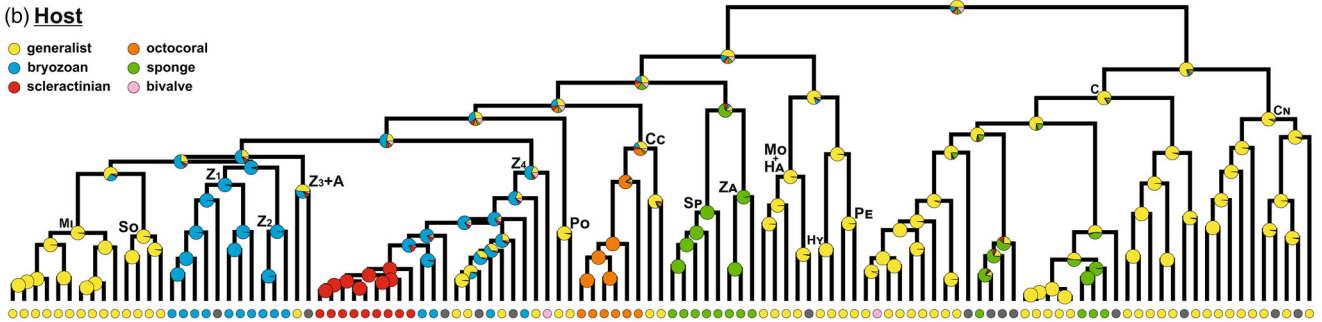

Millepora pachyphylla
Millepora tenera
Millepora cf. platyphylla
Millepora dichotoma
Millepora cf. exesa
Millepora nitida
Millepora brasiliensis
Millepora alcicornis
Solanidera secunda I
Solanidera gracilis
Solanidera ericopsis
Apatizanclea divergens II
Apatizanclea divergens III
Apatizanclea divergens I
Apatizanclea sp. 1
Apatizanclea sp. 2
Halocoryne protecia
Halocoryne elatensis
Halocoryne epizonica
Asyria prolifera
Zanclea sp. G2
Zanclea sp. M2
Zanclea sp. A2
Zanclea galii
Zanclea sp. M1
Zanclea sp. P1
Zanclea alpinoid
Zanclea sp. (Maldives)
Zanclea sp. (China)
Zanclea sessilis
Zanclea sp. (Mediterranean)
Zanclea sp. (Cape Verde)
Zanclea sp. (Florida)
Zanclea lipis
Zanclea costata
Porpita porpita
Pteroclavella krempflii
Pteroclavella krempflii b
Pteroclavella krempflii c
Pteroclavella krempflii III
Pseudozanclea limitata
Cladocoryne floccosa
Euphyllisia sp.
Euphyllisia pyramidata
Kudacoryne diaphana
Sphaerocoryne beototi
Zipiclopsis richoana
Zipiclopsis richoana b
Zancleopsis sp.
Zancleopsis sp.
Moerisia inermatica
Tricodonta orientalis
Urashimaea globosa
Ochromopala saitani
Pennaria disticha II
Hydrocoryne murenensis
Coryne muscoides
Coryne egizola
Coryne idiccola
Coryne uchida
Coryne pinteri
Coryne eximia
Coryne japonica
Cadonum proliferum
Polyorchis haplus
Scirpisia pacifica
Sarsia towenii
Sarsia apicula
Sarsia striata
Sarsia hallerata
Sarsia princeps
Sarsia balli
Callisacoryne setouchiensis
Stauridiosarsia ophiogaster
Stauridiosarsia nipponica
Stauridiosarsia cliffordi
Stauridiosarsia tenuifera
Cladonema digitatum
Cladonema radiatum
Cladonema pacificum
Staurocledia wallingfordii
Staurocledia oahuensis
Elautheria dichotoma
Elautheria setouchiensis
Elautheria caplaredei

(c) **Perisarc**

- presence
- absence

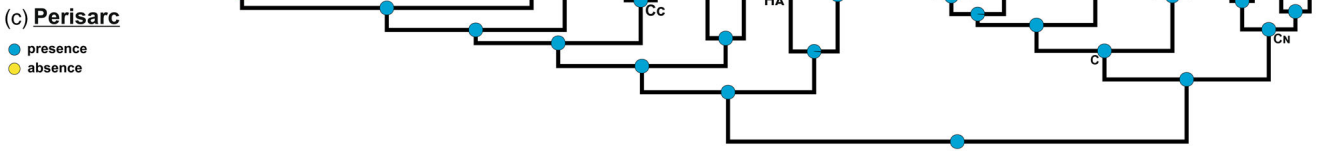

(d) **Polymorphism**

- presence
- absence

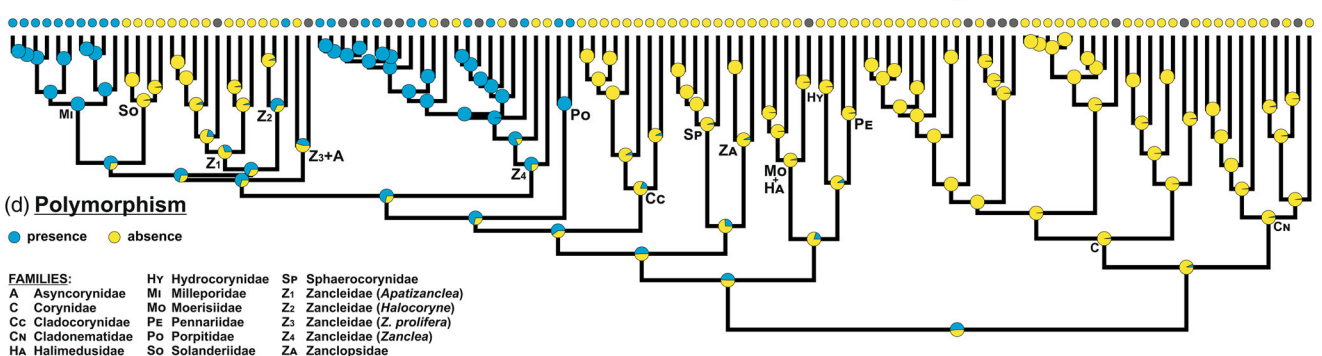

FAMILIES:
 A Asyncoryniidae Hy Hydrocoryniidae SP Sphaerocoryniidae
 Mi Milleporidae Z1 Zancleidae (*Apatizanclea*)
 C Coryniidae Mo Moerisiidae Z2 Zancleidae (*Halocoryne*)
 Cc Cladocoryniidae PE Pennariidae Z3 Zancleidae (*Z. prolifera*)
 CN Cladonematidae Po Porpitiidae Z4 Zancleidae (*Zanclea*)
 HA Halimedusidae So Solanderiidae ZA Zanclopsiidae

Fig. 9. Ancestral state reconstructions of the characters (a) symbiotic lifestyle, (b) host, (c) perisarc and (d) polymorphism. Pie charts represent the posterior probability of each node being in each state. Grey circles at tips represent unknown states.

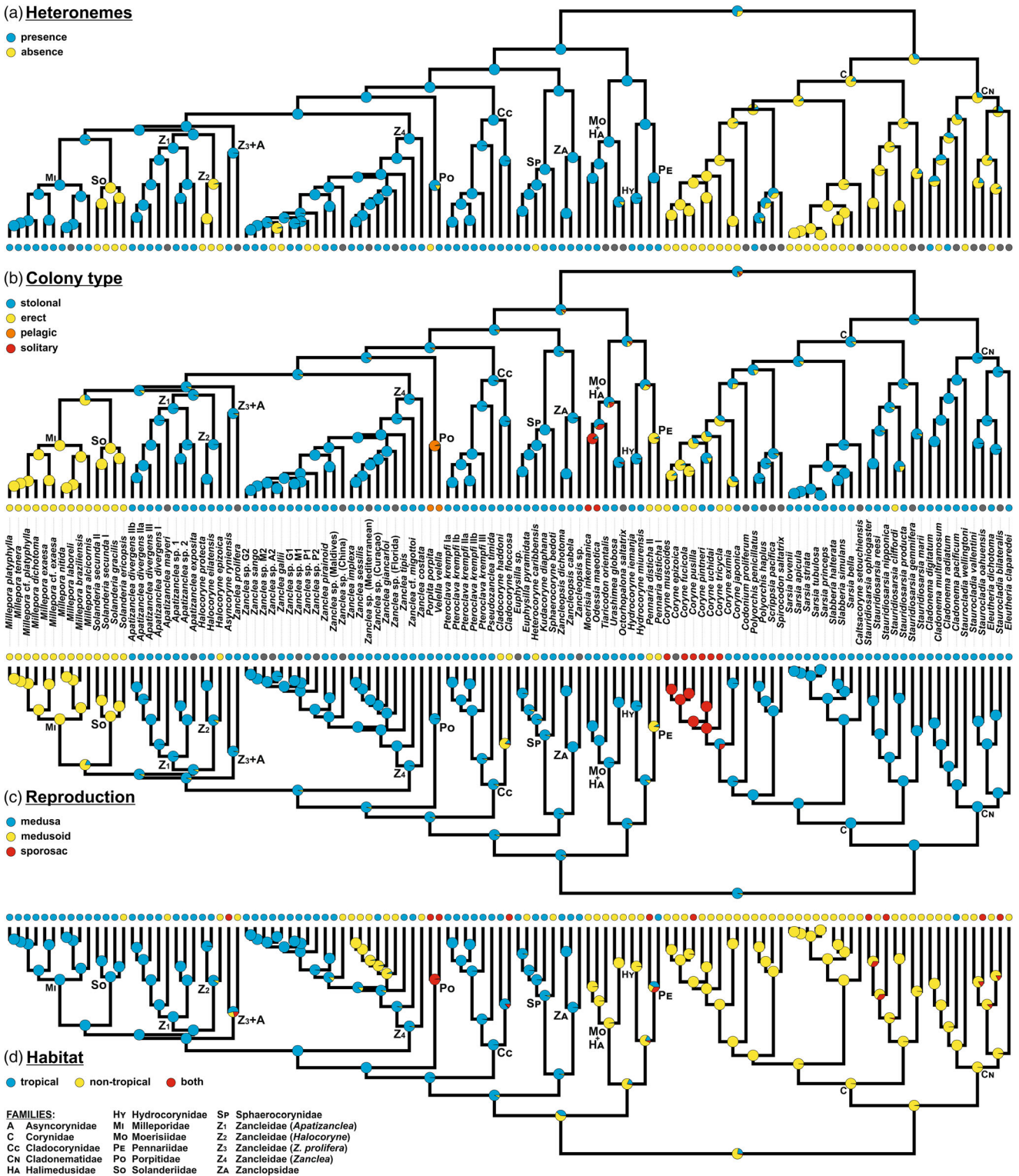

Fig. 10. Ancestral state reconstructions of the characters (a) heteronemes, (b) colony type, (c) reproduction and (d) habitat. Pie charts represent the posterior probability of each node being in each state. Grey circles at tips represent unknown states.

Table 1
Results of the Pagel's tests for correlated evolution of selected characters

Correlation tested	Metrics	Independent	Dependent <i>x</i>	Dependent <i>y</i>	Dependent <i>x</i> & <i>y</i>
Symbiosis (<i>x</i>)—Perisarc (<i>y</i>)	log-L	−63.2738	−58.2949	−55.8664	−54.8848
	AICw	0.0031	0.0606	0.6878	0.2484
	L-ratio		9.9577	14.8147	16.7779
	<i>p</i> -value		0.0069	0.0006	0.0021
Symbiosis (<i>x</i>)—Heteronemes (<i>y</i>)	log-L	−75.2465	−74.0568	−74.0559	−72.5561
	AICw	0.4630	0.2059	0.2061	0.1250
	L-ratio		2.3796	2.3812	5.3808
	<i>p</i> -value		0.3043	0.3040	0.2504
Symbiosis (<i>x</i>)—Polymorphism (<i>y</i>)	log-L	−62.0238	−61.1327	−61.5771	−60.2644
	AICw	0.6069	0.2002	0.1284	0.0646
	L-ratio		1.7821	0.8934	3.5188
	<i>p</i> -value		0.4102	0.6397	0.4750
Symbiosis (<i>x</i>)—Reproduction (<i>y</i>)	log-L	−57.7026	−54.8692	−54.5473	−53.9137
	AICw	0.1373	0.3158	0.4358	0.1111
	L-ratio		5.6667	6.3106	7.5777
	<i>p</i> -value		0.0588	0.0426	0.1083
Symbiosis (<i>x</i>)—Colony (<i>y</i>)	log-L	−53.2162	−45.6010	−42.9474	−42.9035
	AICw	0.0002	0.0581	0.8250	0.1167
	L-ratio		15.2304	20.5375	20.6253
	<i>p</i> -value		0.0005	3.5e^{−5}	0.0004
Symbiosis (<i>x</i>)—Habitat (<i>y</i>)	log-L	−80.1354	−76.3706	−79.4014	−76.1916
	AICw	0.1240	0.7239	0.0350	0.1171
	L-ratio		7.5296	1.4681	7.8876
	<i>p</i> -value		0.0232	0.4750	0.0958

The highest AICw for each analysis is in bold, as well as all statistically significant models. Independent, the two characters evolve independently; Dependent *x*, evolution of *x* depends on evolution of *y*; Dependent *y*, evolution of *y* depends on evolution of *x*; Dependent *x*&*y*, *x* and *y* evolve interdependently; log-L, log-likelihood; AICw, Akaike information criterion weights; L-ratio, likelihood ratio.

Phylogenetic comparative methods

The ancestral state reconstructions and the tests for evolutionary correlation between characters shed light on the evolutionary patterns of the analysed ecological and morphological characters (Figs 9 and 10; Tables 1 and S5), although some of the reconstructed ancestral states were supported by low Bayesian posterior probability (BPP) values and must therefore be considered with caution. Additionally, it must be taken into account that the inclusion of other taxa, genetic data and information in this type of analysis may reshape the observed patterns. The symbiotic lifestyle is likely to have been absent in the most recent common ancestor (MRCA) of the Capitata (node number referring to Fig. S1, *nn* = 1, BPP = 0.69) and Corynida (*nn* = 76, 0.62) (Fig. 9a) and in the latter group it appeared at least three times. Contrarily, in Zancleida it may already have been present in the MRCA of all taxa but Pennariidae, Hydrocorynidae, Halimedesidae and Moerisiidae (*nn* = 3, BPP = 0.73), and was then lost several times, for instance in the MRCA of *Cladocoryne* Rotch, 1871 (*nn* = 60, BPP = 0.8), Porpitidae (*nn* = 53, BPP = 0.94), Milleporidae (*nn* = 10, BPP = 1), Solanderiidae (*nn* = 19, BPP = 1), *Asyncoryne rynthensis* Warren, 1908, and some *Zanclea* species. Regarding the host (Fig. 9b), the only reported associations in the

Corynida are with sponges and molluscs, and the association with Porifera also convergently evolved in the Sphaerocorynidae + Zancleopsidae clade (*nn* = 61, BPP = 0.65). Also the association with molluscs appeared independently twice, in *Zanclea costata* and in *Coryne epizoica* Stechow, 1921. Both the association with octocorals and scleractinian corals appeared only once, in the MRCA of *Pteroclava* + *Pseudozanclea* (*nn* = 55, BPP = 0.83) and in the MRCA of coral-associated *Zanclea* (*nn* = 39, BPP = 1), respectively. The evolution of the association with bryozoans is made uncertain by the low resolution of some phylogenetic relationships among bryozoan-associated species. This association is common in Zancleidae but it is not clear whether it was present in the MRCA of the family and the associations with other organisms represented secondary host shifts, or whether it evolved convergently in different taxa. The association with Bryozoa was already present in the MRCA of *Halocoryne* (*nn* = 30, BPP = 0.97) and in the MRCA of *Apatizanclea* (*nn* = 23, BPP = 0.99).

Regarding the evolution of morphological characters, the perisarc was present in the MRCA of the Capitata (*nn* = 1, BPP = 1) and was subsequently lost multiple times in several Zancleida symbiotic lineages (Fig. 9c), especially in species associated with bryozoans and other cnidarians. The appearance of polymorphic polyps

only occurred among Zancleida (Fig. 9d), possibly in the MRCA of Milleporidae + Solanderiidae + Zancleidae + Asyncorynidae + Porpitidae (nn = 5, BPP = 0.71), but the evolutionary patterns are obscured by phylogenetic uncertainties and by the fact that the character state is still unknown for several species. The heteronemes, here including eurytele and mastigophore capsules only, were present in the MRCA of the Zancleida (nn = 2, BPP = 1) and were then lost a few times in both symbiotic and nonsymbiotic species (Fig. 10a). Contrarily, heteronemes were more probably absent in the MRCA of Corynida (nn = 76, BPP = 0.69) and then evolved again a few times. The type of colony seems to be already stolonal in the MRCA of Capitata (nn = 1, BPP = 0.75) and the erect state convergently evolved in both Corynida and Zancleida, namely in some *Coryne* species, in *Stauridiosarsia cliffordi* (Brinckmann-Voss, 1989), and in Pennariidae (nn = 75, BPP = 0.9), Milleporidae (nn = 10, BPP = 1) and Solanderiidae (nn = 19, BPP = 1) (Fig. 10b). Two peculiar colony types, which are solitary and pelagic, evolved singly in the MRCA of *Moerisia* + *Odessia* (nn = 71, BPP = 0.84) and in the MRCA of Porpitidae (nn = 53, BPP = 0.95), respectively. The reproductive stage, here coded as free-swimming medusa, medusoid and sporosac, was a completely developed medusa in the MRCA of the Capitata (nn = 1, BPP = 0.94), Zancleida (nn = 2, BPP = 0.94) and Corynida (nn = 76, BPP = 1) (Fig. 10c). A reduction was observed convergently in the MRCA of a monophyletic *Coryne* clade (as sporosac) (nn = 82, BPP = 1) and in different Zancleida lineages (as medusoid), namely in the MRCA of Pennariidae (nn = 75, BPP = 0.9), *Cladocoryne* (nn = 60, BPP = 0.83), Solanderiidae (nn = 19, BPP = 1) and Milleporidae (nn = 10, BPP = 1), and also in the species *Heterocoryne caribbensis* Wedler & Larson, 1986.

Finally, we reconstructed the evolution of colonization of tropical habitats and the MRCA of Corynida appeared to live in nontropical (mostly temperate) environments (nn = 76, BPP = 0.98) and only a few Corynida species currently live in tropical waters (Fig. 10d). However, the MRCA of all symbiotic Zancleida species is likely to have been tropical (nn = 3, BPP = 0.94), and most of the extant species included in the analyses currently live in tropical or subtropical environments.

The tests for correlation between the evolution of a symbiotic lifestyle and the other investigated characters revealed significant relationships (Table 1). Specifically, the correlations between the evolution of symbiosis and perisarc were all statistically significant with the best-supported model being that the evolution of perisarc depended on the evolution of symbiosis (AICw = 0.6878, $p = 0.0006$). In a similar manner, also the evolution of the reproductive stage and the colony type seems to have been influenced by the evolution of

symbiosis. In the first case, the only supported model, even if with quite high p -value, was that the evolution of the reproductive stage depended on the evolution of symbiosis (AICw = 0.4358, $p = 0.0426$), whereas in the second case all correlations were statistically significant, with the best-supported model being that the evolution of colony type depended on the evolution of symbiosis (AICw = 0.8250, $p = 3.5e^{-5}$). The evolution of symbiosis depended on the habitat type (AICw = 0.7239, $p = 0.0232$), whereas the models of independent evolution of symbiosis in regards to heteronemes and polymorphism were preferred.

Discussion

Phylogenetic relationships within Capitata

The dataset assembled for this study is the most complete employed so far for phylogenetic analyses of the Capitata. Nevertheless, many taxa still remain unsampled from a genetic point of view, leaving their phylogenetic position and validity unresolved, including 110 species, 13 genera and four families (Schuchert, 2023). The Capitata was recovered as a monophyletic group composed of the two clades Zancleida and Corynida, in agreement with previous work (Nawrocki et al., 2010). Internal relationships within Corynida were also in agreement with Nawrocki et al. (2010), with the two monophyletic families Corynidae and Cladonematidae. However, our sampling mostly focused on Zancleida species, in order to disentangle the remaining uncertainties in the phylogenetic relationships within this group. By including previously unsampled species and genera, and by employing a wider set of DNA regions compared to previous studies, we were able to shed light on the phylogeny of Zancleida and on the relationships among different families.

Most of the analysed families resulted to be monophyletic. Exceptions are represented by the Halimedusidae + Moerisiidae clade and by the Zancleidae. In the first group, *Tiaricodon orientalis*, currently included in Halimedusidae, showed higher affinities with Moerisiidae. It must be taken into account, however, that the two other Halimedusidae species included (i.e. *Urashimea globosa* Kishinouye, 1910 and *Octorhopalona saltatrix* Toshino, Yamamoto & Saito, 2022) were sequenced only in their 16S rRNA gene and that the other species and genera (e.g. *Halimedusa typus* Bigelow, 1916, the type species of Halimedusidae) should be sequenced to obtain a comprehensive overview of these two families.

The family Zancleidae is already known to be a problematic group (Nawrocki et al., 2010; Maggioni et al., 2018). The polyphyletic nature of this family

was further supported by our new data, with the recovery of four distinct clades. Indeed, the general morphology of the genus *Zanclaea*, as seen in *Z. costata*, is likely to represent an ancestral plesiomorphic condition that was retained in many species, but from which much more derived groups such as Milleporidae and Solanderiidae also evolved. The "true" *Zanclaea* genus and, by consequence, the "true" Zancleidae family formed a cohesive group with high nodal support in all analyses. This clade contained both well-established species and undeterminable or cryptic species, such as the coral-associated *Zanclaea* complex (Maggioni et al., 2022a), that could not be properly described owing to the lack of suitable morphological characters or to incomplete knowledge of the life cycles. Many *Zanclaea* species were previously described rather superficially and incompletely, and without DNA data. These issues exacerbated an already problematic taxon, complicating the description of new species. It is now clear that new species descriptions must always include genetic data, to assess the divergence with already sequenced taxa and to make possible future comparisons and identifications (Tautz et al., 2003). Concomitantly, flexible nomenclature systems have also been proposed when species descriptions are not possible, for instance when dealing with cryptic species, making possible the transfer of DNA-based taxonomic and biodiversity knowledge across disciplines (Morard et al., 2016). Given these reasons, we stress the importance of avoiding new species descriptions without complete morphological information and/or DNA data.

The position of the remaining zancleid species clustered with members of the families Asyncorynidae, Milleporidae and Solanderiidae in a clade whose internal phylogenetic relationships were not fully resolved. *Zanclaea prolifera* showed a sister-group relationship with *Asyncoryne rnyiensis*, although with low statistical support. Nawrocki et al. (2010) suggested that *Z. prolifera* may indeed need to be transferred to Asyncorynidae, also because this species is known only from its medusa stage (Uchida and Sugiura, 1976) and *Zanclaea* and *Asyncoryne* species have almost identical medusae (Migotto, 1996). This issue currently could not be resolved, and only the discovery of the *Z. prolifera* polyps together with a wider sampling could clarify the systematic affinities of this species.

Two other zancleid clades were recovered from our analyses, but their phylogenetic relationships could not be resolved. For this reason, and because of the intergrading morphologies shared by all zancleid species, it was impossible to split the Zancleidae into different families, and taxonomic actions were undertaken only at the genus level. Specifically, a first group included *Halocoryne epizoica* and two species previously assigned to *Zanclaea* (Hastings, 1932; Pica et al., 2017) and now transferred to *Halocoryne*. These three species

showed some common traits that also are found in some other zancleid species; however, they lack perisarc and euryteles and are exclusively associated with bryozoans, whose skeleton is modified by the presence of the symbionts.

The last zancleid group comprised species previously ascribed to the genus *Zanclaea* (Puce et al., 2002; Maggioni et al., 2018; Schuchert and Collins, 2021) and showing some peculiarities. Given their genetic affinities and divergence from other species, they were included in the newly erected genus *Apatizanclaea*. Interestingly, all known polyps have macrobasal holotrichous euryteles, no perisarc, and are associated with bryozoans, whereas all known medusae have two bulbs and two tentacles. These features are shared with a few other species (Boero et al., 2000), but never together, and constitute diagnostic characters for the genus.

Finally, Milleporidae and Solanderiidae were recovered as sister groups, even if with moderate nodal support. These two families have modified erect colonies, either with production of a calcium carbonate skeleton or with the perisarc forming an internal chitinous skeleton, respectively. Other taxa not sampled here may be related to Milleporidae and Solanderiidae species, showing specific structures in their colonies, such as internal (*Pseudosolanderia* Bouillon & Gravier-Bonnet, 1988) or external (*Rosalinda* Totton, 1949, *Teissiera* Bouillon, 1974) chitinous skeletons. In a similar way to the Solanderiidae, the genus *Pseudosolanderia* has erect flabellate colonies with an internal chitinous skeleton, which nevertheless shows differences compared to *Solanderia* skeletons. Also, their cnidomes are different (Bouillon and Gravier-Bonnet, 1987; Bouillon et al., 1992). *Teissiera* and *Rosalinda* are characterized by stolonal colonies, often associated with other organisms, both genera have chitinous basal plates, and, in a similar way to *Pseudosolanderia*, have heteronemes in their cnidome (Bouillon, 1974; Bouillon and Gravier-Bonnet, 1987; Petersen, 1990; Gil et al., 2021). As noted by Petersen (1990), it is not always clear whether these heteronemes are euryteles or mastigophores, which also has been observed in the genus *Millepora* (Arrigoni et al., 2018). *Teissiera* is further differentiated by having polymorphic polyps and medusae with ocelli (Bouillon, 1974, 1978). The inclusion of these three genera in future molecular analyses will hopefully help clarifying their phylogenetic position, and the relationships among the Asyncorynidae, Milleporidae, Solanderiidae and Zancleidae, and will shed light on the evolution of colony modifications.

Character evolution in Capitata

Cnidarians, and especially hydrozoans, are known for their large morphological diversity and variety of life cycles (Bouillon et al., 2006; Cartwright and

Nawrocki, 2010). All three life stages (i.e. larva, polyp and medusa) are extremely diversified in the Hydrozoa, and morphological simplification or even reduction is a widespread phenomenon in the class (Bouillon et al., 2006). This large variability, together with the common intergrading morphologies between species, genera and even families, hamper the understanding of both taxonomy and evolution of several hydrozoan taxa. However, the use of molecular data to test the evolution of morphological and ecological traits has proven very useful in different taxa, highlighting the frequent presence of convergent and parallel evolutionary patterns (Leclère et al., 2007, 2009; Cartwright and Nawrocki, 2010; Maggioni et al., 2022a, b). Indeed, despite the presence of synapomorphies characterizing many taxa, homoplasy is quite a common phenomenon in hydrozoans, as demonstrated by, among others, the reduction of the medusa stage, the presence of polymorphic polyps and the colony type (Cartwright and Nawrocki, 2010).

Our results are in line with these previous findings, because all of the examined characters showed some degree of convergent or parallel evolution. Indeed, regarding morphological characters, our ancestral state reconstructions showed that the perisarc, polymorphic polyps, heteronemes, stolonial colonies and reduced medusa were frequently and independently lost among the Capitata. Likewise, the establishment of a symbiotic lifestyle was acquired multiple times and then lost again in certain taxa. The MRCA of Capitata seemingly had nonsymbiotic stolonial polyps with perisarc and heteronemes, and a free-swimming medusa, whereas the presence of polymorphic polyps remained unclear. Symbiosis, when present, is in most cases obligate for the capitate hydrozoans (exceptions are, for instance, *Z. giancarloii*, *Z. sessilis*, *Zanclaea* cf. *migottoi*). Interestingly, coral-associated *Zanclaea* species represent the only known case of hydrozoans associated with scleractinian corals, whereas associations with octocorals, sponges, molluscs, bryozoans and other organisms are found not only in other noncapitate hydrozoans, but also in other cnidarian taxa (e.g. Puce et al., 2008; Kise et al., 2023).

Our analyses proved that the establishment of a symbiotic lifestyle may have influenced the evolution of other morphological characters, as already hypothesized by previous authors (Boero et al., 2000; Puce et al., 2002). Specifically, on the one hand, the best-supported models of correlated evolution of the characters were that the evolution of perisarc, reproductive stage and colony type depended on the evolution of the symbiotic lifestyle. On the other hand, the independent evolution of heteronemes and polymorphism related to the evolution of symbiosis were most supported. In our view, the most obvious result relates to the evolution of perisarc, with the loss of this structure

being associated with the symbiotic lifestyle. The loss of perisarc convergently occurred in some zancleid species associated with bryozoans and scleractinian corals, and in a cladocorynid species associated with octocorals. All of these associations are likely to be obligate for the hydrozoan, and the loss of a protective perisarc may have been promoted by a higher integration with the hosts, which often cover the hydrorhiza with skeleton or tissue, and may be indicative of a high specificity of the association (Boero et al., 2000; Puce et al., 2002; Montano et al., 2015a, b; Maggioni et al., 2020c). The loss of the perisarc, for instance, allows the species *Zanclaea margaritae* Panthos & Bythell, 2010 to firmly, but dynamically, attach to the host coral skeleton using desmocytes, in a similar fashion to how the coral tissue attaches to its skeleton (Pantos and Hoegh-Guldberg, 2011). Previous works, focusing on other hydrozoan species, also found a correlated evolution of certain characters in relation to the symbiotic lifestyle. For instance, in hydractiniid species, Miglietta and Cunningham (2012) detected a relationship between the medusa loss and the specialization of polyps to a single type of host and a relationship between the colony type (e.g. encrusting or reticulate) and the ability to live on specific hosts, thus highlighting the importance of symbiosis in the evolution of phenotypic and ecological traits and *vice versa*. However, the same authors did not find a clear relationship between the evolution of the medusa stage and the colony type, opposite to what was found by Leclère et al. (2009) for leptothecate hydrozoans. Indeed, the medusa stage has been repeatedly lost during hydrozoan evolution, and a class-wide analysis is needed to possibly clarify the drivers of medusa loss or reduction. In this sense, important steps forward have recently been made, with the discovery that the loss of the homeobox gene *Tlx* is correlated with medusa suppression in multiple clades (Travert et al., 2023).

Finally, we found a correlation between the evolution of the symbiotic lifestyle and the colonization of tropical habitats, with most symbiotic species inhabiting the latter environments. Tropical coral reefs are biodiversity hotspots, showing an incredible diversity of species and exploitable habitats (Fisher et al., 2015; Hoeksema, 2017), and several symbiotic associations are known to involve coral reef benthic organisms as hosts (Montano, 2020), one of which is unique by involving one Capitata species as the host and a species of the hydrozoan suborder Filifera as an epibiont (Montano et al., 2020). The richness of symbiotic relationships in these environments may be promoted by the vast biodiversity, the three-dimensional habitats provided by corals and other organisms, and the competition for space and resources (Gates and Ainsworth, 2011). Therefore, the colonization of tropical habitats may have spurred the establishment of

symbiotic relationships between capitata hydrozoans and other benthic organisms, and this, in turn, also may have resulted in adaptive radiations in symbiotic species, as already known for different coral-associated organisms (e.g. Gittenberger and Gittenberger, 2005, 2011; Tsang et al., 2014; van der Meij et al., 2015; Kunihiro et al., 2019; Fritts-Penniman et al., 2020; Mehrotra et al., 2020), driven for instance by host shifts. However, a more comprehensive sampling and a time-calibrated phylogeny of the Capitata, at the moment still not possible because of the lack of reliable fossil records, are needed to test this hypothesis.

Conclusions

The molecular phylogenetic hypothesis obtained here represents the most comprehensive scenario produced so far for the Capitata, shedding light on the systematic affinities and evolution of the group. Most of the families were recovered as monophyletic, with a striking exception represented by the polyphyletic family Zancleidae, making necessary the transfer of species in different genera and the establishment of a new genus. The taxonomic and systematic uncertainties in this family are exacerbated by the paucity of diagnostic morphological characters and the partially unknown life cycles, and future integrative research targeting both already sampled and unsampled taxa is strongly needed to unravel the complex diversity and evolution of this group.

The analyses of the evolution of morphological and ecological characters revealed high levels of convergent or parallel evolution in divergent taxa, with independent losses of several traits. In particular, symbiosis appeared multiple times in the evolutionary history of the Capitata, especially in the Zancleida, which is likely to have been influenced by the colonization of tropical habitats, and likely to have influenced the evolution of other morphological characters, highlighting the importance of symbiosis in animal evolution.

Acknowledgements

The authors wish to thank all the people involved in collecting material or organizing sampling campaigns, including Luca Fallati (University of Milano-Bicocca), Luca Saponari (Nature Seychelles), Stephen Keable (Australian Museum), Penny Berents (Australian Museum), Anne Hoggett (Australian Museum), Lyle Vail (Australian Museum), Francesca Strano (Victoria University of Wellington), Valerio Micaroni (Victoria University of Wellington), and the staff of CARMABI Marine Research Center at Curaçao. Permissions relevant to undertaking the research have been obtained from the applicable governmental agencies. The work was partially

funded by PADI Foundation grant nos 28634 and 14384 to DM and SM. SM is grateful to Naturalis Biodiversity Center for providing Martin Fellowships, which supported fieldwork in Curaçao. Samples from Eilat (Israel) were collected during the HyDRa Project funded by the EU FP7 Research Infrastructure Initiative ‘ASSEMBLE’ (grant no. 227799) to DP. Financial support to DP for collecting samples at Lizard Island (Australia) was provided by the 2018 John and Laurine Proud Fellowship and the Australian Museum’s Lizard Island Research Station. Finally, we would like to thank Maria Mendoza Becerril for re-analysing material in the collection: Cnidarians of the Gulf of Mexico and Mexican Caribbean “Lourdes Segura” (Faculty of Science, Multidisciplinary Teaching and Research Unit, Sisal, Yucatán).

Conflict of interest

None declared.

Data availability statement

The genetic data underlying this article are available in the GenBank Nucleotide Database and can be accessed with accession numbers OQ955308–OQ955478, OQ956203–OQ956256, OQ984068–OQ984146, OQ992945–OQ993031. Alignments, raw phylogenetic trees, and R scripts and files used for the phylogenetic comparative methods are available at: <https://figshare.com/s/ff00a8fe9e61b1bde4e3>.

References

- Abouna, S., Gonzalez-Rizzo, S., Grimont, A. and Gros, O., 2015. First description of sulphur-oxidizing bacterial symbiosis in a cnidarian (Medusozoa) living in sulphidic shallow-water environments. *PloS One* 10, e0127625.
- Altuna, Á., 2016. The life cycle of symbiotic *Zanclea sessilis* (Hydrozoa: Zancleidae) colonies with polymorphic hydranths from the Bay of Biscay. *Mar. Biodivers.* 46, 901–910.
- Appeltans, W., Ahyong, S.T., Anderson, G., Angel, M.V., Artois, T., Bailly, N., Bamber, R., Barber, A., Bartsch, I., Berta, A., Błażewicz-Paszkowycz, M., Bock, P., Boxshall, G., Boyko, C.B., Brandão, S.N., Bray, R.A., Bruce, N.L., Cairns, S.D., Chan, T.Y., Cheng, L., Collins, A.G., Cribb, T., Curini-Galletti, M., Dahdouh-Guebas, F., Davie, P.J., Dawson, M.N., De Clerck, O., Decock, W., De Grave, S., de Voogd, N.J., Domning, D.P., Emig, C.C., Erséus, C., Eschmeyer, W., Fauchald, K., Fautin, D.G., Feist, S.W., Franssen, C.H., Furuya, H., Garcia-Alvarez, O., Gerken, S., Gibson, D., Gittenberger, A., Gofas, S., Gómez-Daglio, L., Gordon, D.P., Guiry, M.D., Hernandez, F., Hoeksema, B.W., Hopcroft, R.R., Jaume, D., Kirk, P., Koedam, N., Koeneemann, S., Kolb, J.B., Kristensen, R.M., Kroh, A., Lambert, G., Lazarus, D.B., Lemaitre, R., Longshaw, M., Lowry, J., Macpherson, E., Madin, L.P., Mah, C., Mapstone, G., McLaughlin, P.A., Mees, J., Meland, K., Messing, C.G., Mills, C.E., Molodtsova, T.N., Mooi, R., Neuhaus, B., Ng, P.K., Nielsen, C., Norenburg, J., Opresko, D.M., Osawa, M., Paulay, G., Perrin, W., Pilger, J.F., Poore, G.C., Pugh, P., Read, G.B.,

- Reimer, J.D., Rius, M., Rocha, R.M., Saiz-Salinas, J.I., Scarabino, V., Schierwater, B., Schmidt-Rhaesa, A., Schnabel, K.E., Schotte, M., Schuchert, P., Schwabe, E., Segers, H., Self-Sullivan, C., Shenkar, N., Siegel, V., Sterrer, W., Stöhr, S., Swalla, B., Tasker, M.L. and Costello, M.J., 2012. The magnitude of global marine species diversity. *Curr. Biol.* 22, 2189–2202.
- Arrigoni, R., Maggioni, D., Montano, S., Hoeksema, B.W., Seveso, D., Shlesinger, T., Terraneo, T.I., Tietbohl, M.D. and Berumen, M.L., 2018. An integrated morpho-molecular approach to delineate species boundaries of *Millepora* from the Red Sea. *Coral Reefs* 37, 967–984.
- Banaszak, A.T., Iglesias Prieto, R. and Trench, R.K., 1993. *Scripsiella velellae*, new species (Peridinales) and *Gloedinium viscum*, new species (Phytodinales) dinoflagellate symbionts of two hydrozoans (Cnidaria). *J. Phycol.* 29, 517–528.
- Bentlage, B. and Collins, A.G., 2021. Tackling the phylogenetic conundrum of Hydroidolina (Cnidaria: Medusozoa: Hydrozoa) by assessing competing tree topologies with targeted high-throughput sequencing. *PeerJ* 9, e12104.
- Boero, F., 1987. Evolutionary implications of habitat selection in the hydroids of *Posidonia oceanica* meadows. In: Bouillon, J., Boero, F., Cicogna, F. and Cornelius, P.F.S. (Eds.), *Modern Trends in the Systematics, Ecology and Evolution of Hydroids and Hydromedusae*. Clarendon Press, Oxford, UK, pp. 251–256.
- Boero, F. and Sarà, M., 1987. Motile sexual stages and evolution of Leptomedusae (Cnidaria). *Boll. Zool.* 54, 131–139.
- Boero, F., Bouillon, J. and Gravili, C., 1991. The life cycle of *Hydrichthys mirus* (Cnidaria: Hydrozoa: Anthomedusae: Pandaeidae). *Zool. J. Linn. Soc.* 101, 189–199.
- Boero, F., Bouillon, J. and Gravili, C., 2000. A survey of *Zanclaea*, *Halocoryne* and *Zanclella* (Cnidaria, Hydrozoa, Anthomedusae, Zanclaeidae) with description of new species. *Ital. J. Zool.* 67, 93–124.
- Bogdanov, E.A., Vishnyakov, A.E. and Ostrovsky, A.N., 2022. From Procaryota to Eumetazoa: symbiotic associations in fossil and recent bryozoans. *Paleontol. J.* 56, 836–851.
- Bouillon, J., 1974. Description de *Teissiera milleporoides*, nouveau genre et nouvelle espèce de Zanclaeidae des Seychelles (Hydrozoaires; Athécates–Anthomédues), avec une révision des hydroïdes “Pteronematoidea”. *Cah. Biol. Mar.* 15, 113–154.
- Bouillon, J., 1978. Hydroméduses de la mer de Bismarck (Papouasie, Nouvelle-Guinée). Partie 1: Anthomedusae Capitata (Hydrozoa—Cnidaria). *Cah. Biol. Mar.* 19, 249–297.
- Bouillon, J. and Gravier-Bonnet, N., 1987. *Pseudosolanderia picardi*, nouveau genre et nouvelle espèce de Rosalindidae de la Réunion (Anthomedusae, Hydrozoa, Cnidaria). *Bull. Mus. Natl. Hist. Nat.* 4, 755–771.
- Bouillon, J., Wouters, K. and Boero, F., 1992. Étude des Solanderiidae de la Baie de Hansa (Papouasie Nouvelle-Guinée) avec une révision du genre *Solanderia* (Cnidaria, Hydrozoa). *Bull. Inst. R. Sci. Nat. Belgique, Biol.* 62, 5–33.
- Bouillon, J., Gravili, C., Gili, J.M. and Boero, F., 2006. An Introduction to Hydrozoa. Publications Scientifiques du Muséum, Paris, France.
- Browne, E.T., 1906. A report on the medusae found in the Firth of Clyde (1901–1902). *Proc. R. Soc. Edinb.* 25, 738–778.
- Calder, D.R., 1988. Shallow-water hydroids of Bermuda: The Athecatae. *Life Sci. Contrib. R. Ont. Mus.* 148, 1–107.
- Cartwright, P. and Nawrocki, A.M., 2010. Character evolution in Hydrozoa (phylum Cnidaria). *Integr. Comp. Biol.* 50, 456–472.
- Castresana, J., 2000. Selection of conserved blocks from multiple alignments for their use in phylogenetic analysis. *Mol. Biol. Evol.* 17, 540–552.
- Cerrano, C., Amoretti, D. and Bavestrello, G., 1997. The polyp and the medusa of *Zanclaea costata* Gegenbaur (Cnidaria, Hydrozoa). *Ital. J. Zool.* 64, 177–179.
- Collins, A.G., Winkelmann, S., Hadrys, H. and Schierwater, B., 2005. Phylogeny of Capitata and Corynidae (Cnidaria, Hydrozoa) in light of mitochondrial 16S rDNA data. *Zool. Scr.* 34, 91–99.
- Di Camillo, C.G., Bavestrello, G., Cerrano, C., Gravili, C., Piraino, S., Puce, S. and Boero, F., 2017. Hydroids (Cnidaria, Hydrozoa): A neglected component of animal forests. In: Rossi, S., Bramanti, L., Gori, A. and Orejas, C. (Eds.), *Marine Animal Forests*. Springer, Cham, Switzerland, pp. 397–427.
- Dreyer, N., Tsai, P.C., Olesen, J., Kolbasov, G.A., Høeg, J.T. and Chan, B.K.K., 2022. Independent and adaptive evolution of phenotypic novelties driven by coral symbiosis in barnacle larvae. *Evolution* 76, 139–157.
- Drummond, A.J., Suchard, M.A., Xie, D. and Rambaut, A., 2012. Bayesian phylogenetics with BEAUti and the BEAST 1.7. *Mol. Biol. Evol.* 29, 1969–1973.
- Fisher, R., O’Leary, R.A., Low-Choy, S., Mengersen, K., Knowlton, N., Brainard, R.E. and Caley, M.J., 2015. Species richness on coral reefs and the pursuit of convergent global estimates. *Curr. Biol.* 25, 500–505.
- Fritts-Penniman, A.L., Gosliner, T.M., Ngurah Mahardika, G. and Barber, P.H., 2020. Cryptic ecological and geographic diversification in coral-associated nudibranchs. *Mol. Phylogenet. Evol.* 144, 106698.
- Galea, H.R., 2008. On a collection of shallow-water hydroids (Cnidaria: Hydrozoa) from Guadeloupe and les Saintes, French Lesser Antilles. *Zootaxa* 1878, 1–54.
- Galea, H.R. and Maggioni, D., 2020. Plumularioid hydroids (Cnidaria: Hydrozoa) from off New Caledonia collected during KANACONO and KANADEEP expeditions of the French Tropical Deep-Sea Benthos Program. *Eur. J. Taxon.* 708, 1–58.
- Gates, R.D. and Ainsworth, T.D., 2011. The nature and taxonomic composition of coral symbiomes as drivers of performance limits in scleractinian corals. *J. Exp. Mar. Biol. Ecol.* 408, 94–101.
- Gegenbaur, C., 1857. Versuch eines Systems der Medusen, mit Beschreibung neuer oder wenig gekannter Formen; zugleich ein Beitrag zur Kenntnis der Fauna des Mittelmeeres. *Z. Wiss. Zool.* 8, 202–273.
- Gil, M., Freiwald, A. and Ramil, F., 2021. Two new species of *Rosalinda* (Cnidaria, Hydrozoa, Anthoathecata) from west African cold-water coral mounds. *Deep Sea Res. Part I Oceanogr. Res. Pap.* 168, 103436.
- Gittenberger, A. and Gittenberger, E., 2005. A hitherto unnoticed adaptive radiation: epitoniid species (Gastropoda: Epitoniidae) associated with corals (Scleractinia). *Contrib. Zool.* 74, 125–203.
- Gittenberger, A. and Gittenberger, E., 2011. Cryptic, adaptive radiation of endoparasitic snails: sibling species of *Leptoconchus* (Gastropoda: Coralliophilidae) in corals. *Org. Divers. Evol.* 11, 21–41.
- Gittenberger, A. and Hoeksema, B.W., 2013. Habitat preferences of coral-associated wentletrap snails (Gastropoda: Epitoniidae). *Contrib. Zool.* 82, 1–25.
- Goloboff, P.A., 1999. Analyzing large data sets in reasonable times: solutions for composite optima. *Cladistics* 15, 415–428.
- Goloboff, P.A., Farris, J.S. and Nixon, K.C., 2008. TNT, a free program for phylogenetic analysis. *Cladistics* 24, 774–786.
- Gravili, C., Boero, F. and Bouillon, J., 1996. *Zanclaea* species (Hydroidomedusae, Anthomedusae) from the Mediterranean. *Sci. Mar.* 60, 99–108.
- Grischenko, A.V., Gordon, D.P., Taylor, P.D., Kuklinski, P., Denisenko, N.V., Spencer Jones, M.E. and Ostrovsky, A.N., 2022. Taxonomy, ecology and zoogeography of the recent species of *Rhamphostomella* Lorenz, 1886 and *Mixtoscutella* gen. nov. (Bryozoa, Cheilostomata). *Zootaxa* 5131, 1–115.
- Haeckel, E., 1879. Das System der Medusen. Erster Theil einer Monographie der Medusen. Erste Hälfte des ersten Theils: System der Craspedoten. *Denkschr. Med. Naturw. Ges. Jena* 1, 1–360.
- Hand, C. and Hendrickson, J.R., 1950. A two-tentacled, commensal hydroid from California (Limnomedusae, *Probosciodactyla*). *Biol. Bull.* 99, 74–87.
- Hastings, A.B., 1932. The Polyzoa, with a note on an associated hydropolyp. *Sci. Rep. Gr. Barrier Reef Exped.* 4, 399–458.

- Hoeksema, B.W., 2017. The hidden biodiversity of tropical coral reefs. *Biodiversity* 18, 8–12.
- Horká, I., De Grave, S., Franssen, C.H.J.M., Petrušek, A. and Ďuriš, Z., 2016. Multiple host switching events shape the evolution of symbiotic palaemonid shrimps (Crustacea: Decapoda). *Sci. Rep.* 6, 26486.
- Huelsbeck, J.P., Nielsen, R. and Bollback, J.P., 2003. Stochastic mapping of morphological characters. *Syst. Biol.* 52, 131–158.
- Katoh, K. and Standley, D.M., 2013. MAFFT multiple sequence alignment software version 7: improvements in performance and usability. *Mol. Biol. Evol.* 30, 772–780.
- Kayal, E., Bentlage, B., Sabrina Pankey, M., Ohdera, A.H., Medina, M., Plachetzki, D.C., Collins, A.G. and Ryan, J.F., 2018. Phylogenomics provides a robust topology of the major cnidarian lineages and insights on the origins of key organismal traits. *BMC Evol. Biol.* 18, 1–18.
- Kise, H., Santos, M.E.A., Fourreau, C.J.L., Iguchi, A., Goto, R. and Reimer, J.D., 2023. Evolutionary patterns of host switching, lifestyle mode, and the diversification history in symbiotic zoantharians. *Mol. Phylogenet. Evol.* 182, 107732.
- Kumar, S., Stecher, G., Li, M., Knyaz, C. and Tamura, K., 2018. MEGA X: molecular evolutionary genetics analysis across computing platforms. *Mol. Biol. Evol.* 35, 1547–1549.
- Kunihiro, S., Farenzena, Z., Hoeksema, B.W., Groenenberg, D.S., Hermanto, B. and Reimer, J.D., 2019. Morphological and phylogenetic diversity of *Waminoa* and similar flatworms (Acoelomorpha) in the western Pacific Ocean. *Fortschr. Zool.* 136, 125692.
- Lanfear, R., Calcott, B., Ho, S.Y. and Guindon, S., 2012. PartitionFinder: combined selection of partitioning schemes and substitution models for phylogenetic analyses. *Mol. Biol. Evol.* 29, 1695–1701.
- Leclère, L., Schuchert, P. and Manuel, M., 2007. Phylogeny of the Plumularioidea (Hydrozoa, Leptothecata): evolution of colonial organisation and life cycle. *Zool. Scr.* 36, 371–394.
- Leclère, L., Schuchert, P., Cruaud, C., Couloux, A. and Manuel, M., 2009. Molecular phylogenetics of Thecata (Hydrozoa, Cnidaria) reveals long-term maintenance of life history traits despite high frequency of recent character changes. *Syst. Biol.* 58, 509–526.
- Maddison, W.P. and Maddison, D.R., 2006. Mesquite: a modular system for evolutionary analysis. Available at: <http://www.mesquiteproject.org> (accessed 4 April 2023).
- Maggioni, D., Montano, S., Arrigoni, R., Galli, P., Puce, S., Pica, D. and Berumen, M.L., 2017. Genetic diversity of the *Acropora*-associated hydrozoans: new insight from the Red Sea. *Mar. Biodivers.* 47, 1045–1055.
- Maggioni, D., Arrigoni, R., Galli, P., Berumen, M.L., Seveso, D. and Montano, S., 2018. Polyphyly of the genus *Zanclaea* and family Zanclidae (Hydrozoa, Capitata) revealed by the integrative analysis of two bryozoan-associated species. *Contrib. Zool.* 87, 87–104.
- Maggioni, D., Schiavo, A., Ostrovsky, A.N., Seveso, D., Galli, P., Arrigoni, R., Berumen, M.L., Benzoni, F. and Montano, S., 2020a. Cryptic species and host specificity in the bryozoan-associated hydrozoan *Zanclaea divergens* (Hydrozoa, Zanclidae). *Mol. Phylogenet. Evol.* 151, 106893.
- Maggioni, D., Saponari, L., Seveso, D., Galli, P., Schiavo, A., Ostrovsky, A.N. and Montano, S., 2020b. Green fluorescence patterns in closely related symbiotic species of *Zanclaea* (Hydrozoa, Capitata). *Diversity* 12, 78.
- Maggioni, D., Montano, S., Voigt, O., Seveso, D. and Galli, P., 2020c. A mesophotic hotel: the octocoral *Bebryce* cf. *grandicalyx* as a host. *Ecology* 101, e02950.
- Maggioni, D., Schuchert, P., Arrigoni, R., Hoeksema, B.W., Huang, D., Strona, G., Seveso, D., Berumen, M.L., Montalbetti, E., Collins, R., Galli, P. and Montano, S., 2021. Integrative systematics illuminates the relationships in two sponge-associated hydrozoan families (Capitata: Sphaerocorynidae and Zanclaeopsidae). *Contrib. Zool.* 90, 487–525.
- Maggioni, D., Arrigoni, R., Seveso, D., Galli, P., Berumen, M.L., Denis, V., Hoeksema, B.W., Huang, D., Manca, F., Pica, D., Puce, S., Reimer, J.D. and Montano, S., 2022a. Evolution and biogeography of the *Zanclaea*-Scleractinia symbiosis. *Coral Reefs* 41, 779–795.
- Maggioni, D., Garese, A., Huang, D., Hoeksema, B.W., Arrigoni, R., Seveso, D., Galli, P., Berumen, M.L., Montalbetti, E., Pica, D., Torsani, F. and Montano, S., 2022b. Diversity, host specificity and biogeography in the Cladocorynidae (Hydrozoa, Capitata), with description of a new genus. *Cladistics* 38, 13–37.
- Manca, F., Puce, S., Caragnano, A., Maggioni, D., Pica, D., Seveso, D., Galli, P. and Montano, S., 2019. Symbiont footprints highlight the diversity of scleractinian-associated *Zanclaea* hydrozoans (Cnidaria, Hydrozoa). *Zool. Scr.* 48, 399–410.
- Maronna, M.M., Miranda, T.P., Peña Cantero, A.L., Barbeitos, M.S. and Marques, A.C., 2016. Towards a phylogenetic classification of Leptothecata (Cnidaria, Hydrozoa). *Sci. Rep.* 6, 18075.
- Mastrototaro, F., Aguilar, R., Chimienti, G., Gravili, C. and Boero, F., 2016. The rediscovery of *Rosalinda inerustans* (Cnidaria: Hydrozoa) in the Mediterranean Sea. *Ital. J. Zool.* 83, 244–247.
- Mehrotra, R., Arnold, S., Wang, A., Chavanich, S., Hoeksema, B.W. and Caballer, M., 2020. A new species of coral-feeding nudibranch (Mollusca: Gastropoda) from the Gulf of Thailand. *Mar. Biodivers.* 50, 36.
- van der Meij, S.E., Franssen, C.H., Pasman, L.R. and Hoeksema, B.W., 2015. Phylogenetic ecology of gall crabs (Cryptochiridae) as associates of mushroom corals (Fungiidae). *Ecol. Evol.* 5, 5770–5780.
- Mendonça, L.M.C., Guimarães, C.R.P. and Haddad, M.A., 2022. Taxonomy and diversity of hydroids (Cnidaria: Hydrozoa) of Sergipe, Northeast Brazil. *Zoologia* 39, e21032.
- Mendoza-Becerril, M.A., Simões, N. and Genzano, G., 2018. Benthic hydroids (Cnidaria, Hydrozoa) from Alacranes reef, Gulf of Mexico, Mexico. *Bull. Mar. Sci.* 94, 125–142.
- Miglietta, M.P. and Cunningham, C.W., 2012. Evolution of life cycle, colony morphology, and host specificity in the family Hydractiniidae (Hydrozoa, Cnidaria). *Evolution* 66, 3876–3901.
- Miglietta, M.P., Maggioni, D. and Matsumoto, Y., 2019. Phylogenetics and species delimitation of two Hydrozoa (phylum Cnidaria): *Turritopsis* (McCrady, 1857) and *Pennaria* (Goldfuss, 1820). *Mar. Biodivers.* 49, 1085–1100.
- Migotto, A.E., 1996. Benthic shallow-water hydroids (Cnidaria, Hydrozoa) of the coast of São Sebastião, Brazil, including a checklist of Brazilian hydroids. *Zool. Verh.* 306, 1–125.
- Miller, M.A., Pfeiffer, W. and Schwartz, T., 2010. Creating the CIPRES Science Gateway for inference of large phylogenetic trees. In: Proceedings of the Gateway Computing Environments (GCE) Workshop 2010. New Orleans, LA: IEEE, pp. 1–8. <https://doi.org/10.1109/GCE.2010.5676129>.
- Montano, S., 2020. The extraordinary importance of coral-associated fauna. *Diversity* 12, 357.
- Montano, S., Arrigoni, R., Pica, D., Maggioni, D. and Puce, S., 2015a. New insights into the symbiosis between *Zanclaea* (Cnidaria, Hydrozoa) and scleractinians. *Zool. Scr.* 44, 92–105.
- Montano, S., Fattorini, S., Parravicini, V., Berumen, M.L., Galli, P., Maggioni, D., Arrigoni, R., Seveso, D. and Strona, G., 2017. Corals hosting symbiotic hydrozoans are less susceptible to predation and disease. *Proc. R. Soc. B: Biol. Sci.* 284, 20172405.
- Montano, S., Maggioni, D., Arrigoni, R., Seveso, D., Puce, S. and Galli, P., 2015b. The hidden diversity of *Zanclaea* associated with scleractinians revealed by molecular data. *PLoS One* 10, e0133084.
- Montano, S., Reimer, J.D., Ivanenko, V.N., García-Hernández, J.E., van Moorsel, G.W.N.M., Galli, P. and Hoeksema, B.W., 2020. Widespread occurrence of a rarely known association between the hydrocorals *Stylaster roseus* and *Millepora alicornis* at Bonaire, southern Caribbean. *Diversity* 12, 218.
- Morard, R., Escarguel, G., Weiner, A.K., André, A., Douady, C.J., Wade, C.M., Darling, K.F., Ujié, Y., Sears, H.A., Quillévé, F., de Garidel-Thoron, T., de Vargas, C. and Kucera, M., 2016.

- Nomenclature for the nameless: a proposal for an integrative molecular taxonomy of cryptic diversity exemplified by planktonic Foraminifera. *Syst. Biol.* 65, 925–940.
- Munro, C., Siebert, S., Zapata, F., Howison, M., Damian-Serrano, A., Church, S.H., Goetz, F.E., Pugh, P.R., Haddock, S.H.D. and Dunn, C.W., 2018. Improved phylogenetic resolution within Siphonophora (Cnidaria) with implications for trait evolution. *Mol. Phylogenet. Evol.* 127, 823–833.
- Nawrocki, A.M., Schuchert, P. and Cartwright, P., 2010. Phylogenetics and evolution of Capitata (Cnidaria: Hydrozoa), and the systematics of Corynidae. *Zool. Scr.* 39, 290–304.
- Nixon, K.C., 1999. The parsimony ratchet, a new method for rapid parsimony analysis. *Cladistics* 15, 407–414.
- Osman, R.W. and Haugness, J.A., 1981. Mutualism among sessile invertebrates: a mediator of competition and predation. *Science* 211, 846–848.
- Pagel, M., 1994. Detecting correlated evolution on phylogenies: a general method for the comparative analysis of discrete characters. *Proc. R. Soc. B Biol. Sci.* 255, 37–45.
- Pantos, O. and Hoegh-Guldberg, O., 2011. Shared skeletal support in a coral-hyroid symbiosis. *PLoS One* 6, e20946.
- Peña Cantero, A.L., Boero, F. and Piraino, S., 2013. Shallow-water benthic hydroids from Tethys Bay (Terra Nova Bay, Ross Sea, Antarctica). *Polar Biol.* 36, 731–753.
- Petersen, K.W., 1990. Evolution and taxonomy in capitate hydroids and medusae (Cnidaria: Hydrozoa). *Zool. J. Linn. Soc.* 100, 101–231.
- Pica, D., Bastari, A., Vaga, C.F., Di Camillo, C.G., Montano, S. and Puce, S., 2017. Hydroid diversity of Eilat Bay with the description of a new *Zanclaea* species. *Mar. Biol. Res.* 13, 469–479.
- Picard, J., 1957. Étude sur les hydroïdes de la superfamille Pteronematoidea, I. Généralités. *Bull. Inst. Océanogr.* 1106, 1–12.
- Piraino, S., Bouillon, J. and Boero, F., 1992. *Halocoryne epizoica* (Cnidaria, Hydrozoa), a hydroid that “bites”. *Sci. Mar.* 56, 141–147.
- Postaire, B., Magalon, H., Bourmaud, C.A.F. and Bruggemann, J.H., 2016. Molecular species delimitation methods and population genetics data reveal extensive lineage diversity and cryptic species in Aglaopheniidae (Hydrozoa). *Mol. Phylogenet. Evol.* 105, 36–49.
- Postaire, B., Gélin, P., Bruggemann, J.H. and Magalon, H., 2017. One species for one island? Unexpected diversity and weak connectivity in a widely distributed tropical hydrozoan. *Heredity* 118, 385–394.
- Potkamp, G., Vermeij, M.J.A. and Hoeksema, B.W., 2017. Genetic and morphological variation in corallivorous snails (*Coralliophila* spp.) living on different host corals at Curaçao, southern Caribbean. *Contrib. Zool.* 86, 111–144.
- Puce, S., Arillo, A., Cerrano, C., Romagnoli, R. and Bavestrello, G., 2004. Description and ecology of *Cytaeis capitata* n. sp. (Hydrozoa, Cytaeidae) from Bunaken Marine Park (North Sulawesi, Indonesia). *Hydrobiologia* 530, 503–511.
- Puce, S., Calcinaï, B., Bavestrello, G., Cerrano, C., Gravili, C. and Boero, F., 2005. Hydrozoa (Cnidaria) symbiotic with Porifera: a review. *Mar. Ecol.* 26, 73–81.
- Puce, S., Cerrano, C., Boyer, M., Ferretti, C. and Bavestrello, G., 2002. *Zanclaea* (Cnidaria: Hydrozoa) species from Bunaken Marine Park (Sulawesi Sea, Indonesia). *J. Mar. Biol. Assoc. UK* 82, 943–954.
- Puce, S., Cerrano, C., Di Camillo, C.G. and Bavestrello, G., 2008. Hydroidomedusae (Cnidaria: Hydrozoa) symbiotic radiation. *J. Mar. Biol. Assoc. UK* 88, 1715–1721.
- R Core Team, 2020. R: A Language and Environment for Statistical Computing. R Foundation for Statistical Computing, Vienna, Austria.
- Rambaut, A., Suchard, M.A., Xie, D. and Drummond, A.J., 2014. Tracer v1.6. <https://beast.bio.ed.ac.uk/Tracer/>.
- Revell, L.J., 2012. Phytools: an R package for phylogenetic comparative biology (and other things). *Methods Ecol. Evol.* 3, 217–223.
- Ronowicz, M., Włodarska-Kowalczyk, M. and Kukliński, P., 2013. Hydroid epifaunal communities in Arctic coastal waters (Svalbard): effects of substrate characteristics. *Polar Biol.* 36, 705–718.
- Schneider, C.A., Rasband, W.S. and Eliceiri, K.W., 2012. NIH image to ImageJ: 25 years of image analysis. *Nat. Methods* 9, 671–675.
- Schuchert, P., 1996. The marine fauna of New Zealand: athecate hydroids and their medusae (Cnidaria: Hydrozoa). *N. Zeal. Oceanogr. Inst. Mem.* 106, 1–159.
- Schuchert, P., 2001. Survey of the family Corynidae (Cnidaria, Hydrozoa). *Rev. Suisse Zool.* 108, 739–878.
- Schuchert, P., 2010. The European athecate hydroids and their medusae (Hydrozoa, Cnidaria): Capitata part 2. *Rev. Suisse Zool.* 117, 337–555.
- Schuchert, P., 2023. World Hydrozoa Database. Available at: <https://www.marinespecies.org/hydrozoa> (accessed 4 April 2023).
- Schuchert, P. and Collins, R., 2021. Hydromedusae observed during night dives in the Gulf Stream. *Rev. Suisse Zool.* 128, 237–356.
- Stamatakis, A., 2014. RAxML version 8: a tool for phylogenetic analysis and post-analysis of large phylogenies. *Bioinformatics* 30, 1312–1313.
- Talavera, G. and Castresana, J., 2007. Improvement of phylogenies after removing divergent and ambiguously aligned blocks from protein sequence alignments. *Syst. Biol.* 56, 564–577.
- Tautz, D., Arctander, P., Minelli, A., Thomas, R.H. and Vogler, A.P., 2003. A plea for DNA taxonomy. *Trends Ecol. Evol.* 18, 70–74.
- Tödter, L., Worsaae, K. and Schmidt-Rhaesa, A., 2023. Comparative molecular and morphological species delineation of *Halammohydra* Remane, 1927 (Hydrozoa)—with the description of four new species. *Org. Divers. Evol.* 23, 455–476.
- Toshino, S., Tanimoto, M. and Minemizu, R., 2019. *Olinidias deigo* sp. nov., a new species (Hydrozoa, Trachylinae, Limnomedusae) from the Ryukyu archipelago, southern Japan. *ZooKeys* 900, 1–21.
- Travert, M., Boohar, R., Sanders, S.M., Boosten, M., Leclère, L., Steele, R.E. and Cartwright, P., 2023. Coevolution of the *Tlx* homeobox gene with medusa development (Cnidaria: Medusozoa). *Commun. Biol.* 6, 709.
- Tsang, L.M., Chu, K.H., Nozawa, Y. and Chan, B.K.K., 2014. Morphological and host specificity evolution in coral symbiont barnacles (Balanomorpha: Pyrgomatidae) inferred from a multi-locus phylogeny. *Mol. Phylogenet. Evol.* 77, 11–22.
- Uchida, T. and Sugiura, Y., 1976. On a hydromedusa, *Zanclaea prolifera* n. sp., of which the medusa gives rise to medusa-buds. *Proc. Jpn. Acad.* 52, 141–144.
- Vervoort, W., 2006. Leptolida (Cnidaria: Hydrozoa) collected during the CANCAP and Mauritania-II expeditions of the National Museum of Natural History, Leiden, The Netherlands [Anthoathecata, various families of Leptothecata and addenda]. *Zool. Meded.* 80, 181–318.
- Wickham, H., 2009. ggplot2: Elegant Graphics for Data Analysis. Springer-Verlag, New York, USA.
- WoRMS Editorial Board, 2023. World Register of Marine Species. Available at: <https://www.marinespecies.org> (accessed 4 April 2023).

Supporting Information

Additional supporting information may be found online in the Supporting Information section at the end of the article.

Table S1. List of the samples included in the analysis with associated data on the sampled life stage, substrate, sampling locality and coordinates, GenBank accession numbers, and whether they were included in

the Capitata analyses. Newly deposited sequences are in bold.

Table S2. Length of each single-locus and concatenated dataset used for the Capitata phylogenetic reconstructions, before and after the Gblocks treatment.

Table S3. Morphological and ecological character state for all species. States in brackets refer to the recoding to make character states binary for correlation analyses. 0, absence; 1, presence; g, generalist; b, bryozoan; c, scleractinian coral; o, octocoral; s, sponge; m, mollusc; ma, medusa; md, medusoid; sp, sporosac; st, stolonial; er, erect; so, solitary (vs. colonial); pe, pelagic; tr, tropical; nt, nontropical; wd, both tropical and nontropical; ol?, unknown.

Table S4. Pairwise average genetic distances within and between species belonging to *Zanclaea*, *Apatizanclaea* and *Halocoryne* calculated as % uncorrected *p*-distances. Interspecific distances are reported in the lower left portions, whereas standard deviations in the upper right portions; intraspecific distances and relative standard deviations are reported along the diagonal.

Table S5. Posterior probabilities for ancestral character states reconstructed at each node, for all examined characters. Node numbers refer to Fig. S1.

Figure S1. Bayesian phylogenetic hypothesis of the Capitata showing the node numbers to which Table S1 refers.