



A simplified constitutive model for a SEBS gel muscle simulant - Development and experimental validation for finite elements simulations of handgun and rifle ballistic impacts

Riccardo Andreotti

Callens® AREA3, Via Merini 37 21100 Varese, Italy

Dipartimento di Meccanica, Politecnico di Milano, via La Masa 1, 20156 Milano, Italy

riccardo.andreotti@callens.it

Valentina Leggeri

Fiocchi Munizioni SPA, Via Santa Barbara 4, 23900 Lecco, Italy

v.leggeri@fiocchi.com

Andrea Casaroli

Dipartimento di Meccanica, Politecnico di Milano, via La Masa 1, 20156 Milano, Italy

andrea.casaroli@polimi.it

Mauro Quercia

Callens® AREA3, Via Merini 37 21100 Varese, Italy

mauro.quercia@area3.it

Cristian Bettin

Bettin Engineering, Via Respighi 13, 35132 Padova, Italy

cristian@ingbettin.it

Mauro Zanella

Sunnen Italia Srl, Via Marconi 24-B, 20044 Arese (MI), Italy

m.t.zanella@gmail.com

Marco V. Boniardi

Dipartimento di Meccanica, Politecnico di Milano, via La Masa 1, 20156 Milano, Italy

marco.boniardi@polimi.it

ABSTRACT. An original simplified constitutive model is proposed to simulate the effects of ballistic impacts on blocks of synthetic muscle simulant based on mineral oil and styrene ethylene-butylene styrene polymers (SEBS) as a convenient substitute for Fackler ballistic gelatin. The model is based on a quasi-static elastic-plastic model associated with hydrodynamic properties regulated by a polynomial equation of state. The paper illustrates the development and experimental validation of the model to simulate 9x21mm full metal jacket (FMJ) round-nose, 7.62x39 mm FMJ and 5.56x45 mm NATO bullets penetrating 145x145x400 mm gel blocks. All material parameters are provided to be implemented in built-in LS-Dyna keywords.



Citation: Andreotti R., Leggeri V., Casaroli A., Quercia M., Bettin C., Zanella M., Boniardi M.V., A simplified constitutive model for a SEBS gel muscle simulant - Development and experimental validation for finite elements simulations of handgun and rifle ballistic impacts, 61 (2022) 176-197.

Received: 31.03.2022

Accepted: 28.04.2022

Online first: 07.05.2022



The validation confirms the effectiveness of the model and suggests possible further developments. The work also confirms the tested synthetic gel as a valid and convenient substitute for Fackler 10% ballistic gelatin at 4 °C.

KEYWORDS. wound ballistics; SEBS gel; synthetic muscle simulant; Fackler gelatin; finite element simulation; explicit solver.

Published: 01.07.2022

Copyright: © 2022 This is an open access article under the terms of the CC-BY 4.0, which permits unrestricted use, distribution, and reproduction in any medium, provided the original author and source are credited.

INTRODUCTION

The expression *muscle simulant* identifies those materials which are used to conduct experimental activities to investigate the response of animal or human tissues to specific mechanical phenomena. The typical engineering field of application of experimental activities involving the use of muscle simulants is *wound ballistics* [1] i.e. the investigation of the effects of ballistic impacts on human body. Another typical field of application in which muscle simulants are used is bird-strike assessment of aerospace structures, in which case muscle simulant blocks are used as standardized impactors to be representative of the heterogeneous mass of biological tissues that constitute a generic *bird*, impacting on the airframe structures to be assessed [2].

Muscle simulants are therefore used to allow researchers to overcome some issues directly related to the nature of real biological tissues. Those issues are mainly due to the impossibility of conducting repeatable experiments. This is related to the intrinsic heterogeneous nature of biological materials, their short durability, wide variability of their physical properties overtime and with temperature, the geometrical variability of the available samples and the difficulty of managing and preserving the samples overtime.

One of the most common muscle simulants is the so-called *ballistic gelatin*, which consists in a homogeneous material derived from collagen, which is a structural protein of connective tissues. To obtain gelatin, the collagen contained in animal tissues is hydrolyzed and transformed into smaller peptides (short chains between amino acids). The calibrated ballistic gelatin guarantees the possibility of producing homogeneous samples with controlled mechanical properties, allowing the researchers to conduct reproducible tests under fully controlled conditions. The biological nature of this material, however, causes it to be highly susceptible to temperature, therefore gelatin blocks must be stored refrigerated until the exact time of the tests. This makes all the experimental activities involving ballistic gelatin to be difficult to manage and therefore expensive, particularly so for activities to be necessarily conducted in field, where refrigerating large volumes of material can be very challenging or any time the experimental setup time and room temperature are such that the gelatin blocks encounter a serious thermal deconditioning.

To overcome the intrinsic difficulties and managing cost due to the biological nature of the ballistic gelatin, synthetic formulations of muscle simulant has been developed and tested in the last decades. The most promising formulation is based on a mixture of mineral oil and styrene ethylene-butylene styrene polymers (*SEBS*) in variable proportion, depending on the desired strength and work temperature. The synthetic formulation of these ballistic gels offers several strong advantages: ease of store, no need of refrigeration, potentially unlimited life and reusability and full transparency. Its properties can be calibrated to be comparable with standard Fackler or Nato ballistic gelatins, but these materials are not yet used for official applications due to lack of literature and experimental validation. In the last decade some studies have already been conducted to investigate the suitability of synthetic gels based on SEBS for terminal ballistics purposes. The dynamic back face (DBF) deformation of protection samples has been investigated in 2010 by Mauzac et al, using SEBS gel blocks as an alternative to NATO standard 20% gelatin [3]. Their results demonstrated the ease and convenience of use and the correct reproducibility of the tests even from different production batches, after several reuse cycles of the material. They however observed a significant difference in the DBF results obtained with 20% gelatin, suggesting the need of more accurate tuning of the strength of the synthetic gel to match the performances of the standard 20% NATO gelatin. In 2015 Mrozek et al [4] investigated the relationship between the mechanical properties of different formulations of SEBS gels with the penetration of steel spheres shot by a gas gun at various velocity, demonstrating that even though the ballistic impacts are high strain-rate phenomena, the penetration of the projectiles is mostly dependent on quasi-static mechanical properties such as shear modulus and toughness, due to the low glass transition temperature of these materials. In 2017 Bracq et al. [5] experimentally investigated the effects of strain-rate on a 30% SEBS gel formulation showing that the effects of strain-rate appear to be significant at very high strain-rates and high strain values, while at low and medium rates the dependency is low. In 2018 Bracq et al. [6] proposed a visco-hyperelastic constitutive law, validated to simulate blunt impacts of 140 grams cylindrical projectiles hitting gel blocks at maximum velocity of 30 m/s, thanks to a dedicated user-defined material subroutine developed to be used with Radioss solver. In 2020 an alternative modelling approach was proposed by Shen et

al. [7] validated on the same set of experimental data, for maximum impact speed of 30 m/s, showing anyway a progressive reduction in accuracy at increasing impact velocity.

In this context, we propose a novel simplified constitutive model to simulate the behavior of SEBS gel used as muscle simulant for terminal ballistics applications. The model has been validated to simulate the effects of commonly used handgun and rifle bullets therefore on a wide range of penetrations velocity. Scope of the study is to allow researchers in the field of wound ballistics, ballistic protections, and bird-strike assessment to have access to a representative finite element model to predict the behavior of SEBS gel without the need of complex and expensive experimental activities at specimen level. The experimental dataset provided for the validation of the model is also intended to be useful for researchers who conduct experimentations on biological ballistic gelatin to compare the effects of similar bullets and evaluate the possibility to switch to SEBS gel, eventually taking advantage of the much lower cost and time of experimental activities.

The first section describes the experimental setup, the second section introduces the development of the constitutive model of the SEBS gel. The third section shows the simulation setup. Both experimental and numerical results are collected in the fourth section to allow a clear comparison and validation of the model. In the fifth section we resume the outcomes of the study and in the last section we collect the conclusions and introduce possible further developments.

EXPERIMENTAL TESTS

The experimental ballistic tests were conducted on 145x145x400 mm blocks of synthetic muscle simulant with the aim of collecting data about the interaction between impactor and target in terms of bullet kinematics and temporary cavity evolution. To catch the response of the blocks at different velocities and different bullet shapes the experimentation involved the impacts of three different ammunitions, spanning the typical range of portable firearms from handgun to assault rifles, with impact velocities from 360 to 922 m/s. Two replicates were conducted for each type of cartridge.

Test procedures

The ballistic tests were conducted at an outdoor practice shooting range with ambient temperatures ranging from 24 to 27 Celsius degree. Until test time the blocks were stored at ambient temperature without exposition to direct sunlight. The blocks under test were positioned on a wooden shelf (Fig. 1). The shots were fired approximately 4 m far from the target (Fig. 2). The acquisition of the bullets and cavity kinematics was performed thanks to a Phantom Veo high frame rate camera positioned sideways to the blocks, recording at 40000 frames per second. A checkered calibration marker was fixed to the side of the support shelf to allow easier distance measures on the acquired frames. An overview of the experimental setup is shown in (Fig. 2).

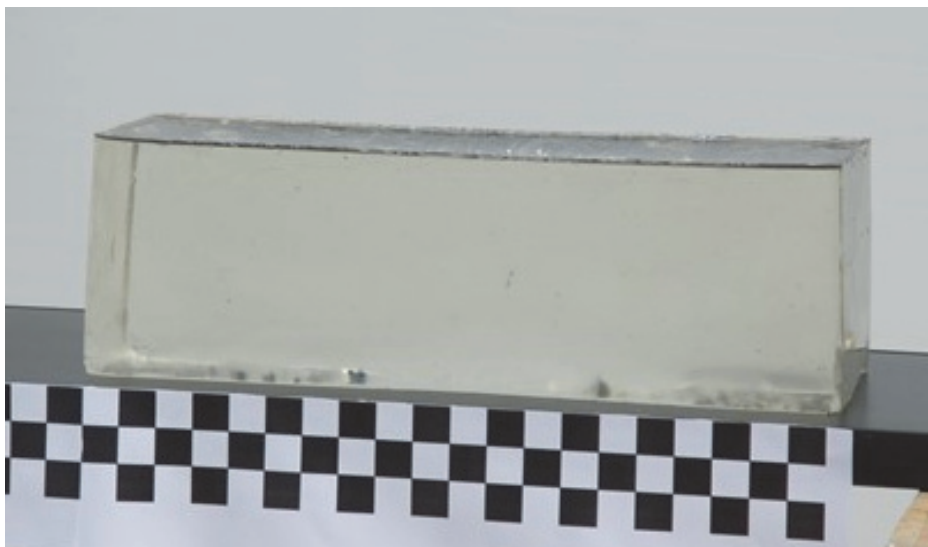

Figure 1: A block of synthetic muscle simulant positioned before the shot.



Figure 2: Overview of the in-field experimental setup. Shooting setup (left) and high frame-rate cameras setup (right).

Baligel

The tested blocks were formed with a synthetic gel based on a mixture of paraffin oil and styrene ethylene-butylene styrene polymers (*SEBS*) with a respective weight proportion of 83/17. This formulation, named *Baligel*, was identified by the producer of the blocks, Ing. Cristian Bettin, as a valid and practical alternative to the biological ballistic gelatin. Its ballistic performances were assessed by means of the Fackler and Malinowski method. The test consists in verifying the depth of penetration (DoP) of 4.5 mm steel spheres (called *BBs*) impacting at $180 (\pm 5)$ m/s. Eight tests were conducted at block temperatures ranging from 20 to 22 °C, resulting in DoP values ranging from 80mm to 87mm with an average DoP of 83mm. Those values are compatible with the standard calibrated Fackler 10% ballistic gelatin at 4 °C, which DoP values are allowed to stay in the range of $85 (\pm 5)$ mm to meet Fackler and Malinowski standard, and in the range of $85 (\pm 10)$ mm to meet the Federal Bureau of Investigation (FBI) protocol [8]. The *Baligel* formulation is therefore particularly convenient for in-field experimental activities, thanks to its strength at ambient temperatures and its clarity and transparency, allowing a proper high frame rate recording without artificial lights even in absence of direct sunlight (Fig. 3).



Figure 3: *Baligel* block showing its transparency and clarity.



Ammunitions and firearms

The blocks were tested under impacts of three types of bullets. 9x21 mm FMJ bullets (Fig. 4) were fired by means of a SIG Sauer P226 handgun. 7.62x39 mm FMJ bullets (Fig. 5) were shot by means of a Zastava M92 Yugo carabin. 5.56x45 mm NATO bullets (Fig. 6) were shot by means of a Colt M4 carabin. Tab. 1 summarizes the nominal data of the tested shots.

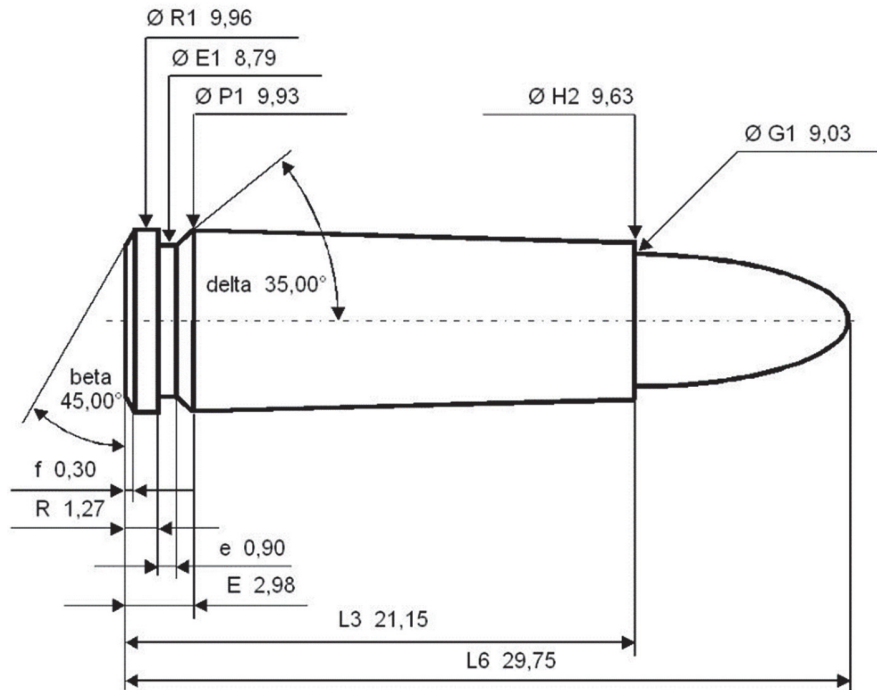

Figure 4: 9x21 mm FMJ cartridge. All sizes in mm (credits to Francis Flinch CC BY 3.0).

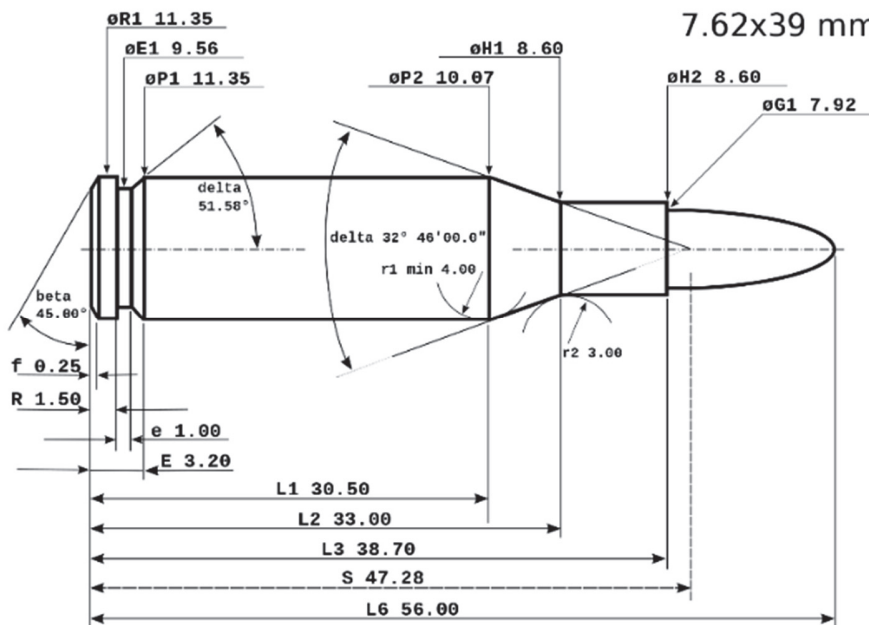

Figure 5: 7.62x39 mm FMJ cartridge. All sizes in mm (credits to Francis Flinch CC BY 3.0).

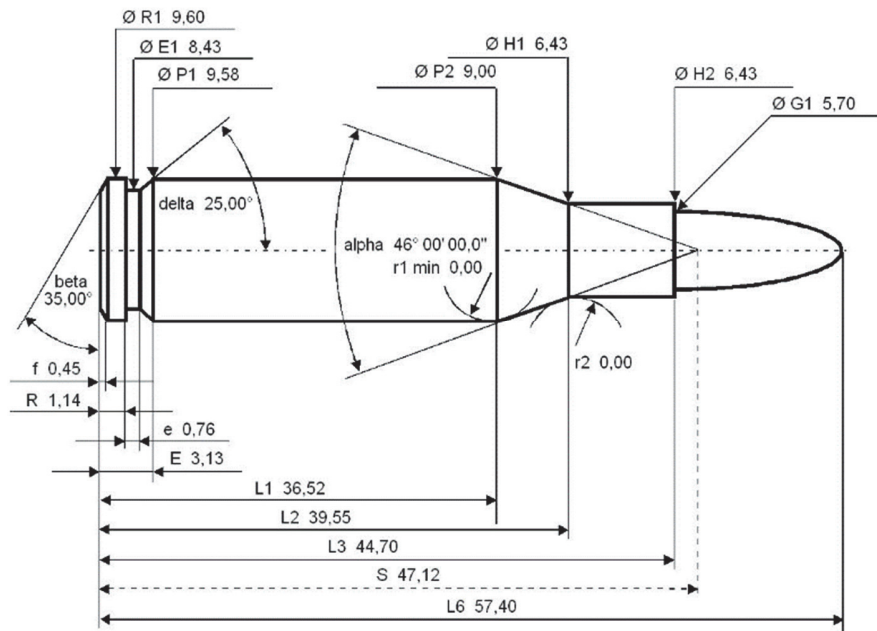

Figure 6: 5.56x45 mm NATO cartridge. All sizes in mm (credits to Francis Flinch CC BY 3.0).

Cartridge	Firearm	Bullet Mass [g]	Expected Muzzle Velocity [m/s]
9x21 mm FMJ round nose	SIG Sauer P226	8	360
7.62x39 mm FMJ	Zastava M92	8	710
5.56x45 mm NATO	Colt M4	4	922

Table 1: Summary of the nominal data of the tested bullets.

DEVELOPMENT OF A SIMPLIFIED CONSTITUTIVE LAW FOR A SEBS GEL

The mechanical behavior of SEBS gels subjected to dynamic loading is particularly complex, showing a hyper-viscoelastic behavior with rate effect being very significant at high strain rates and high strain values, as demonstrated by Bracq et al. (2017 [5], 2018 [6]). However, evidence shows that the macroscopic behavior of gel blocks impacted by 5.56 mm steel spheres at velocities ranging between 100 and 500 m/s is mostly influenced by the quasi-static mechanical properties, while the effects of rate-dependence are much less relevant in terms of impactor penetration and cavity formation (Mrozc et al. 2015 [4]). Therefore, to develop a practical and simplified finite element model to simulate the behavior of SEBS gel blocks without the need of expensive rate-dependence tests at specimen level, we propose an approach based on a quasi-static elastic-plastic behavior model associated with hydrodynamic properties. This approach already proved to be effective in modelling the behavior of 250x300x330 mm blocks made with Fackler 10% 4°C ballistic gelatin impacted by 4.8 mm steel spheres at velocities between 720 and 947 m/s (Wen et al. 2013[9]). That same model proved to be effective in predicting the effects of 7.62x39 bullets impacting on 300x300x300 mm block of Fackler gelatin impacted at 625 m/s (Wen et al. 2017 [10]).

The model of the SEBS gel *Baligel* was developed for the use with LS-Dyna solver without the need of creating user-defined material models or subroutines. The model was therefore defined in terms of parameters to be assigned to a build-in material type in LS-Dyna. The most convenient material type to implement a quasi-static elastic-plastic material with hydrodynamic properties within LS-Dyna solver-deck was identified to be *MAT_010/*MAT_ELASTIC_PLASTIC_HYDRO, associated with a polynomial equation of state *EOS_001/*EOS_LINEAR_POLYNOMIAL[11].

Baligel constitutive parameters

The density of *Baligel* was estimated as 860.2 kg/m³, based on the weight fraction of paraffin (850 kg/m³) and SEBS polymers (910 kg/m³). According to the calibration tests conducted on the *Baligel* blocks, the ballistic strength of *Baligel* at ambient



temperature is expected to be comparable to Fackler gelatin's at 4 °C. Moreover, according to Mrozek et al. (2015 [4]), the most important elastic parameter influencing the penetration of bullets in SEBS gel blocks is the shear modulus. The shear modulus was therefore calculated from the Young modulus (850kPa) and bulk modulus (2.38GPa) reported by Wen et al. (2013 [9]) for Fackler gelatin. The shear modulus implemented for *Baligel* was therefore 295.0kPa. The same criterion was followed for the tensile properties defining the toughness of the elastic-plastic material model, assumed to be equivalent to those proposed for Fackler gelatin by Wen et al. (2013 [9]). The yield stress was therefore set equal to 220kPa, the tangent modulus after yield was set to 10kPa, and the equivalent failure strain was set equal to 0.7.

The dilatational component of the constitutive law is regulated thanks to a polynomial equation of state (Eqn.1) [12]:

$$p = C_0 + C_1\mu + C_2\mu^2 + C_3\mu^3 \tag{1}$$

where p is the pressure, C_0 , C_1 , C_2 and C_3 are material constants and μ is a dimensionless parameter defined as:

$$\mu = \frac{\rho}{\rho_0} - 1 \tag{2}$$

where ρ is the mass density and ρ_0 is the initial mass density.

For small and moderate values of μ , the material constants in Eqn.1 are given in Eqn.(3) [13], where c_0 is bulk wave velocity, C_1 is the bulk modulus and $k=2.0$ is the Hugoniot constant parameter typical of biological soft materials [14], assumed to

$$\begin{aligned} C_0 &= 0 \\ C_1 &= \rho_0 c_0^2 \\ C_2 &= (2k - 1)C_1 \\ C_3 &= (k - 1)(3k - 1)C_1 \end{aligned} \tag{3}$$

be representative also for *Baligel*. The constants were then calculated by assuming the bulk modulus to be $C_1=1.66\text{GPa}$, a value typical for paraffin oil. Consequently, the dependent constants were calculated as $C_2=4.98\text{GPa}$ and $C_3=8.3\text{GPa}$.

FINITE ELEMENT SIMULATION OF THE BALLISTIC IMPACTS

The numerical simulations were conducted by means of the explicit finite element solver LS-Dyna. Gel blocks and bullets were modelled in solid elements. The blocks were modelled with fully integrated hexahedron elements with a mesh size of 1 mm constant along the axial direction Z; the cross size of the mesh is instead gradually increasing from the axis of the bullet to the periphery of the block's cross section. The elements directly impacted by the bullets have a size of 0.3 x 0.3 x 1 mm. This mesh size guarantees convergence of the results and is related to the failure strain value set in the gel material model [9,10]. To reduce the computational resources needed for the simulations and facilitate the analysis of the results, a symmetry plane boundary condition was imposed. Therefore, the bullet has just three free degrees of freedom in the simulations, while the real impacts cause the bullets' kinematics to involve all six degrees of freedom. To simulate the stiffness introduced by the support plane on which the blocks lie during the tests, no displacements are allowed to the nodes corresponding to the face of the block in contact with the support. The bullets were modelled in tetrahedral elements with element size 1.0 mm, associated with rigid body properties to represent the mass distribution of the real bullets (Fig. 8). The interaction between bullets and blocks is allowed by means of penalty contact.

Initial impact angle

The kinematics of the bullets during the interaction with the blocks is influenced by the initial angle of the impactors. The simulations with zero initial angle would end up with late deviation of trajectory compared to real impacts which are always affected by a significant initial angle due to the non-symmetric release of the bullets from the cartridge immediately after the shots. Available literature shows that for small caliber cartridges, the typical values of the total angle of the bullets' axis with respect to the tangent trajectory of their center of mass within 5 m from the muzzle is most likely comprised between one and five degrees [15,16]. Therefore, the simulations were conducted with initial angles in this range. No initial angular velocity was imposed to the impactors.

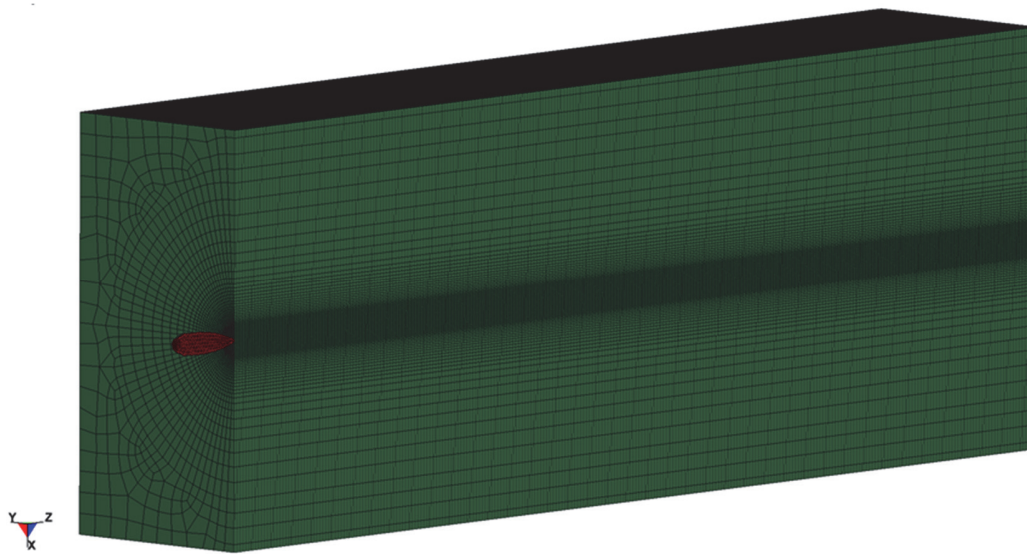

Figure 7: Finite element model of bullet and gel block.

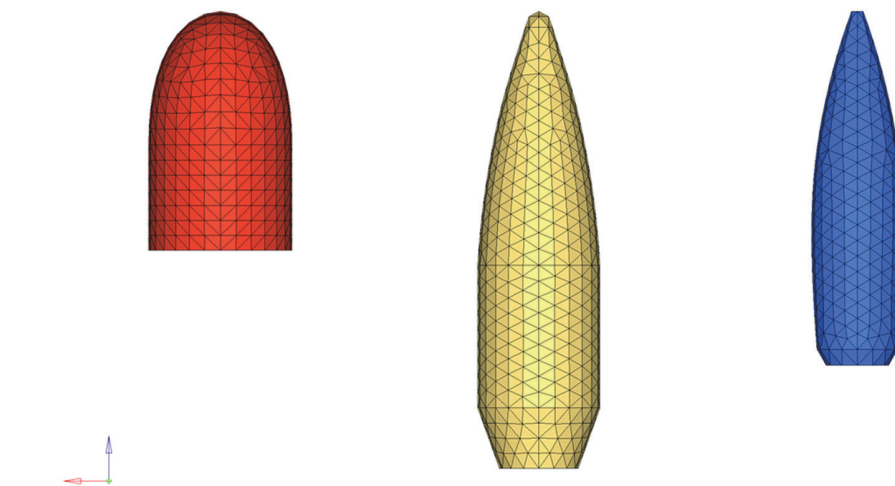

Figure 8: Finite element models of the bullets, left to right: 9x21mm FMJ round nose (red), 7.62x39mm FMJ (yellow), 5.6x45mm NATO (blue).

RESULTS AND VALIDATION

In the following, a comparison between experimental and numerical results is provided. All the numerical simulations were initialized with the measured bullet velocities and the estimated incidence angle.

Cartridge	Bullet Mass [g]	Measured Velocity [m/s]	Estimated Impact Angle [deg]
9x21 mm FMJ round nose	8	361	-1
7.62x39 mm FMJ	8	703	2
5.56x45 mm NATO	4	912	5

Table 2: Summary of the initial conditions.



9x21 mm FMJ round-nose

The comparison between real and simulated evolutions of the bullet's kinematics and the temporary cavity shows a good correspondence all along the block (Fig. 9 to Fig. 13 and Fig. 15). The main difference is a delay in the simulated penetration compared to reality, quantified in 0.4 ms when the bullet escapes the block (Fig. 16). The residual velocity of the real bullet is 171 m/s, while the simulated value is 96.7 m/s. Therefore, the kinetic energy absorbed by the *Baligel* block is 404 J in the real impact, while the simulation predicts an energy absorption of 484 J. Considering the 0.4 m length of the block, these mechanical work values correspond to an average penetration force of 1011 N in the real case and 1210 N estimated by the simulation. The maximum width of the temporary cavity is around 50 mm in both reality and simulation.

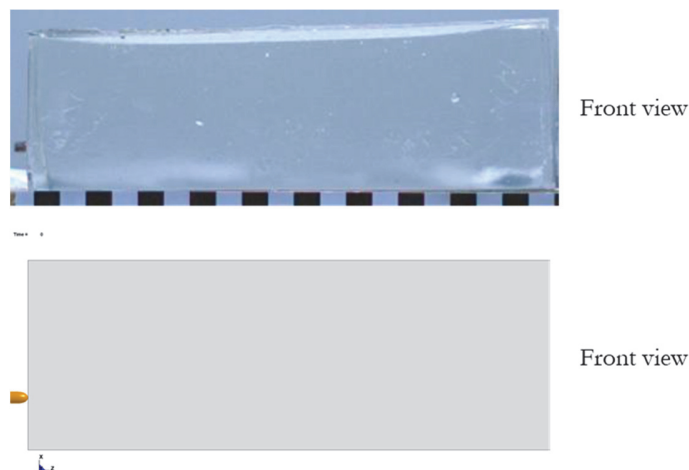

Figure 9: 9x21mm FMJ round nose impact. Comparison between experimental results (above) and simulation (below). Time = 0.0 ms. The resolution of the checkered ruler is 20 mm.

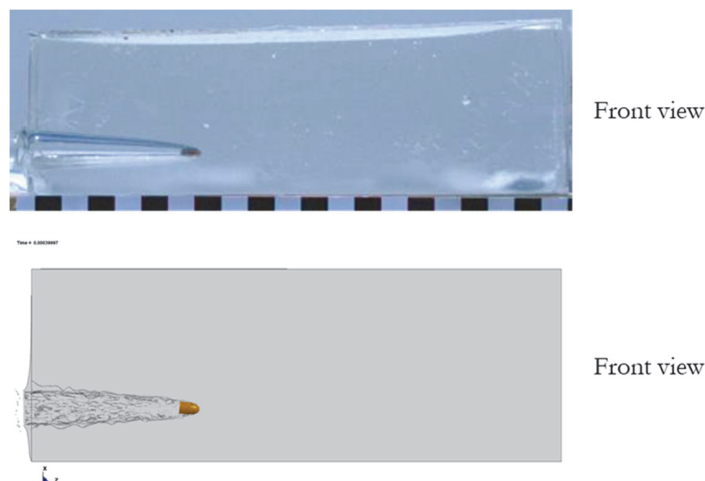

Figure 10: 9x21mm FMJ round nose impact. Comparison between experimental results (above) and simulation (below). Time = 0.4 ms. The resolution of the checkered ruler is 20 mm.

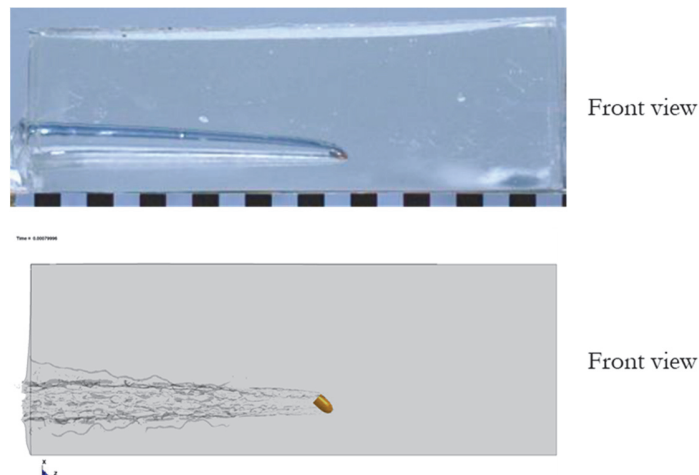

Figure 11: 9x21mm FMJ round nose impact. Comparison between experimental results (above) and simulation (below). Time = 0.8 ms. The resolution of the checkered ruler is 20 mm.

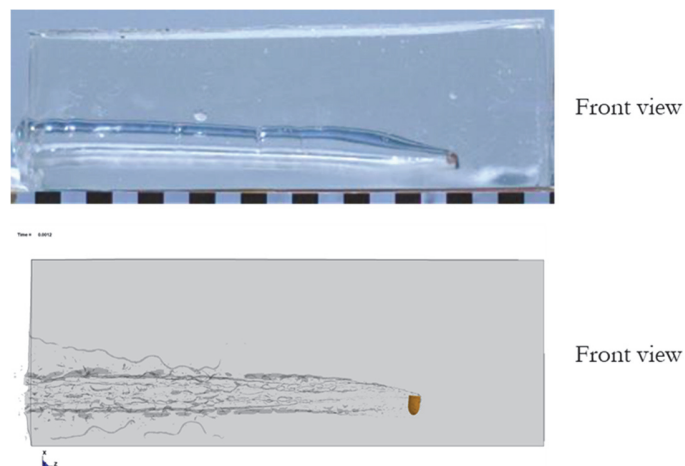

Figure 12: 9x21mm FMJ round nose impact. Comparison between experimental results (above) and simulation (below). Time = 1.2 ms. The resolution of the checkered ruler is 20 mm.

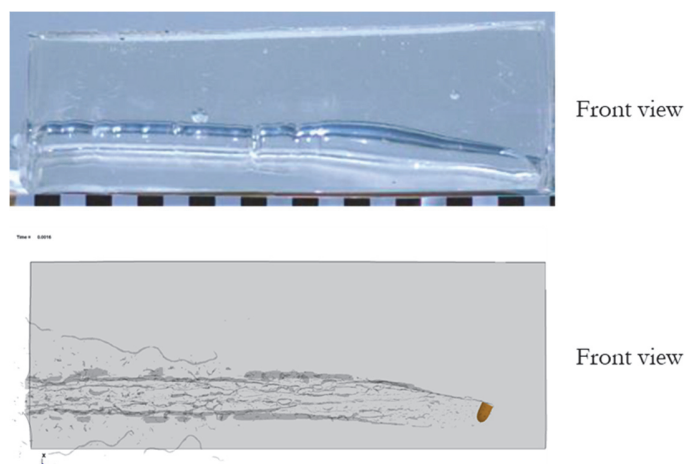

Figure 13: 9x21mm FMJ round nose impact. Comparison between experimental results (above) and simulation (below). Time = 1.6 ms. The resolution of the checkered ruler is 20 mm.

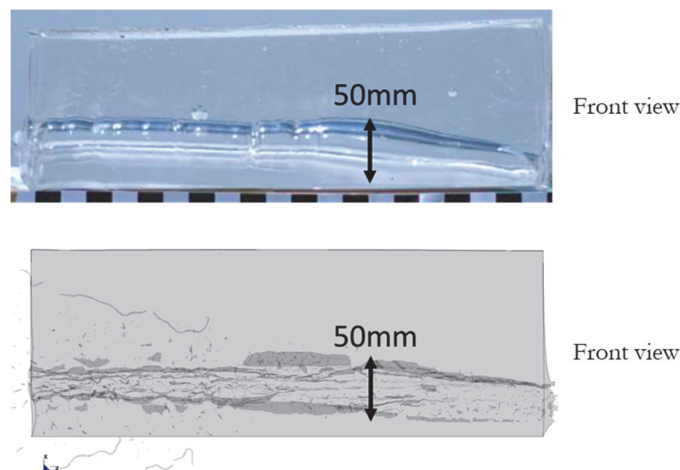

Figure 14: 9x21mm FMJ round nose impact. Comparison between maximum cavity width: experimental results (above) and simulation (below) at escape time. Time = 1.6 ms (above) and 2.1 ms (below). The resolution of the checkered ruler is 20 mm.

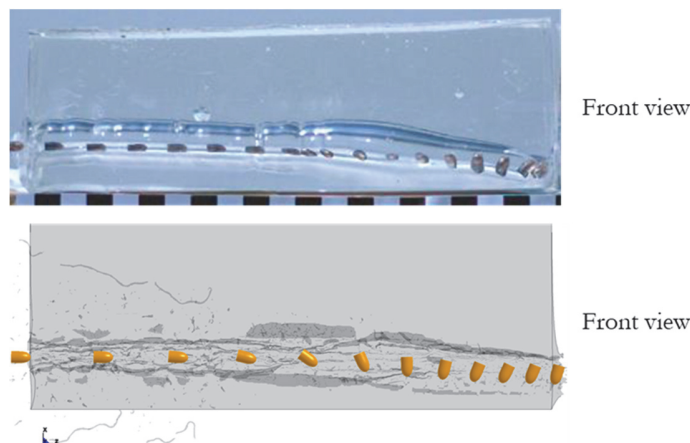

Figure 15: 9x21mm FMJ round nose impact. Comparison between experimental results (above) and simulation (below). Evolution of the bullet's kinematics during the penetration superimposed to the temporary cavity captured at escape time. The resolution of the checkered ruler is 20 mm.

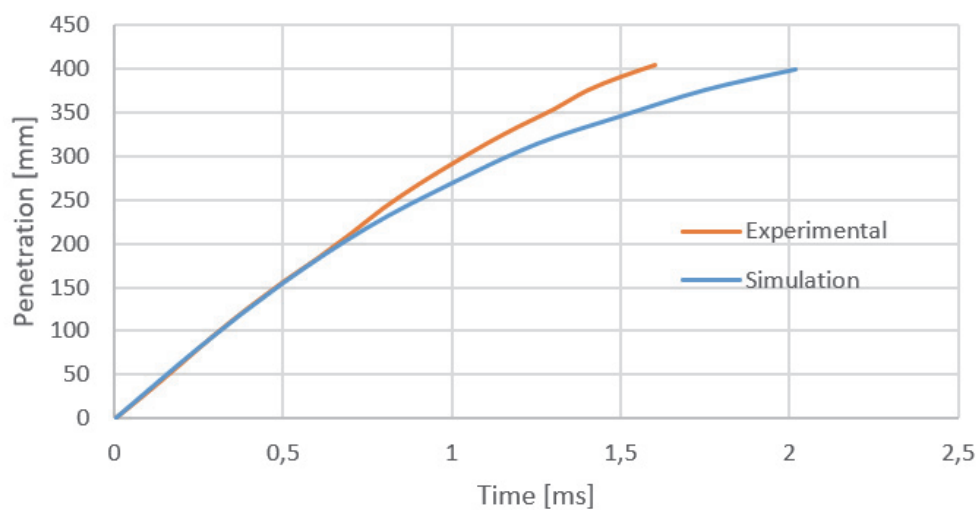

Figure 16: 9x21mm FMJ round-nose penetration as a function of time. Comparison between experimental results (red line) and simulation (blue line).



7.62x39 mm FMJ

The comparison between real and simulated evolutions of the bullet's kinematics and the temporary cavity shows a good correspondence all along the block (Fig. 17 to Fig. 24). The bullet's kinematics is very similar until around 0.4 ms, when the stall of the bullet at ninety degrees angle causes the divergence of the simulation with respect to the reality. The simulation predicts the bullet to continue its rotation and to penetrate the last third of the block rotated almost 180 degrees. The real evolution shows instead an extended phase of sideways penetration at around ninety degrees rotation and a late turning of the bullet reducing its angle and escaping the block at around forty-five-degree angle (Fig. 22). A slight delay of 0.1 ms affects the simulated penetration compared to reality when the bullet escapes the block. The residual velocity of the real bullet is 314 m/s, while the simulated value is 231 m/s. Therefore, the kinetic energy absorbed by the *Baligel* block is 1582 J in the real impact, while the simulation predicts an energy absorption of 1763 J. Considering the 0.4 m length of the block, these mechanical work values correspond to an average penetration force of 3956 N in the real case and 4408 N estimated by the simulation. The maximum observed width of the temporary cavity is around 135 mm in both reality and simulation even though real cavity could be not completely captured by the camera. It is worth noting anyway that the real cavity boundaries are difficult to identify from the captured frames due to the light refraction inside the bended gel block (Fig. 23).

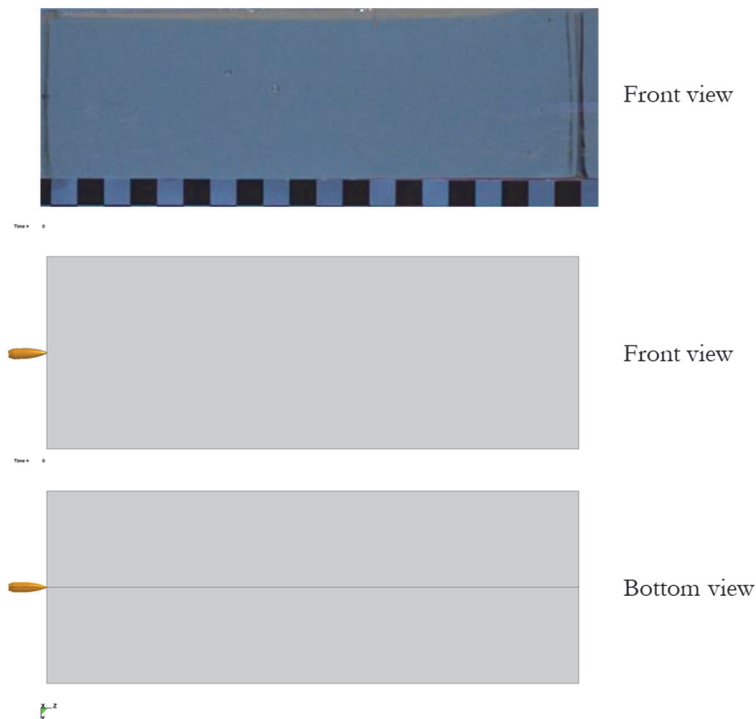

Figure 17: 7.62x39 mm FMJ impact. Comparison between experimental results (above) and simulation seen from the two cross directions (below). Time = 0.0 ms. The resolution of the checkered ruler is 20 mm.

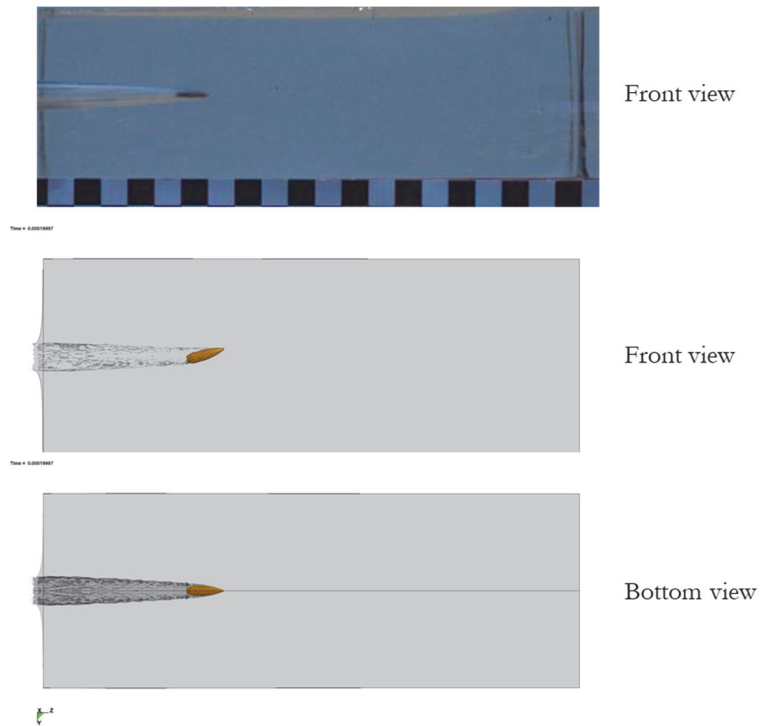

Figure 18: 7.62x39 mm FMJ impact. Comparison between experimental results (above) and simulation seen from the two cross directions (below). Time = 0.2 ms. The resolution of the checked ruler is 20 mm.

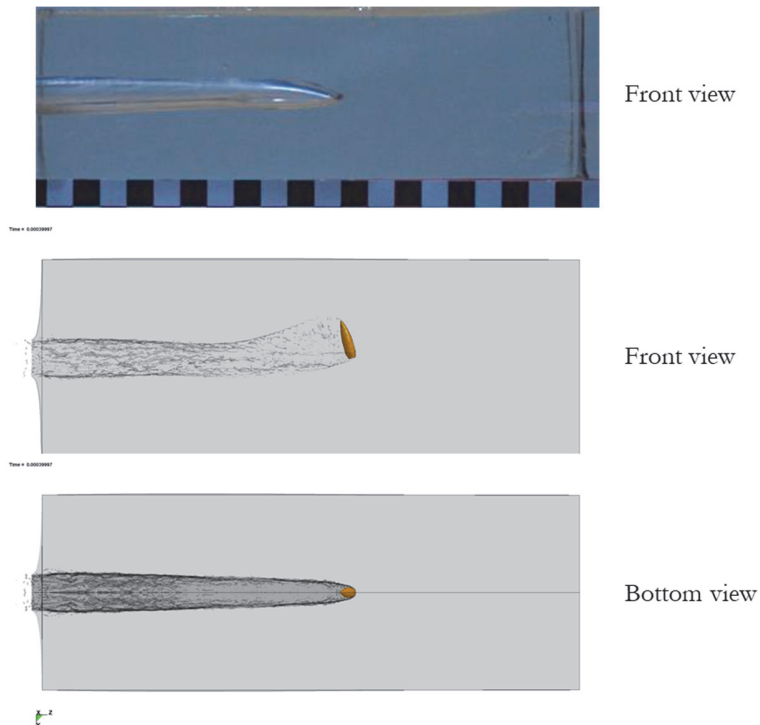

Figure 19: 7.62x39 mm FMJ impact. Comparison between experimental results (above) and simulation seen from the two cross directions (below). Time = 0.4 ms. The resolution of the checked ruler is 20 mm.

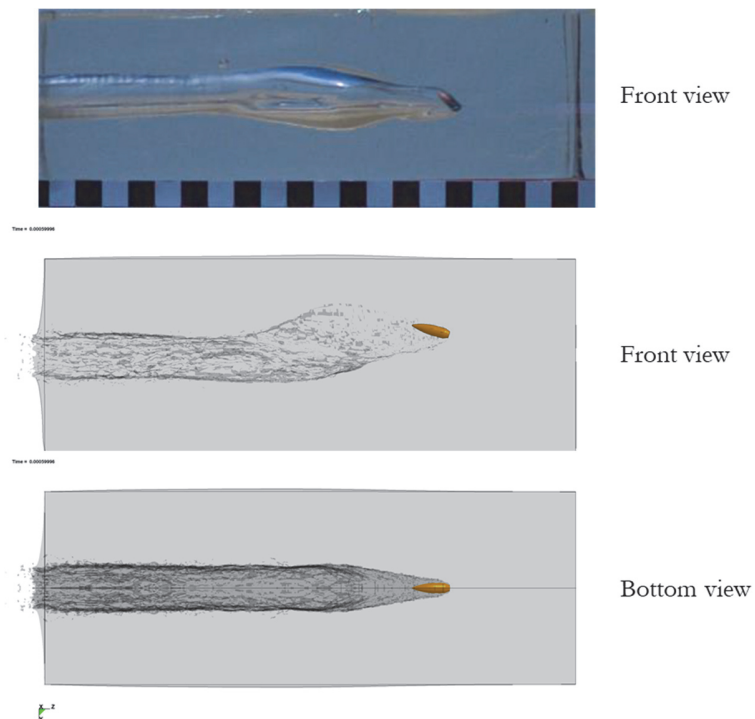

Figure 20: 7.62x39 mm FMJ impact. Comparison between experimental results (above) and simulation seen from the two cross directions (below). Time = 0.6 ms. The resolution of the checkered ruler is 20 mm.

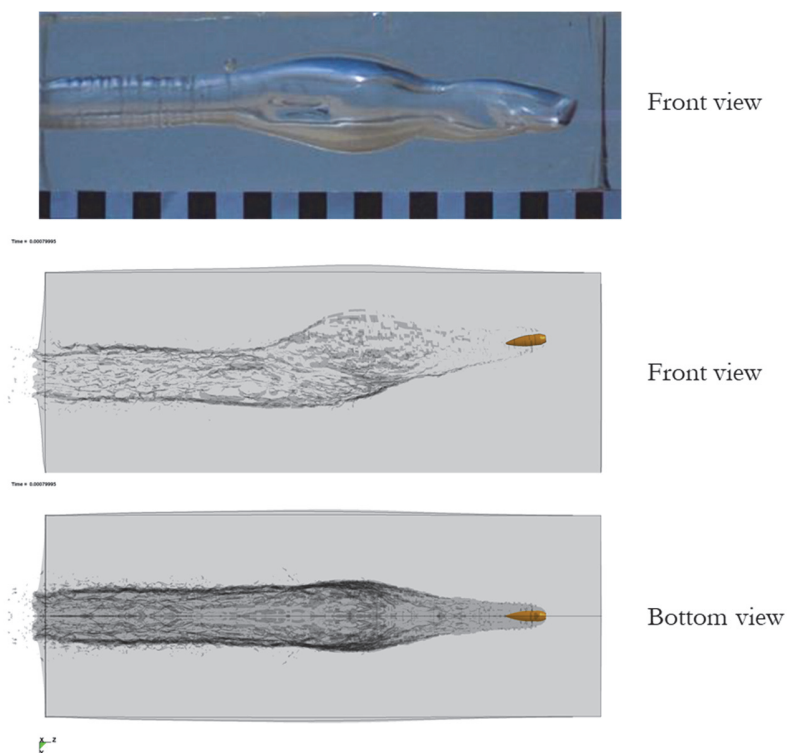

Figure 21: 7.62x39 mm FMJ impact. Comparison between experimental results (above) and simulation seen from the two cross directions (below). Time = 0.8 ms. The resolution of the checkered ruler is 20 mm.

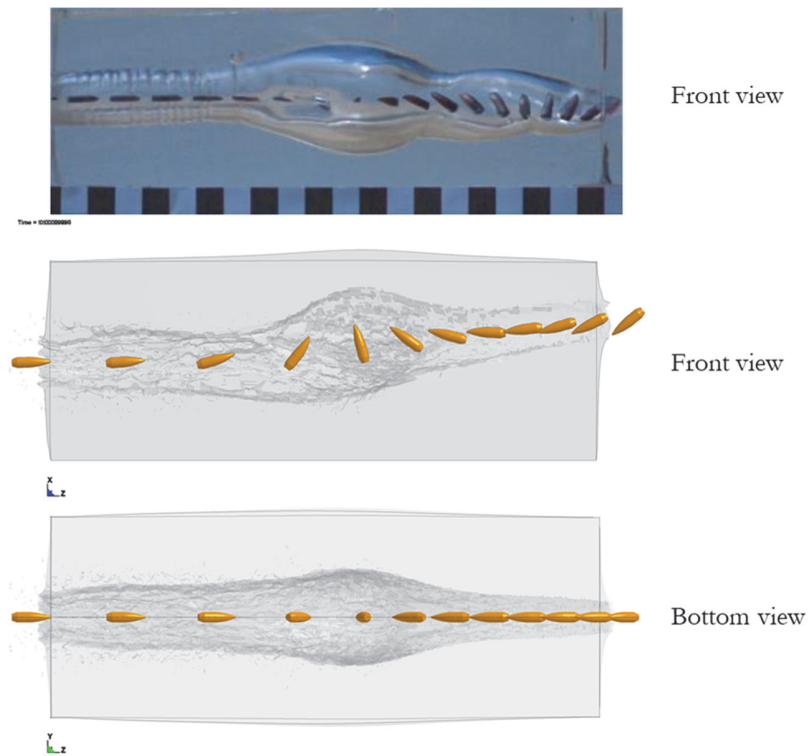

Figure 22: 7.62x39 mm FMJ impact. Temporary cavities at escape time: experimental results at time 0.9ms (above) compared to simulation results (below) at time 1.0ms, seen from the two cross directions. Evolution of the bullet's kinematics during the penetration superimposed to the temporary cavity captured at escape time. The resolution of the checkered ruler is 20 mm.

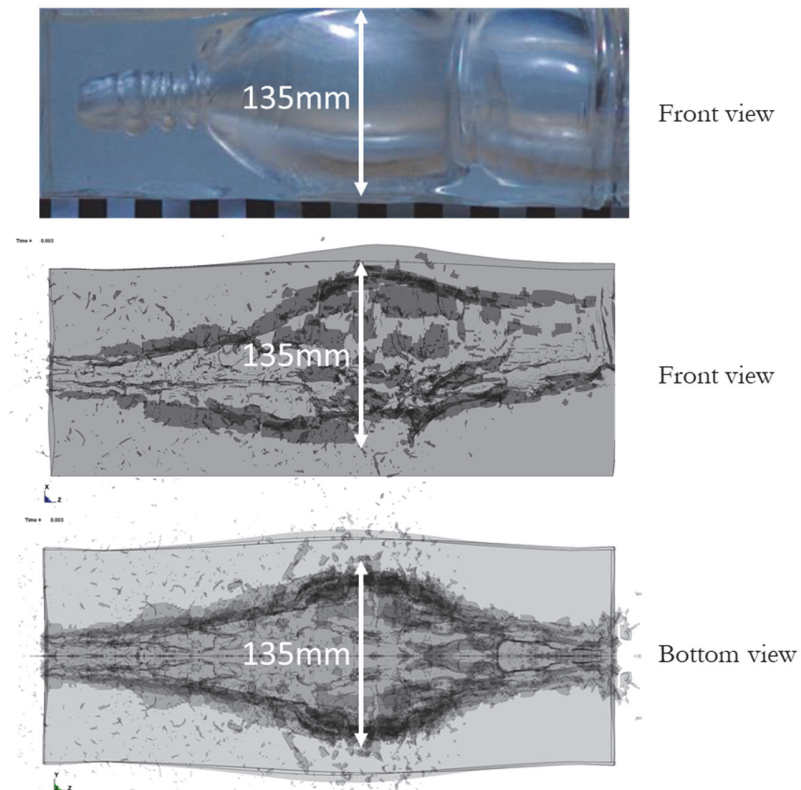

Figure 23: 7.62x39 mm FMJ impact. Maximum cavity width: experimental results (above) compared to simulation seen from the two cross directions (below). Time = 3.0 ms. The resolution of the checkered ruler is 20 mm.

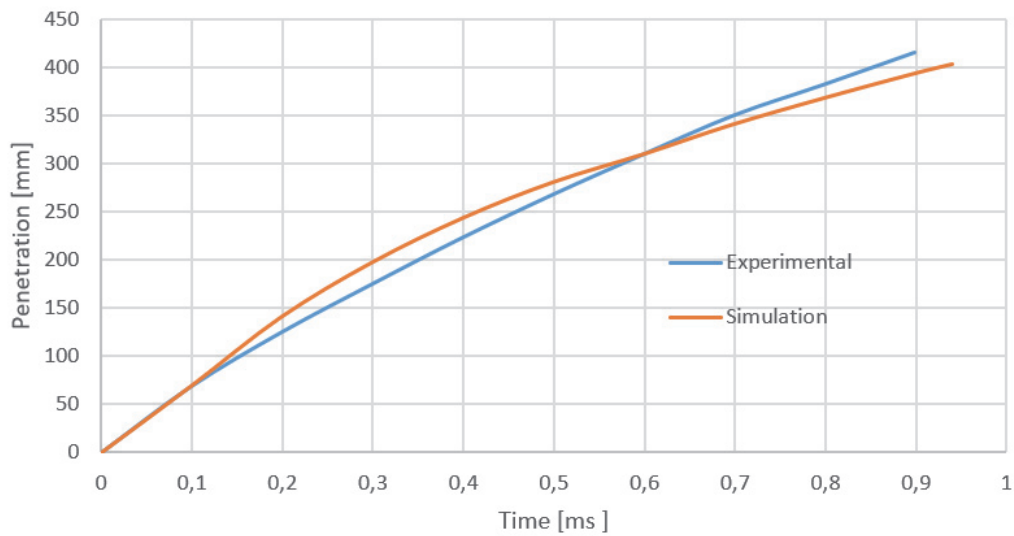

Figure 24: 7.62x39 mm FMJ penetration as a function of time. Comparison between experimental results (blue line) and simulation (red line).

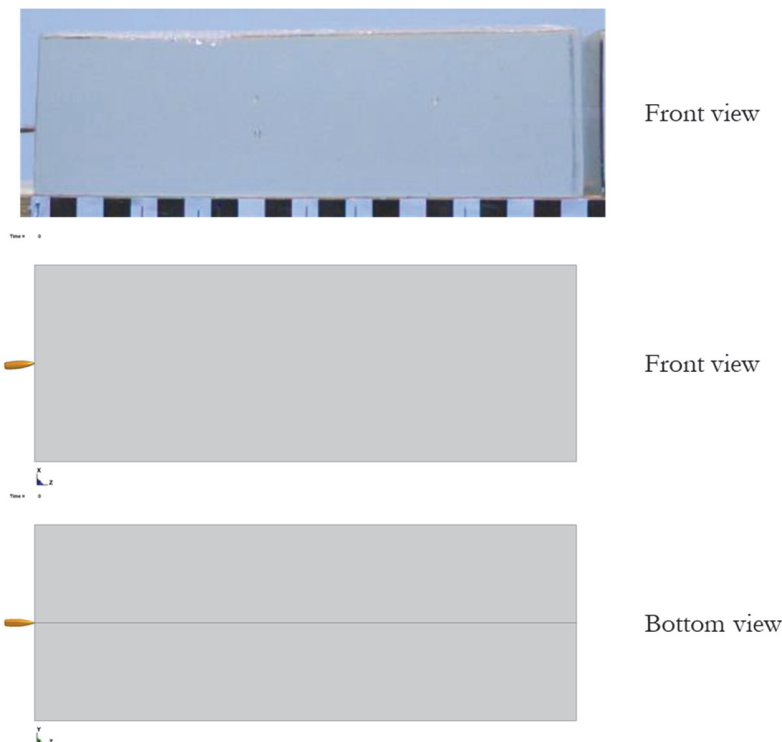

Figure 25: 5.56x45 mm NATO impact. Comparison between experimental results (above) and simulation seen from the two cross directions (below). Time = 0.0 ms. The resolution of the checkered ruler is 20 mm.

5.56x45 mm NATO

The comparison between real and simulated evolutions of the bullet's kinematics and the temporary cavity shows a good correspondence all along the block (Fig. 25 to Fig. 32). The bullet's rotation is almost identical until 0.4 ms. Then, the simulation predicts a continued rotation bringing the bullet to escape the block at around 270 degrees angle. The real rotation of the bullet seems instead to encounter a stall, it is however impossible to clearly identify the position of the real bullet at the escape. The simulation anticipates the escape of the bullet of about 0.2 ms compared to reality. The residual velocity of the real bullet is 152 m/s, while the simulated value is 199 m/s. Therefore, the kinetic energy absorbed by the *Baligel* block is 1617 J in the real impact, while the simulation predicts an energy absorption of 1584 J. Considering the 0.4 m length of

the block, these mechanical work values correspond to an average penetration force of 4043 N in the real case and 3961 N estimated by the simulation. The simulation appears to significantly underestimate the width of the temporary cavity during the penetration of the bullet (Fig. 30), but the subsequent maximum width of the temporary cavity is correctly predicted at around 128 mm. It is worth noting anyway that the real cavity boundaries are difficult to identify from the captured frames due to the light refraction inside the bended gel block (Fig. 31) therefore the measures reported should be considered useful only for comparison.

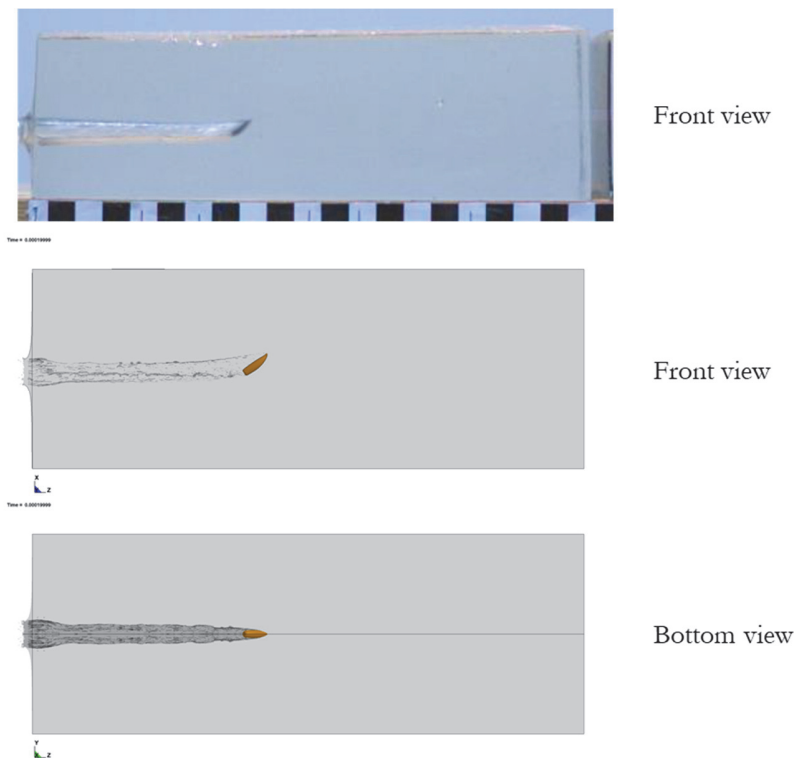

Figure 26: 5.56x45 mm NATO impact. Comparison between experimental results (above) and simulation seen from the two cross directions (below). Time = 0.2 ms. The resolution of the checkered ruler is 20 mm.

RESUME OF THE RESULTS

A simplified constitutive model has been developed to be used to simulate the behavior of synthetic SEBS gel *Baligel* under ballistic impacts. The toughness of the material was developed based on a constitutive model demonstrated representative of Fackler gelatin [9,10]. The dilatational behavior of the material was modeled by means of a polynomial equation of state whose parameters were calculated based on the paraffin oil compressibility and the Hugoniot constant parameter for biological tissues [12–14]. Experimental tests were put in place to capture the kinematics of the bullets and the subsequent development of the temporary cavity within the blocks during the penetration of 9x21 mm FMJ, 7.62x39 mm FMJ and 5.56x45 mm NATO bullets. This allowed to cross-validate the model on different calibers and impact velocities spanning the typical range of small caliber firearms. In general, the simulations show a good accuracy in terms of absorbed energy, with a tendency to overestimate the absorbed energy at lower penetration velocities and slightly underestimate the absorbed energy at higher penetration velocities (Tab. 3 and Fig. 33). This confirms the hypothesis of a limited importance of the rate-dependance on the macroscopic behavior of the blocks, but also highlights the role of viscous forces in the observed phenomena. Very good predictions in terms of width of the temporary cavity have been verified, even though difficulties have been encountered in estimating their exact extent due to the light refraction in the highly deformed blocks. The kinematics of the bullets showed good correspondence, with possible significant divergencies only in the final portion of the blocks.

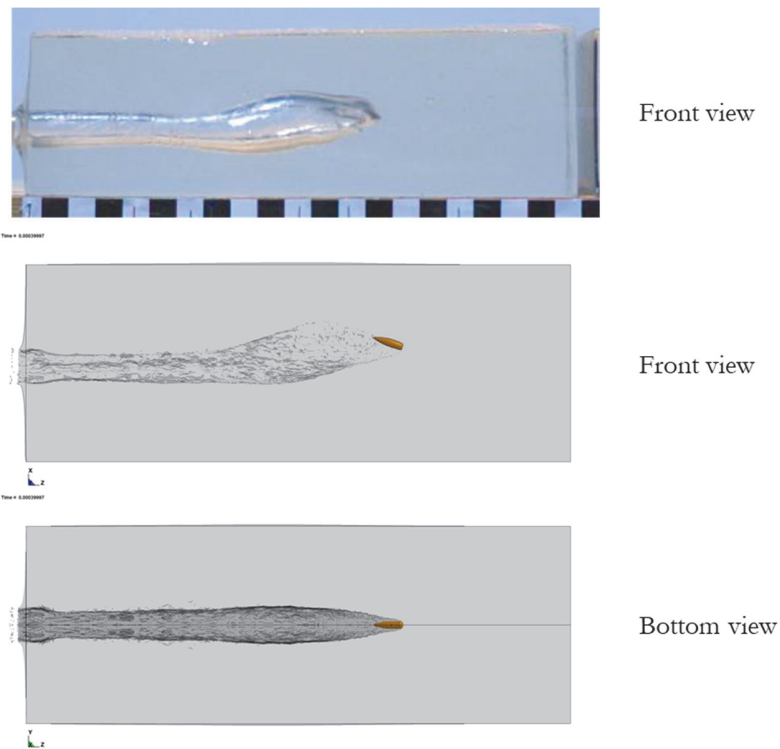

Figure 27: 5.56x45 mm NATO impact. Comparison between experimental results (above) and simulation seen from the two cross directions (below). Time = 0.4 ms. The resolution of the checkered ruler is 20 mm.

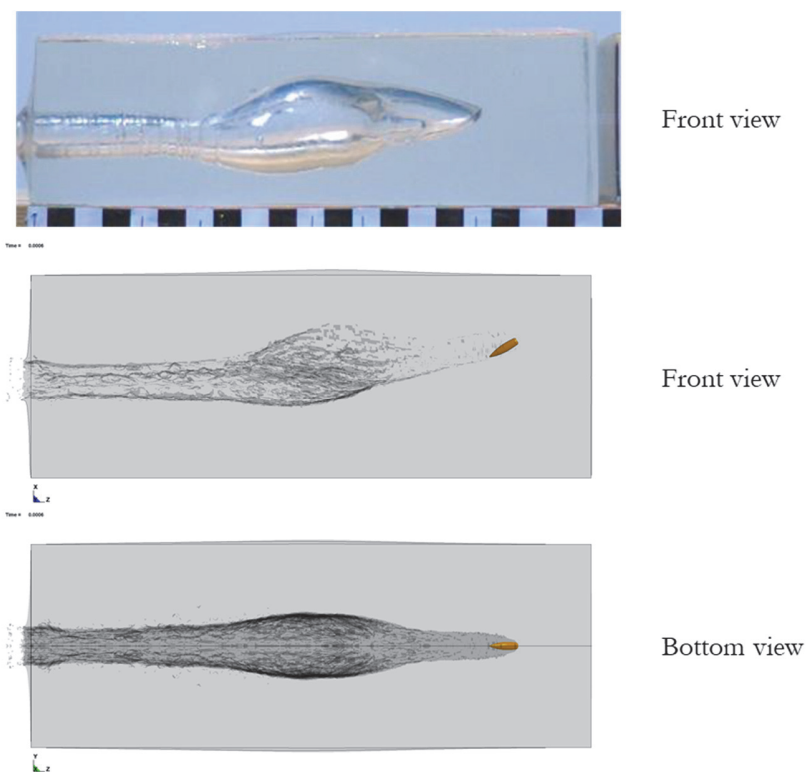

Figure 28: 5.56x45 mm NATO impact. Comparison between experimental results (above) and simulation seen from the two cross directions (below). Time = 0.6 ms. The resolution of the checkered ruler is 20 mm.

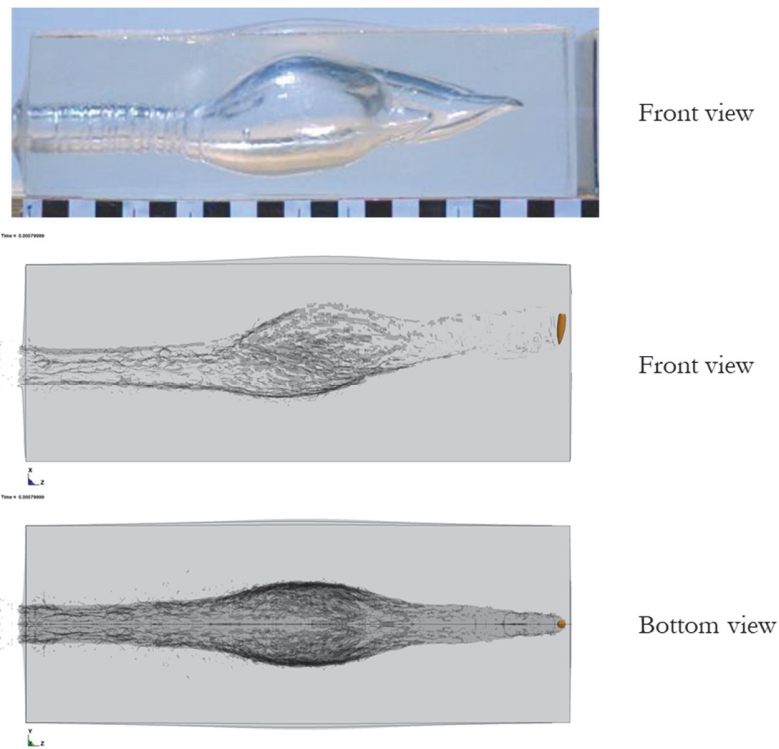

Figure 29: 5.56x45 mm NATO impact. Comparison between experimental results (above) and simulation seen from the two cross directions (below). Time = 0.8 ms. The resolution of the checkered ruler is 20 mm.

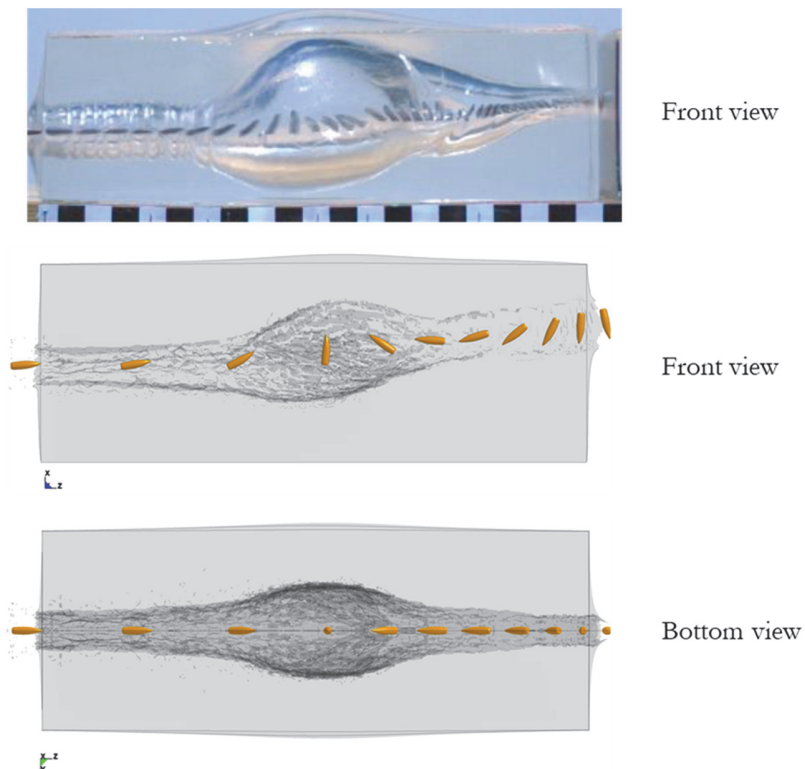

Figure 30: 5.56x45 mm NATO impact. Temporary cavities at escape time: experimental results at time 1.0 ms (above) compared to simulation results (below) at time 0.84 ms, seen from the two cross directions. Evolution of the bullet's kinematics during the penetration superimposed to the temporary cavity captured at escape time. The resolution of the checkered ruler is 20 mm.

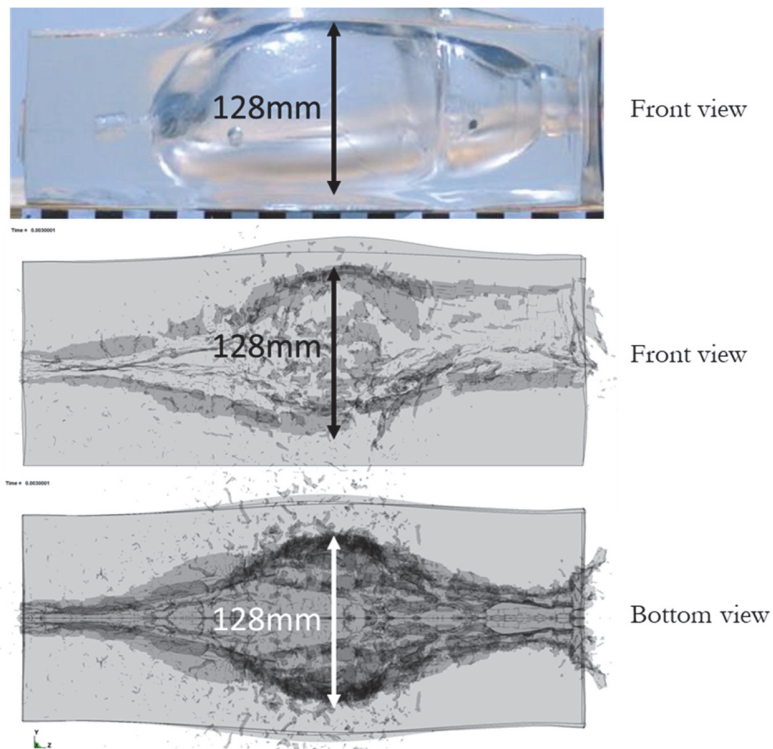

Figure 31: 5.56x45 mm NATO impact. Maximum cavity width: experimental results (above) compared to simulation seen from the two cross directions (below). Time = 3.0 ms. The resolution of the checkered ruler is 20 mm.

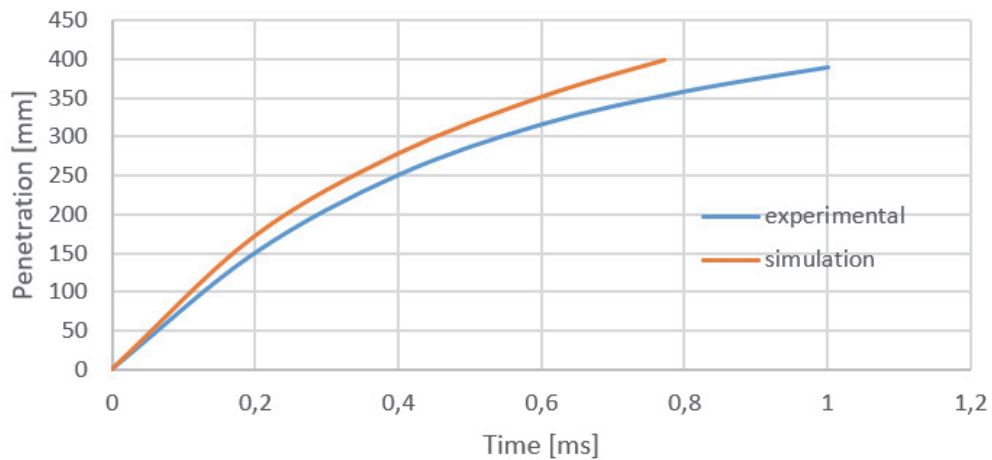

Figure 32: 5.56x45 mm NATO penetration as a function of time. Comparison between experimental results (blue line) and simulation (red line).

Cartridge	Absorbed energy [J] - Experimental	Absorbed energy [J] - Simulation (Error [%])
9x21 mm FMJ round-nose	404.32	483.88 (+20%)
7.62x39 mm FMJ	1582.45	1763.39 (+11%)
5.56x45 mm NATO	1617.28	1584.29 (-2%)

Table 3: Summary of the absorbed energy [J].

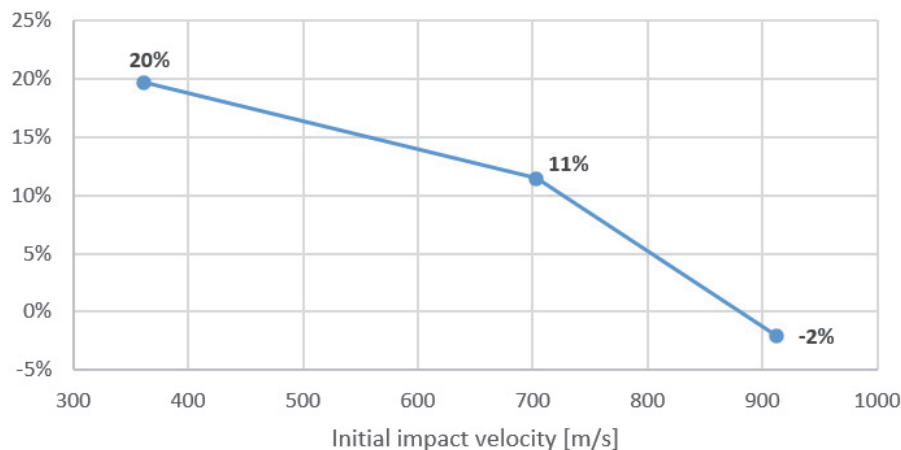

Figure 33: An overview of the percentage error in terms of absorbed energy and/or penetration force as related to the initial impact velocity of the bullets showing a clear trend of overestimation of the strength at low velocities and slight underestimation at high impact velocities.

CONCLUSIONS

All the results allow to conclude that the proposed simplified model is a valid tool to simulate the behavior of SEBS gels without complex experimental characterizations. The results can encourage researchers to experiment SEBS gels to conduct experimental and numerical tests by exploiting the numerous advantages of these materials as a valid substitute to biological gelatins. Moreover, the demonstrated effectiveness of the *Baligel* model, whose toughness parameters were derived from a constitutive model proved representative of Fackler gelatin, proves the similarity of the two materials for ballistic applications.

According to these conclusions, possible further developments of the research should involve the investigation of simplified ways to include the rate-dependance of the material's strength, as well as direct comparisons between Fackler gelatin and *Baligel*.

ACKNOWLEDGMENTS

Riccardo Andreotti and Mauro Quercia developed the constitutive model and conducted all the simulation and validation activities. Valentina Leggeri collected and analyzed the experimental data. Andrea Casaroli provided fundamental support and coordination for the experimental and numerical activities. Cristian Bettin developed the formulation of the synthetic gel as well as provided and handled the *Baligel* blocks. Mauro Zanella was responsible for the handling and operating of the high-speed cameras. Marco Boniardi leads the project and coordinated all the resources involved. The authors want to express their maximum gratitude to Sergio Bianco for the mastery and invaluable support, being responsible for the handling and shooting of the firearms during all the experimental activities. A special thank is also due to Mario Carli and the whole staff of the practice shooting range "Le Tre Piume SSD a r.l." Via Costanze 8, 35021 Agna (PD) Italy, for the generous and friendly hospitality.

Thanks to the anonymous reviewers for contributing to improving the manuscript.

REFERENCES

- [1] Coupland, R.M., Rothschild, M.A., Thali, M.J. (2011). *Wound Ballistics*, Berlin, Heidelberg, Springer Berlin Heidelberg.
- [2] Seidt, J.D., Pereira, J.M., Hammer, J.T., Gilat, A. (2013). Dynamic Load Measurement of Ballistic Gelatin Impact Using an Instrumented Tube. In: Chalivendra, V., Song, B., Casem, D., (Eds.), *Dynamic Behavior of Materials*, Volume 1, New York, NY, Springer New York, pp. 243–250.
- [3] Mauzac, O., Paquier, C., Debord, E., Barbillon, F., Mabire, P., Jacquet, J. (2010). A substitute of gelatin for the measurement of dynamic back face deformation.



- [4] Mrozek, R.A., Leighliter, B., Gold, C.S., Beringer, I.R., Yu, J.H., VanLandingham, M.R., Moy, P., Foster, M.H., Lenhart, J.L. (2015). The relationship between mechanical properties and ballistic penetration depth in a viscoelastic gel, *J. Mech. Behav. Biomed. Mater.*, 44, pp. 109–120, DOI: 10.1016/j.jmbbm.2015.01.001.
- [5] Bracq, A., Haugou, G., Delille, R., Lauro, F., Roth, S., Mauzac, O. (2017). Experimental study of the strain rate dependence of a synthetic gel for ballistic blunt trauma assessment, *J. Mech. Behav. Biomed. Mater.*, 72(April), pp. 138–147, DOI: 10.1016/j.jmbbm.2017.04.027.
- [6] Bracq, A., Haugou, G., Bourel, B., Maréchal, C., Lauro, F., Roth, S., Mauzac, O. (2018). On the modeling of a visco-hyperelastic polymer gel under blunt ballistic impacts, *Int. J. Impact Eng.*, 118(July 2017), pp. 78–90, DOI: 10.1016/j.ijimpeng.2018.04.001.
- [7] Shen, J., Taddei, L., Roth, S. (2022). Numerical modeling of a human tissue surrogate SEBS gel under high velocity impacts: investigation of the effect of the strain rate in an elasto-hydrodynamic law, *Mech. Adv. Mater. Struct.*, 29(2), pp. 241–249, DOI: 10.1080/15376494.2020.1761490.
- [8] Pullen, A., Kieser, D.C., Hooper, G. (2022). Ballistic gelatin calibration standardisation, *BMJ Mil. Heal.*, 168(2), pp. 124–127, DOI: 10.1136/bmjmilitary-2020-001430.
- [9] Wen, Y., Xu, C., Wang, H., Chen, A., Batra, R.C. (2013). International Journal of Impact Engineering Impact of steel spheres on ballistic gelatin at moderate velocities, *Int. J. Impact Eng.*, 62, pp. 142–151, DOI: 10.1016/j.ijimpeng.2013.07.002.
- [10] Wen, Y., Xu, C., Jin, Y., Batra, R.C. (2017). Journal of the Mechanical Behavior of Biomedical Materials Rifle bullet penetration into ballistic gelatin, *J. Mech. Behav. Biomed. Mater.*, 67(June 2016), pp. 40–50, DOI: 10.1016/j.jmbbm.2016.11.021.
- [11] LSTC. (2015). LS-DYNA R8.0 Keyword User's Manual - II - Material Models.
- [12] Johnson, A.F., Holzapfel, M. (2003). Modelling soft body impact on composite structures, 61, pp. 103–113, DOI: 10.1016/S0263-8223(03)00033-3.
- [13] Johnson, A.F., Holzapfel, A.E.M. (2006). Numerical prediction of damage in composite structures from soft body impacts, , pp. 6622–6630, DOI: 10.1007/s10853-006-0201-x.
- [14] Mori, K.N.Y., Nakahara, Y.M.M. (2006). Shock Hugoniot for biological materials, , pp. 267–275, DOI: 10.1007/s00193-006-0030-5.
- [15] Howell, B.E. (2010). Aerodynamic and Flight Dynamic Characteristics of 5. 56-mm Ammunition: M855 .
- [16] Celmins, I. (2011). Accuracy and Jump Measurements of the 5. 56-mm M855 Cartridge.