

A CASE STUDY: INTELLIGENT SHADING RETROFIT TO EXISTING HOME-OFFICE USING MULTI-OBJECTIVE OPTIMIZATION

Tajik, Ramyar,¹ Soltanmohammadlou, Saeideh,² Kianfar, Amir,² Masera, Gabriele,² Hoque, Simi^{1,*}

ABSTRACT

Improved energy performance and occupant comfort are driving building design decisions due to the increasing demand for sustainable and green buildings. However, despite the variety of technological developments in other fields, the range of solutions to improve building performance is limited. One of the main limitations for an early designer is a performance evaluation method to facilitate the design process. This paper offers a new shading performance optimization process that can help designers evaluate both daylighting and energy performance and generate optimized and flexible designs that can be further improved by implementing user-specific automation.

The proposed performance optimization method utilizes parametric design, building simulation models, and Genetic Algorithms. Common shading design systems are explored through parametric design, and daylighting and energy modeling simulations are performed to evaluate shading device performance. Genetic Algorithms are used to identify design options with optimal energy and daylighting performance. A case study is conducted to verify the effectiveness of the overall process. Results are used to analyze the influence of design decisions among different shading designs. Finally, future directions in both shading design and energy optimization are presented.

KEYWORDS

multi-objective optimization; optimization; parametric design; Roller Blinds; shading design; smart building; Venetian blinds, United Nations' sustainable development goals

1. INTRODUCTION AND BACKGROUND

The global energy crisis and the imperative of sustainability have spurred concerns worldwide. As climate change tests the boundaries of environmental responsibility, the field of architectural engineering emerges as a pivotal player in tackling these challenges. One of the pivotal strategies to mitigate energy consumption within structures is the optimization of building

1. Drexel University, Philadelphia USA Email: rt626@drexel.edu

2. Politecnico di Milano, Milan Italy

*Corresponding Author Email: sth55@drexel.edu

envelope efficiency. Solar access and daylight have a host of positive effects on building energy performance, occupant comfort, and productivity (Alotaibi 2015). These solutions have several potential benefits, such as reducing energy use and greenhouse gas emissions, and can also help improve occupant well-being and productivity (Nicol, Wilson et al. 2006). This holds particular significance given that buildings are responsible for approximately 40% of the world's total energy usage (Janssen 2004), a contribution that significantly exacerbates environmental pollution and climate change (United Nations Environment Programme 2020). It is incumbent upon the architecture, engineering, and construction (AEC) industry to confront the pressing task of energy reduction while concurrently elevating human comfort, safeguarding finite resources, and aligning with the United Nations' sustainable development goals.

Traditional building design aspires to create sanctuaries that shield occupants from external influences, including extreme temperatures, wind, rain, noise, and radiation. Achieving this delicate equilibrium—where exterior protection harmonizes with interior well-being, while energy consumption remains minimal—has posed an enduring challenge (Roulet 2001). The interaction of diverse design parameters, encompassing outdoor conditions, meteorological variables, and solar angles, exerts a profound influence on both occupant comfort and building envelope performance.

In a parallel discourse, intelligent shading systems have garnered substantial attention. These systems stand as a potential remedy for managing energy consumption and augmenting occupant comfort by curbing direct solar exposure to prevent overheating and optimizing daylighting (Al-Tamimi and Fadzil 2011). While these systems have predominantly found application in commercial and expansive office spaces, their adaptation to the unique requisites of home-office settings remains an underexplored avenue. This gap in application gains pertinence considering the Covid-19 pandemic, which has ushered in a pronounced surge in remote working and bolstered the significance of the home-office as an individual's personal domain.

Moreover, while earlier studies have delved into the optimization of fenestration to enhance daylighting and energy performance, they often exhibit shortcomings in pivotal areas. While some investigations have incorporated optimization methods to model and control performance in both daylighting and energy consumption, their applications have been confined to localized contexts. The broader potential of employing global optimization methods in scenarios like home-office environments—a category which has witnessed a paradigm shift considering the remote-working trend—remains largely uncharted.

For instance, studies by (Manzan 2014) and (Lakhdari, Sriti et al. 2021) aptly showcase the efficacy of optimization techniques in enhancing daylighting and energy performance, yet their focus has either been predominantly on commercial spaces or they only considered static shading strategies. The ramifications of these findings for home-office environments, especially in cases where dynamic shading systems are utilized, have been left unaddressed. Similarly, while the contributions of (Korkmaz, Messner et al. 2010) and (Pesenti, Masera et al. 2018) spotlight the potential of simulation tools in designing dynamic shading systems, they are primarily centered on general applications, bypassing the unique dynamics of home-office environments.

As computational technology advances, a myriad of building simulation tools have surfaced, serving as invaluable aids for designers and engineers in assessing building envelope performance. The utility of building performance simulation extends across various design and construction phases, with particular promise at the early design juncture—the moment when most crucial envelope decisions are taken, offering the most substantial potential for achieving high-performance outcomes (Bunz, Henze et al. 2006, Bragança, Vieira et al. 2014,

Moghtadernejad, Mirza et al. 2019). These studies illuminate the potency of simulation tools in enabling a systematic approach to designing dynamic shading systems, encompassing aspects of design, operation, and control. Similarly, (Pesenti, Masera et al. 2018) effectively leverage simulation tools to fabricate a self-adapting origami-shaped dynamic shading system, thereby highlighting the versatility of simulation methodologies.

In further study, (Abdelwahab and Sobh 2022) offer a compelling illustration through their development of a daylight and glare simulation workflow, individualizing dynamic shading to specific windows. However, despite the advancements in this body of scholarship, which advances building envelope strategies, the design of dynamic shading systems and their intricate implications for comfort and energy demand across diverse climate scenarios persist as multifaceted puzzles. The formulation of a pragmatic and optimized dynamic shading system necessitates an assembly of models, components, and mechanisms, each orchestrated with distinct control strategies contingent upon factors like solar orientation, meteorological conditions, occupant preferences, energy targets, and aesthetic considerations. In parallel, pragmatic elements such as cost, maintenance, and technical installation warrant careful consideration.

Considering these prevailing gaps within the existing academic discourse, this study undertakes a vital endeavor—forging a comprehensive and adaptable optimization approach tailored specifically to the demands of home-office settings. By adopting global optimization methods, in contrast to the restricted localized methods employed in prior research, our endeavor aims to bridge the chasm between energy efficiency and occupant comfort within the rapidly evolving landscape of remote work. Rooted in these aspirations, our study centers upon designing shading devices that holistically optimize daylighting to enrich occupant comfort while fostering energy conservation.

Building on existing scholarship, our research introduces genetic algorithms and machine learning methodologies as pioneering analytical frameworks for designing shading systems. To realize this ambition, we introduce a non-deterministic methodology, enabling the design of shading devices in office environments, leveraging passive operation under a predetermined schedule. We harness the NSGA II genetic algorithm optimization techniques (Deb, Pratap et al. 2002), coupling them with an integrated approach to daylight and energy balance simulation. Our methodology hinges upon the intricate interplay between simulated energy and daylight calculations, coupled with a synthesis of diverse control strategies for dynamic shading systems. To validate and illuminate the efficacy of our methodology, we test it within the context of a case study—an individual's home office located in Lecco, Italy. Our primary objective is to ascertain the most optimal design variables and control strategies that harmoniously curate energy costs and elevate occupant comfort.

In weaving this comprehensive fabric of research, we aspire to enrich the collective understanding of the nuanced interplay between dynamic shading systems, energy efficiency, and the well-being of occupants in the realm of contemporary home-office environments. As the trajectory of remote work continues to shape our built environment, our findings hold the promise of yielding crucial insights for the design of sustainable and comfortable home-office spaces that resonate harmoniously with the evolving landscape of modern work culture.

2. METHODOLOGY

This study is divided into two primary parts, focusing on distinct aspects of optimizing fenestration strategies in a home-office setting.

2.1 Part 1: Simulation for Fenestration Strategy Selection

The initial phase of the study embarks on a quick simulation to evaluate and compare various fenestration strategies, specifically considering kinetic or static compositions. The comparison is drawn based on the total cooling load, heating load, and electrical load of the home-office, providing a comprehensive analysis of the energy performance. Additionally, a side note observation is made to understand the room for improvement, where monthly mean solar gain vs. mean illuminance is considered. A threshold of over 150 lux (regarded as useful daylight illuminance until 1500 lux) and under 3000 lux (considered due to the high probability of glare for illuminance over that) is employed to gauge the potential enhancements.

The systematic process in Part 1 involves the following steps:

- Exploration of common shading design systems through parametric design.
- Building simulation models to evaluate shading device performance in terms of daylighting, cooling load, heating load, and electrical load.
- A specific review of the monthly mean solar gain vs. mean illuminance, taking into account thresholds that indicate useful daylight and potential glare.

2.2 Part 2: Global Optimization for Physical Composition

In the second phase, the study further refines the selected fenestration strategy. The process begins with the utilization of an automation algorithm in modeling the home-office shading system. This step is instrumental in establishing the foundational geometrical properties of the shading system and understanding their relationships with solar gain and Useful Daylight Illuminance (UDI).

Following the automation algorithm, a global optimization method is employed to enhance the shading system's geometrical properties. This optimization focuses not only on the cooling load, heating load, and electrical load but also considers additional parameters such as UDI and Average Glare. This multifaceted optimization ensures a comprehensive analysis that takes into account various aspects of energy efficiency, daylighting performance, and occupant comfort.

The methodology for Part 2 includes:

- Utilizing an automation algorithm to model the home-office shading system, establishing initial geometrical properties and their relationships with solar gain and UDI.
- Applying global optimization methods to refine and improve the shading system's geometrical properties, targeting cooling load, heating load, electrical load, UDI, and glare.
- Integrating the optimized shading system into a detailed building simulation model to evaluate its performance in a real-world context.

The synergy between the automation algorithm and the global optimization method in Part 2 provides a nuanced and iterative approach to shading system design. The sequential application of these methods allows for progressive refinement, leading to a solution that is both energy-efficient and conducive to a comfortable and productive home-office environment.

3. CASE STUDY DESCRIPTION

The case study is a home office located in the city of Lecco, in northern Italy. The home office is on the 3rd floor of a multifunctional building. According to the Köppen climate classification,

Lecco is located in the North of Italy, situated at the base of the Eastern branch of Lake Como. Located at an altitude of 197 m, the city of Lecco has the following coordinates: 45°51'12" North, 9°23'45" East. The average altitude of Lecco is 100 m above sea level. At this latitude and longitude, the weather is considered a humid subtropical climate zone. Summer is typically hot and humid, while winters are moderately cold. Winter average temperatures are around 1°C to 3°C, and summers often exceed 26°C (climate 2023). Summers are mild in the hills and quite hot in the plains. July is the warmest month, with maximum temperatures reaching 28°C, and December is the coolest month with a minimum of -1.5°C (Climate-Data.org 2023). Moreover, May to September are the months that require cooling, while from mid-October until March, heating is needed (this information is crucial for heating and cooling load calculations, taking into account working hours, material properties, and ventilation systems of the building under study). Rain is a frequent phenomenon and abundant throughout the year, with May being the wettest month (Spark 2023). Considering a base of 20°C for heating and a base of 24°C for cooling, Lecco's Heating Degree Days (HDD) and Cooling Degree Days (CDD) Calculated by (De Rosa, Bianco et al. 2015) for the year 2013 respectively are 2753 and 86.

The incident solar radiation study, both direct and diffuse, indicates that there is a reasonable opportunity to utilize daylight in Lecco. The length of the day varies from 9 to 16 h from winter to summer, respectively (climate 2023). However, care must be taken to prevent overheating the buildings during the hot summer months due to the useful amount of radiation. Thoughtful planning is essential in balancing daylighting versus cooling loads. Despite Lecco's picturesque location on the banks of Lake Como, the city suffers relatively in terms of climate in the winter. From November to March, temperatures often fall below freezing, especially in December and January, with snowfall sometimes very intense. Relative humidity in Lecco ranges from 45% to 93%, being mostly humid in October, while June is generally drier (climate 2023).

Climate and weather data are extracted from the EnergyPlus weather file of Lecco climate by using the Ladybug component of Grasshopper Rhino.

The height of the home office (from ground to the ceiling) is 3 meters. The space area is approximately 18 square meters, and it is confined by three interior walls and one exterior wall. The exterior wall is in a southwest orientation and has two windows, the total area of the windows is 7 square meters. The height of the windows is 2.7 meters. The U-factors of the ceiling, floor, interior, exterior walls, and windows are presented in (Table 1). The walls are assumed to have two layers of hollow brick + insulation, and the windows are insulated double glass. Figure 1 presents a floor plan of the office (on the right).

TABLE 1. Building elements and their properties.

Element	U-Value	Thickness [m]	Ext. Surface Material	Int. Surface Material	Ext. Surface Color	Int. Surface Color
Exterior Wall	0.25	0.35	Cement Lime Plaster	Plaster	#D6753F	#FFFFFF
Interior Floor	2.64	0.19	N/A	Plaster	N/A	#FFFFFF
Interior Ceiling	2.64	0.19	N/A	Plaster	N/A	#FFFFFF
Interior Wall	1.63	0.2	N/A	Plaster	N/A	#FFFFFF
Window	3.5	0.03	N/A	N/A	N/A	N/A

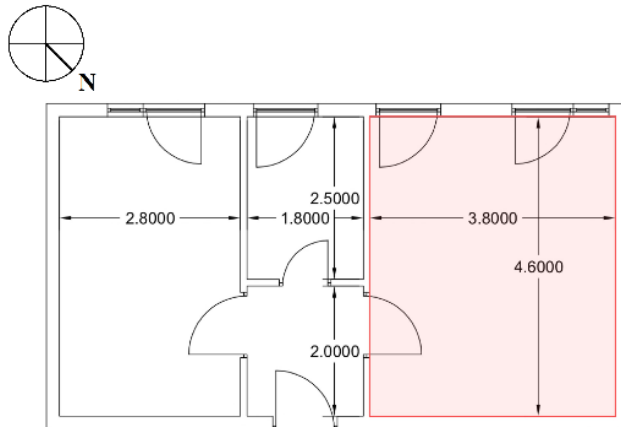
FIGURE 1. Studied office drawing—dimension in meters.

3.1 Simulation Baselines

3.1.1 Simulation Period

The simulation period is reduced from the whole year to the 21st day of each month from 9 am to 5 pm. This period was chosen to reduce the number of simulations needed since each hour must be simulated separately. This approach offers an adequate representation of the seasonal variation of the sky for daylighting assessment and corresponds with the typical occupied office hours for energy performance assessment.

3.1.2 Energy Simulation Baselines

Default small office schedules and load rates used for all energy simulation from this point forward in the study are indicated in (Table 2). Note that these are the baseline values used in all simulations unless indicated otherwise in a specific section of the study.

3.1.3 Impact Of Sky Models

Different sky models are adopted according to the needs of each project. Climate-based sky model, diffusive sky model, sunny with the sun, and sunny without sun are some of the most utilized sky models in research related to daylighting (Mardaljevic 1999).

TABLE 2. Default Inputs for Small Office.

Equipment Load Per Area (W/m^2)	7.6424
Infiltration Rate Per Area—Façade ($\text{m}^3 / \text{s}\cdot\text{m}^2$)	0.0002
Lighting Density Per Area (W/m^2)	11.8404
Number Of People Per Area (ppl/ m^2)	0.0565
Ventilation Per Area ($\text{m}^3 / \text{s}\cdot\text{m}^2$)	0.0003
Ventilation Per Person ($\text{m}^3 / \text{s}\cdot\text{person}$)	0.0024

This project adopts a climate-based sky model due to its variation of sky models for each hour. A climate-based sky model is appropriate in this context because other models are uniform or do not consider variations of the sky (Mardaljevic 1999, Mardaljevic 2006). A climate-based sky model adds a degree of unpredictability, especially in the case of direct sunlight, which improves the project to detect and respond to natural conditions. This choice also enables us to simulate solar gains inside the room, which is not achievable using other sky models. Figure 2 shows plots of the sky luminance and a false-color luminance map of the climate-based sky model.

Climate-based daylight modeling predicts luminous quantities (i.e., illuminance or luminance) using realistic sun and sky conditions derived from data in standardized climate files. A climate-based analysis is intended to capture all the unique sun and sky conditions over a period rather than be simply a “snapshot” of specific conditions at a particular instant (Mardaljevic 2006). In this study, one day per month was simulated to represent the seasonal change to reduce the load of simulations required to a feasible amount.

3.2 Shading Design and Strategy

Two specific shading systems are selected to be analyzed: Venetian blinds and roller blinds. These two shading systems are most commonly used, easy to control, and durable. Venetians are not only common, durable, and easily controllable, but they also are suitable for external use. Roller blinds are typical and effective in controlling glare, though they may be less durable if used in external environments. Roller blinds are modeled in this study as internal shading devices, similar to most real-world applications.

3.2.1 Phase 1—Dynamic vs. Static

Several shading strategies (Figure 3) are explored and compared to see which strategy optimizes daylighting and energy performance. We also designed strategies that have a more significant potential to support user-specific automation. These strategies are variants of external Venetian shading and internal roller blinds over windows.

3.2.1.1 Static Venetian Blinds Properties

The following section examines strategies that utilize static, external Venetian blinds. The Venetian blinds utilize EnergyPlus’s “FullInteriorAndExteriorWithReflections” properties for

FIGURE 2. Climate based sky model.

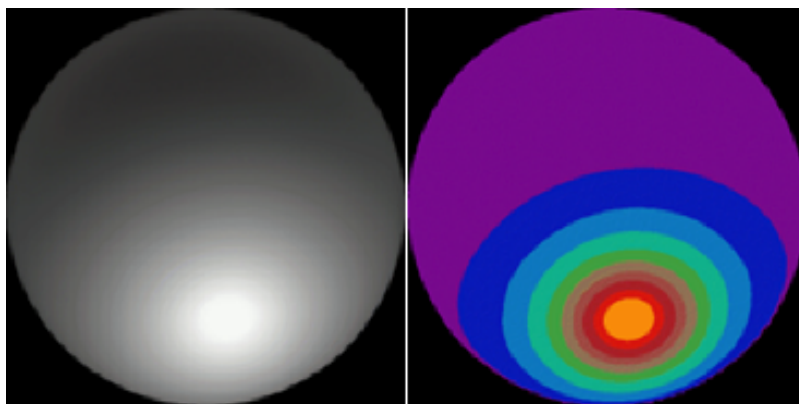
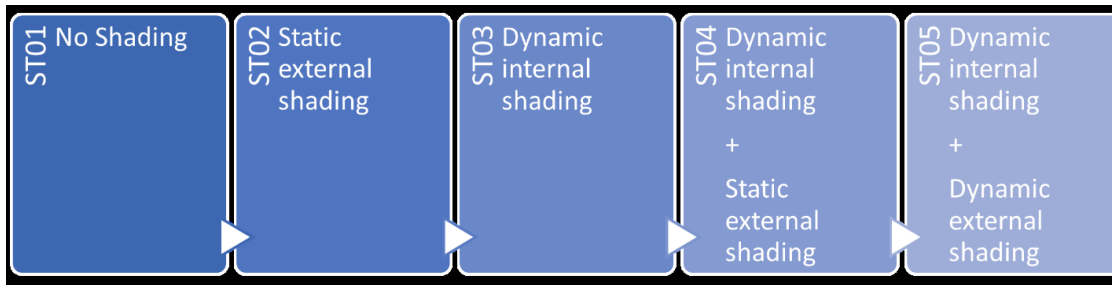

FIGURE 3. Five strategies for shading control.



their slats and have a height of 70cm, measured from the top of the windows. Six slats cover the window height, each with a width of 12cm. Annual simulations focus on daylight autonomy. Daylight Autonomy is a daylight availability metric that relates to the percentage of occupied time when daylight meets the specified illuminance at a place in a space (Reinhart and Walkenhorst 2001). The simulations on the work-plane are conducted to find the best possible angle for the slats in the range from -45° to 45° (Figure 5). The average work-plane daylight autonomy for different slat angles is compared (Figure 6), and slats in -35° (Figure 4) are chosen.

AUTOMATION STRATEGIES

The following automation decision trees are utilized for dynamic shading strategies to adjust the Venetian slat rotational position and the length covered by the roller blinds.

FIGURE 4. DLA (daylight autonomy) on work-plane with slats at -35° .

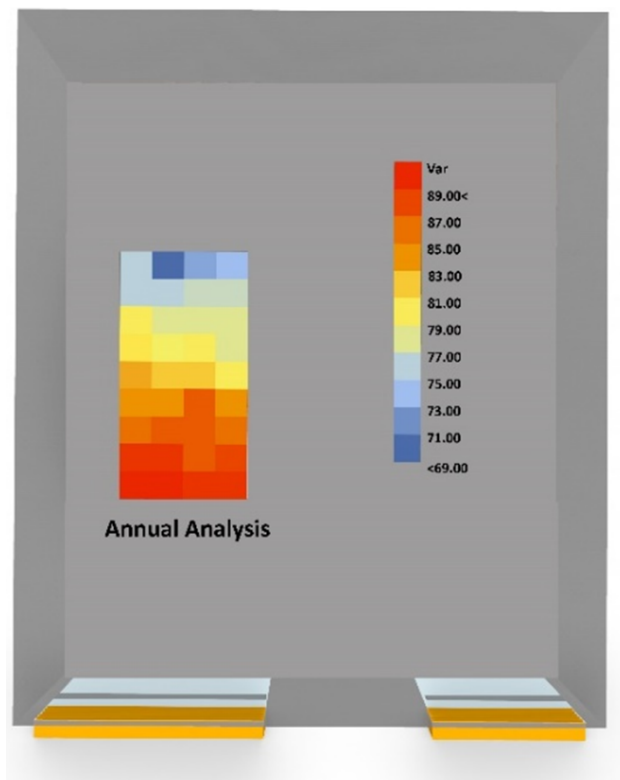

FIGURE 5. Venetian shading slat rotation range.

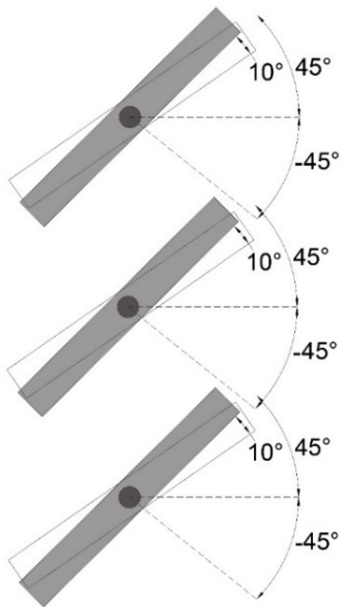
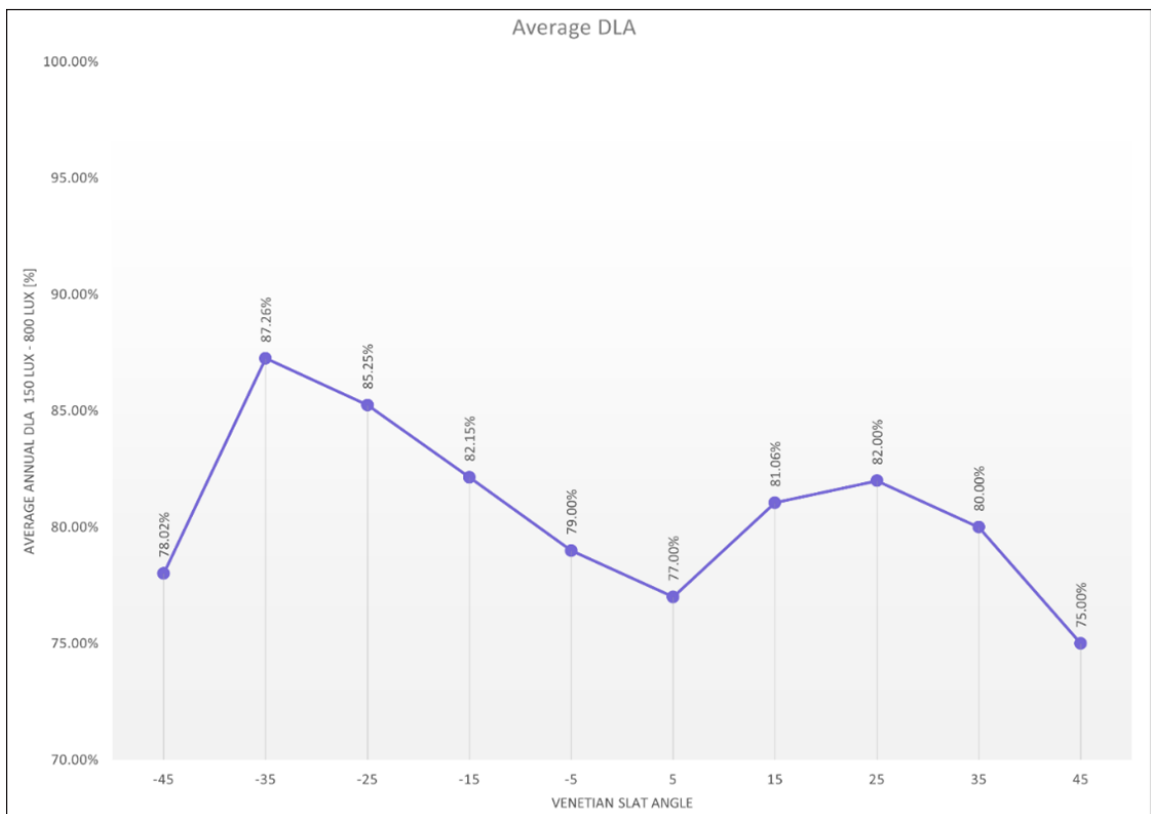

FIGURE 6. Average DLA (daylight autonomy) of Venetian different slat angle.



3.2.1.2 *Dynamic Internal Roller Blinds Properties*

Dynamic internal roller blinds used in the following section of this study are automated based on the amount of direct solar radiation entering the window. The roller's diffuse transmission is 30%, and roughness, specular reflection, and specular transmission 0% and (105,105,105) gray. For strategies utilizing dynamic roller blinds, at each instant, the automation initially checks the working hour status, defined as time hour that the user is present and counted as running time in the predefined schedule. This method is chosen over a fixed schedule, so the system would also have the potential to introduce a sensor-based user-presence control instead of a fixed schedule. In case the previous check confirms working-hour status, the system checks for the presence of any external shade over the window such as a cloudy sky. In such cases, it considers 0.65 kWh/m^2 (maximum possible radiation on the window) as the maximum threshold and 0.15 kWh/m^2 (lowest radiation that provides at least 150 lux (de Vries, Souman et al. 2020) through the window) as the minimum. The automation remaps these values for roller height values between 0 to 250cm (Figure 7). This remapping strategy is chosen to minimize the radiation through the lower two-thirds of the window height and control the glare while maintaining comfortable illumination, i.e. under 1500 lux (Wienold and Christoffersen 2006), and reducing glare by considering illumination over 3000 lux fatigue and glare-inducing (Lin, Lin et al. 2008) as a priority.

3.2.1.3 *Dynamic External Venetian Blinds and Internal Roller Blinds*

Keeping the same strategy for internal roller blinds system, in cases where external Venetians are also motorized, the following automation system is applied. The external shading automation systems are designed to keep the slats perpendicular to the direct sun vector hitting each slat in the summer period and conversely parallel in the winter position. This system attempts to maximize solar gain in the winter and minimize solar gain in the summer (Figure 8).

3.2.1.4 *Strategy 01—No Shading (ST01)*

The first strategy that we simulated is a window without shading (Figure 3). This strategy is applied to determine if there is a need for shading devices. Figure 9 shows the total load in the room for one day in each month, broken up by the type of loads. This figure indicates a surge in cooling load in hotter months due to the solar gains. Figure 10 shows the solar gain from the two windows in the home office and diffuse global illuminance and average illuminance inside the room. Two thresholds of 3000 lux indicating glare for average illuminance values above it and 1500 lux indicating maximum average illuminance considered comfortable are also represented on this figure. These two thresholds facilitate the comparison of illuminance performance between strategies. This figure shows a rise in solar gains in the hotter months, although small compared to increases in colder months. The breakdown of loads in Figure 9 indicates that the rise in solar gains in March is beneficial in reducing the heating load. However, although still helpful in reducing the heating load, the rise in October precipitates a slight increase in the cooling load.

3.2.1.5 *Strategy 02—Static External Shading (ST02)*

The second strategy is a static external Venetian blind with properties described in the “Static Venetian properties” section. The energy loads of the room for this strategy are presented in Figure 11, which indicates slight increases in heating loads in colder months and slight decreases in cooling loads in hotter months as anticipated. The effect of the new strategy on these changes in cooling and heating loads is apparent by the decreases in solar gains in Figure 12, which shows

FIGURE 7. Graphical diagram of the third strategy02.

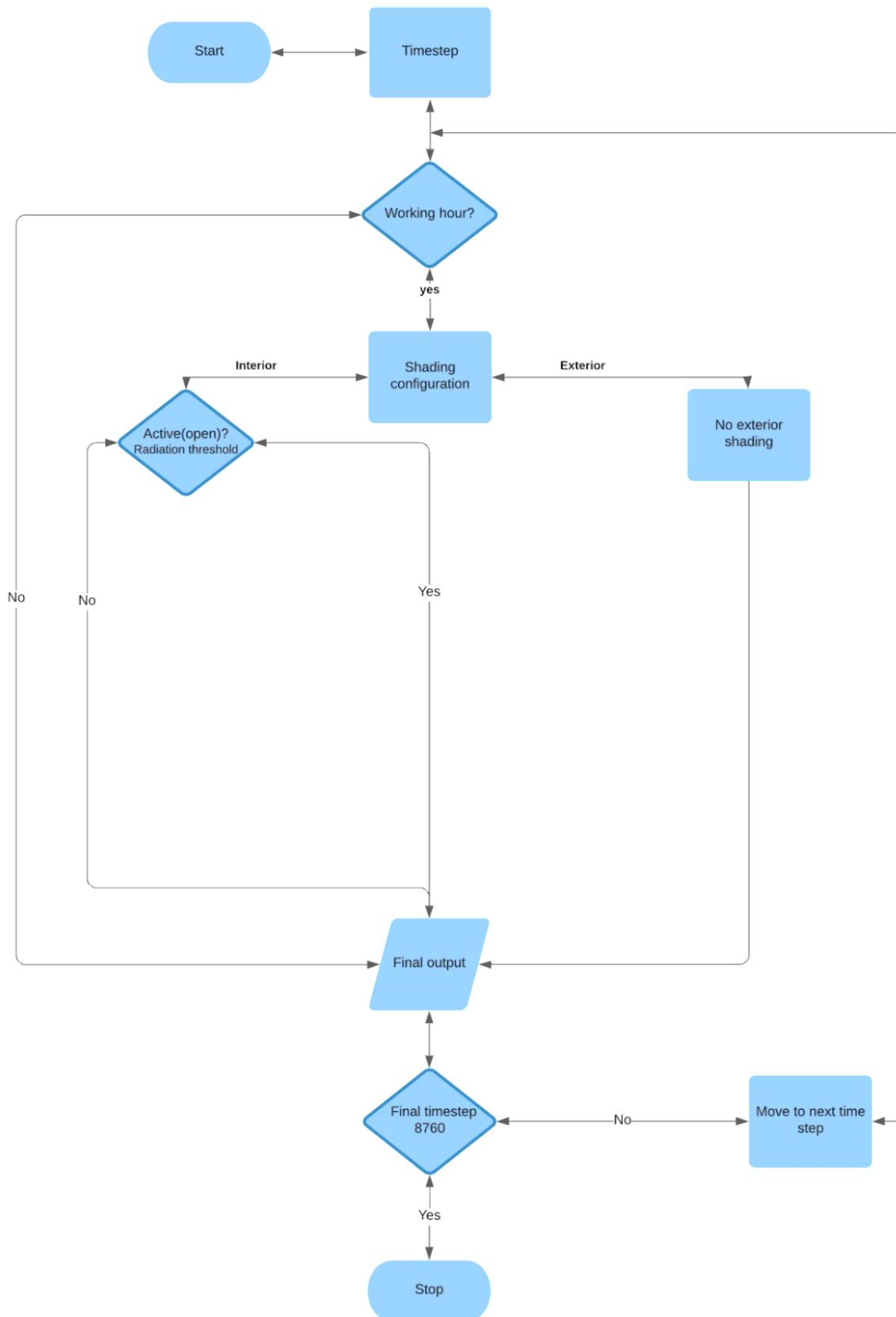

FIGURE 8. Graphical representation of preliminary automation of Venetian blinds.

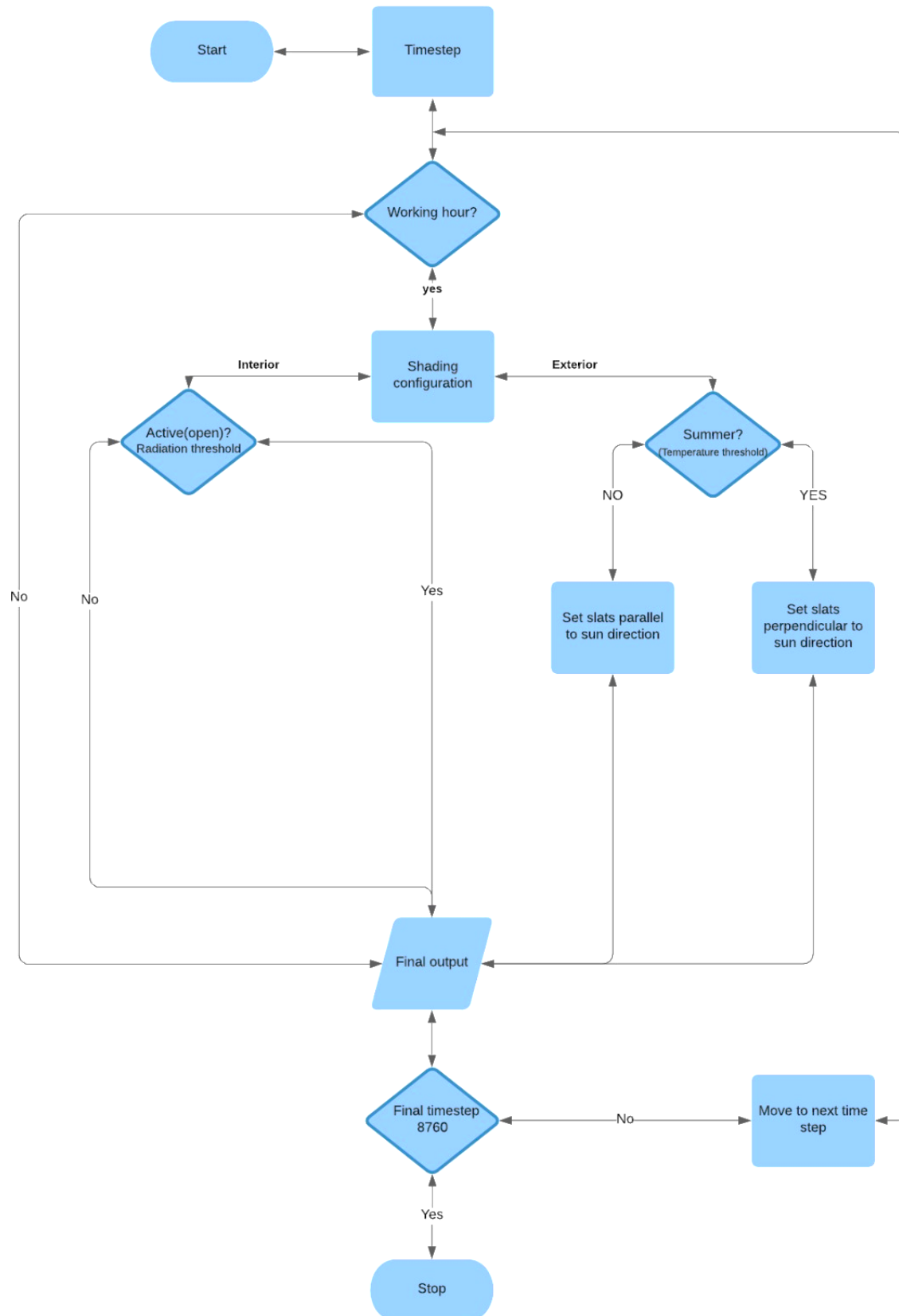

FIGURE 9. Heating-Cooling-Electrical load ST01.

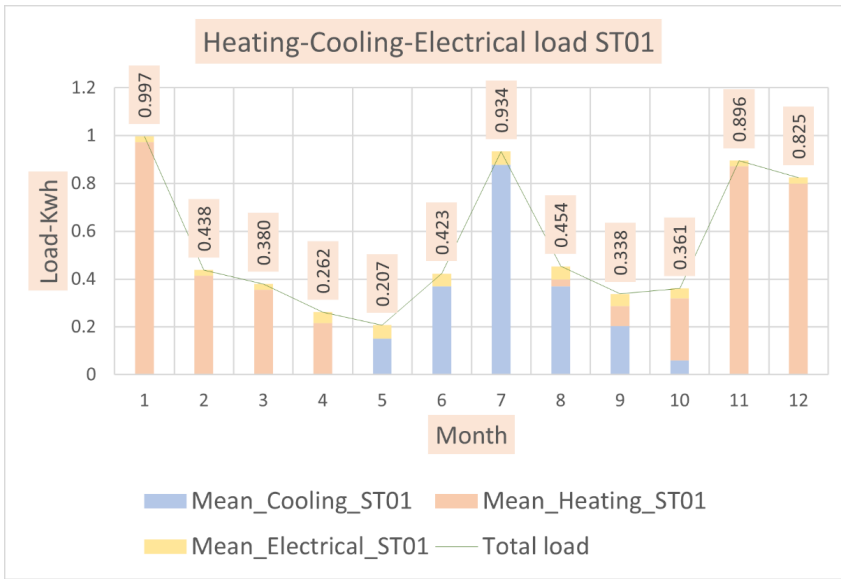

FIGURE 10. Comparison of solar radiation-ST01.

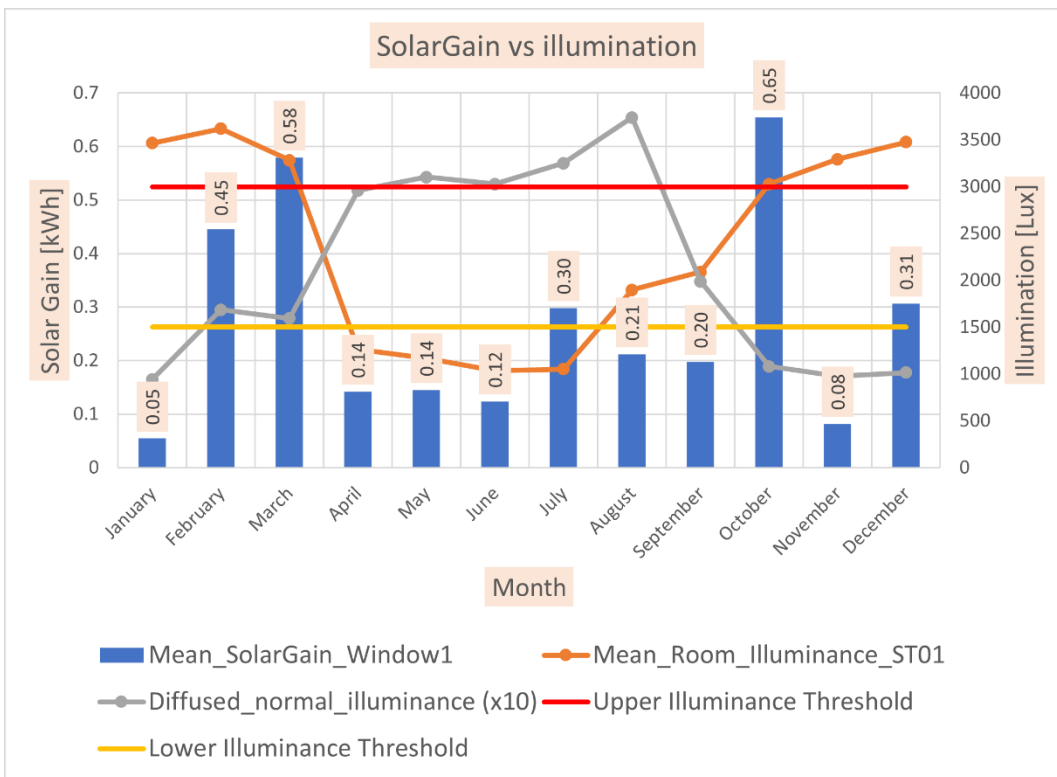

FIGURE 11. Heating-Cooling-Electrical load ST02.

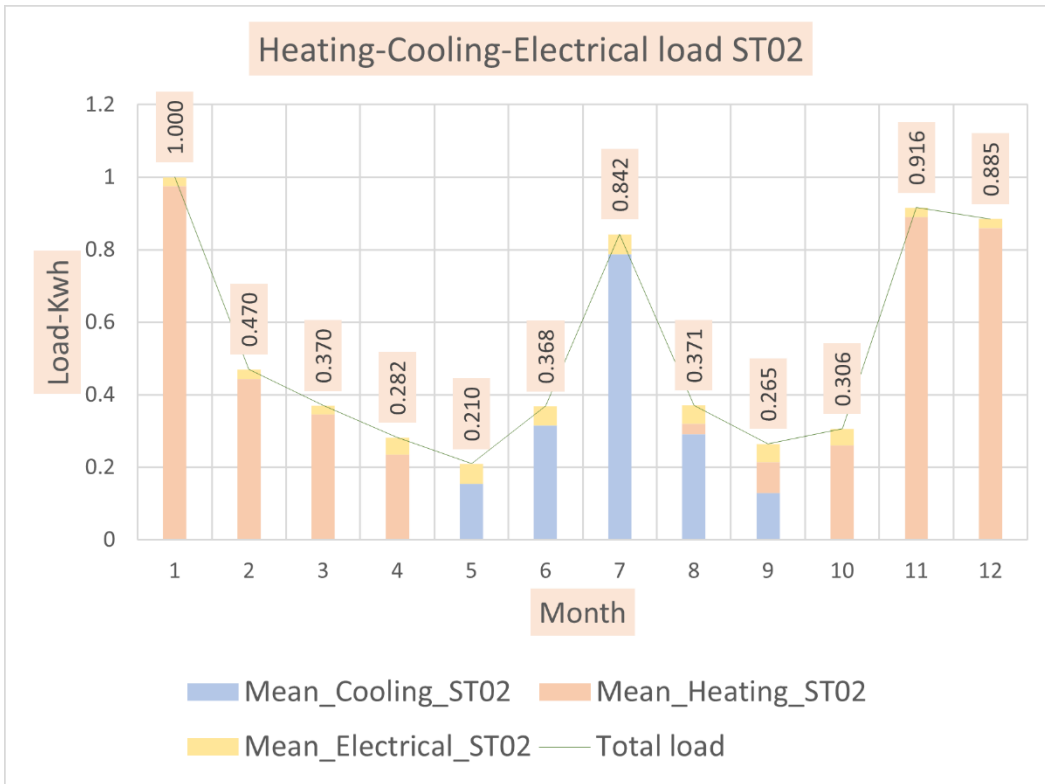
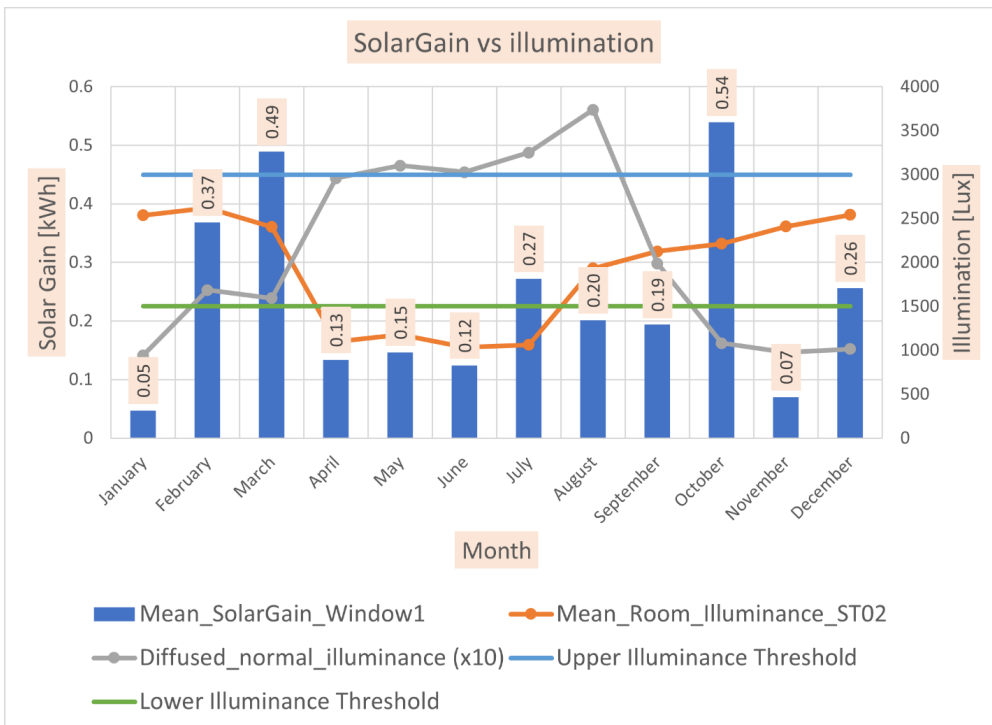

FIGURE 12. Comparison of solar radiation-ST02.



the solar gains through the two windows in the room for each month. Figure 12 also indicates a significant improvement in controlling the glare-inducing illuminance inside the room. It shows that the mean illuminance in the room remains below the maximum threshold value of 3000 lux all year as opposed to the previous strategy, which had five months above the maximum.

3.2.1.6 Strategy 03—Dynamic Internal Shading (ST03)

The third strategy utilizes automated dynamic internal roller blinds based on the amount of direct solar radiation perpendicular to the window. This choice is to exercise more control over solar gain, specifically maximizing its benefits in colder months and reducing its effect in hotter months. In Figure 13, the sole use of dynamic internal roller blinds did not improve control over solar gains as the cooling load in hotter months increased even more than the first strategy with no shading. This increase could be because the internal roller blinds trap more heat inside the room, between the blind and the window, which then conducts into the room increasing the internal air temperature. However, internal blinds do offer a decrease in heating loads in colder months, as it can be rolled up to enable solar gains in colder months for passive heating. Figure 14 indicates this increase in solar gain in both colder and hotter months.

3.2.1.7 Strategy 04—Dynamic Internal Shading and Static External Shading (ST04)

The fourth strategy includes both static external shading and dynamic internal shadings which has been suggested in the literature to be more beneficial (Chan and Tzempelikos 2015). The goal is to simultaneously utilize the benefits of static external shading and dynamic internal shading. A multi-sectional façade typically consists of three sections: a top portion with daylighting devices, a middle portion with adjustable shade devices that preserve the inhabitants' visual connection with the outdoors while maintaining their visual comfort, and a spandrel section for decreasing heat loss (Do and Chan 2020). In this study, the window upper section is covered by external Venetian shades, while dynamic internal roller blinds shade the middle to the bottom. However, as seen in Figure 15, we do not see significant improvements in colder months nor in hotter months in terms of reducing heating or cooling loads. Figure 16 shows even worse effects on solar gain, indicating increases in hotter months and decreases in colder

FIGURE 13. Heating-Cooling-Electrical load ST03.

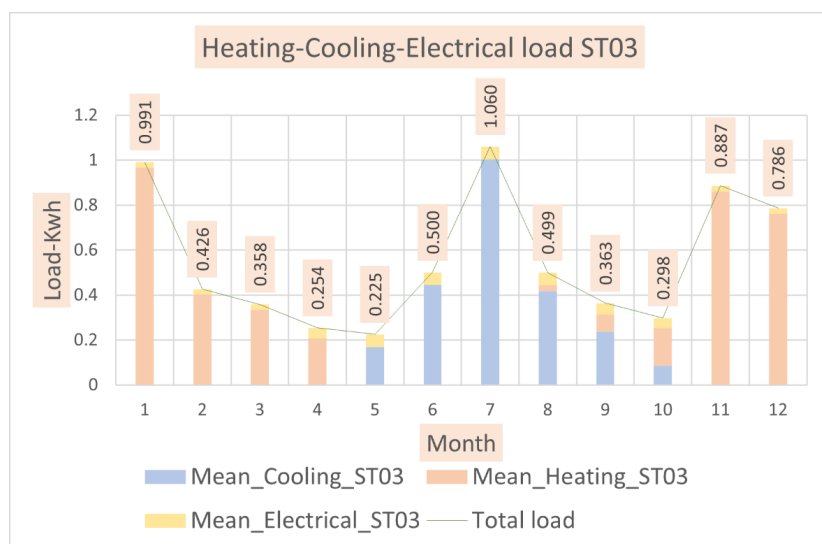
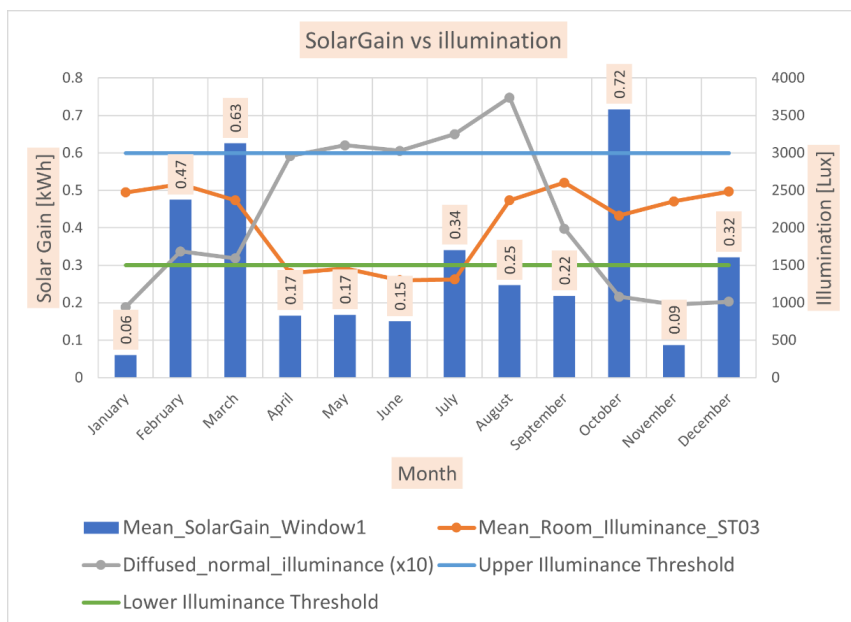
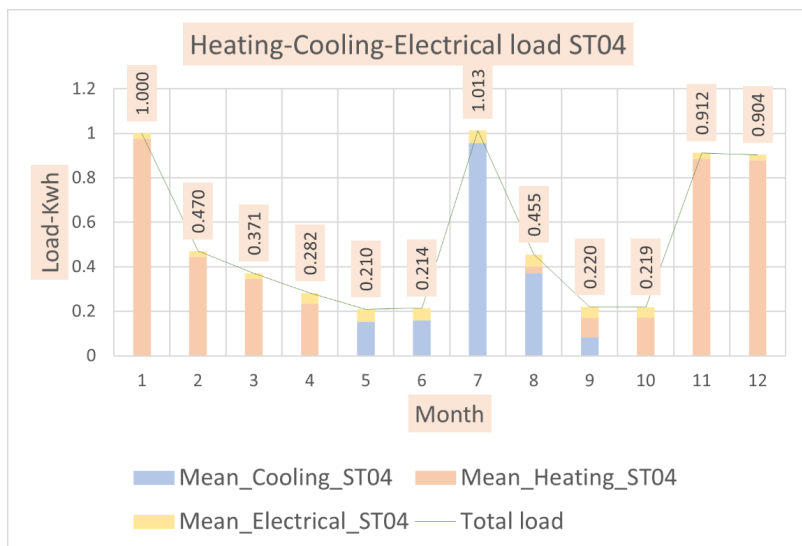

FIGURE 14. Comparison of solar radiation-ST03.**FIGURE 15.** Heating-Cooling-Electrical load ST04.

months. Furthermore, the mean illuminance inside the room in Figure 16, is primarily close or under the 1500 lux line, which indicates that this strategy also disadvantages the illuminance inside the room.

3.2.1.8 Strategy 05—Dynamic Internal Shading and Dynamic External Shading (ST05)

The fifth and final strategy is the same as the fourth, except that the external shading is also dynamic and automated to improve the performance of the shading system. This attempt offered a modicum of reduction in heating loads in colder months (Figure 17) but presented

FIGURE 16. Comparison of solar radiation-ST04.

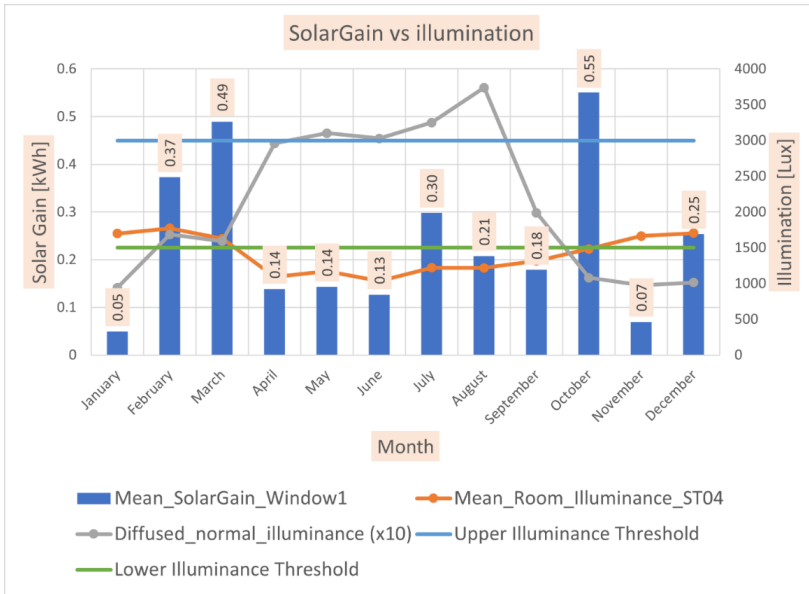
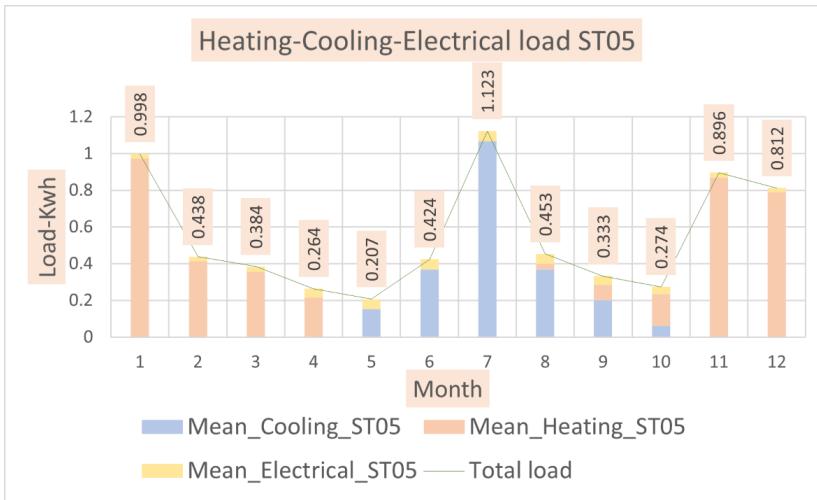

FIGURE 17. Heating-Cooling-Electrical load ST05.



no significant improvements otherwise. It would seem that this strategy is not the optimal option for this building, but there is room for improvement, especially in terms of geometry and automation.

3.2.2 Comparing Performances

3.2.2.1 Cooling Load In Different Strategies

We compared the cooling load (Figure 19), heating load (Figure 20), and electrical lighting load (Figure 21) and then all together (Figure 22) for all five strategies. We selected the desired illuminance of 150 lux for the electrical lighting as the threshold for office desk work with

FIGURE 18. Comparison of solar radiation-ST05.

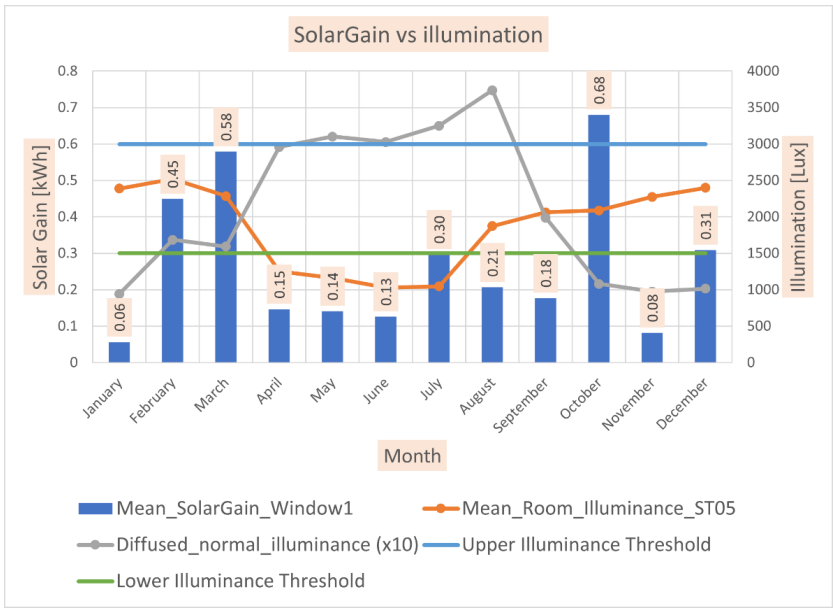

computers (de Vries, Souman et al. 2020). The comparison of the loads (Figure 22) indicates minor improvements. Of note, adding multi-sectional dynamic shading in both internal and external shading parts did not impose any additional thermal loads on the room. This suggests that there may be an opportunity to optimize the geometrical aspects of the shading system to improve its efficiency.

3.2.2.2 Illuminance In Different Strategies

The overall performances of the strategies are compared in terms of Useful Daylight Illuminance (UDI) and Glare Probability. A 150 to 1500 average lux range is defined as useful illuminance for each hour simulated. Average illuminance for each hour over 3000 lux is defined as probable glare (see section “Dynamic internal roller blinds properties”).

FIGURE 19. Comparison of cooling load in 5 strategies.

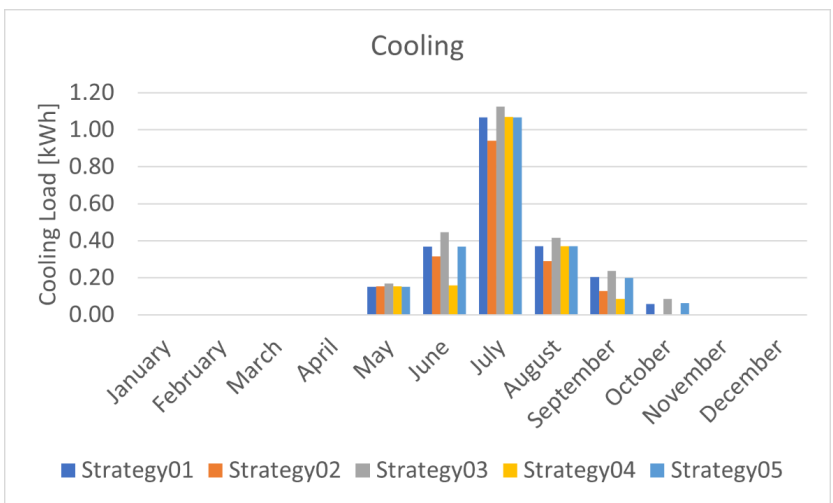

FIGURE 20. Comparison of heating load in 5 strategies.**FIGURE 21.** Comparison of electrical lighting load in 5 strategies.

Figure 23 indicates the monthly performance of each strategy and an overall annual value to be compared. The goal is a maximum annual UDI_d (Useful daylight illuminance with user default threshold) and a minimum annual glare probability (Figure 24). The second strategy in terms of glare probability and the third strategy in UDI outperform the rest of the strategies in most months. However, the fifth strategy has the most consistently acceptable performance for both illuminance and glare. Thus, considering both the energy and illumination performance of all strategies, the fifth strategy is acceptable to be optimized further in this study.

3.2.3 Selected Strategy for Case Study

Based on the assessments visualized above, each strategy indicates the capacity of the rolling blinds and Venetian blinds implemented either as static or dynamic instruments. It is notable

FIGURE 22. Comparison of total load in 5 strategies.

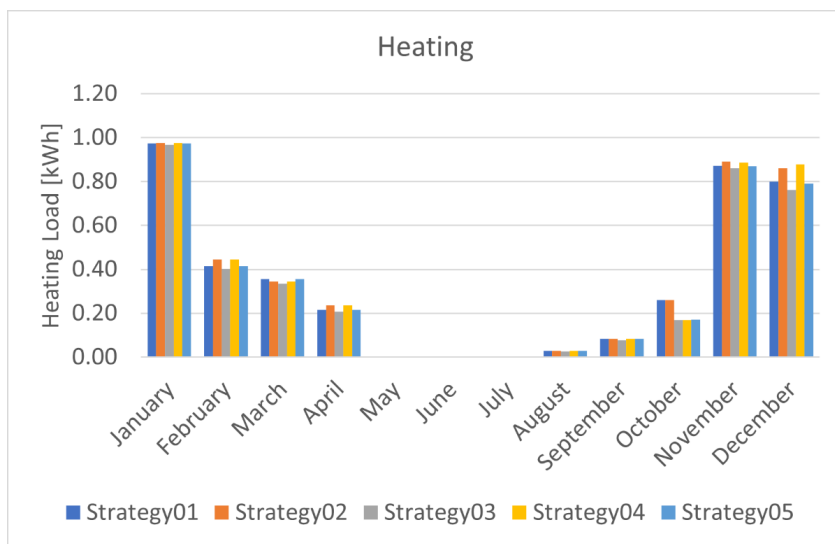
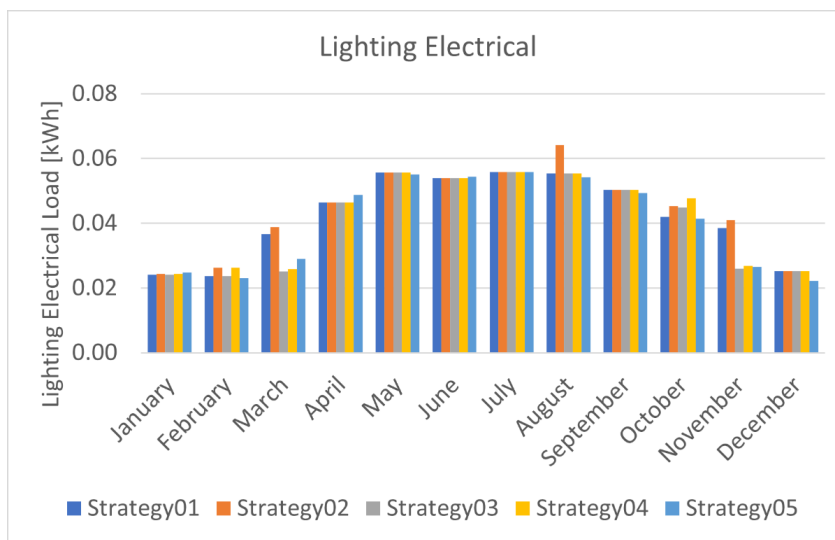
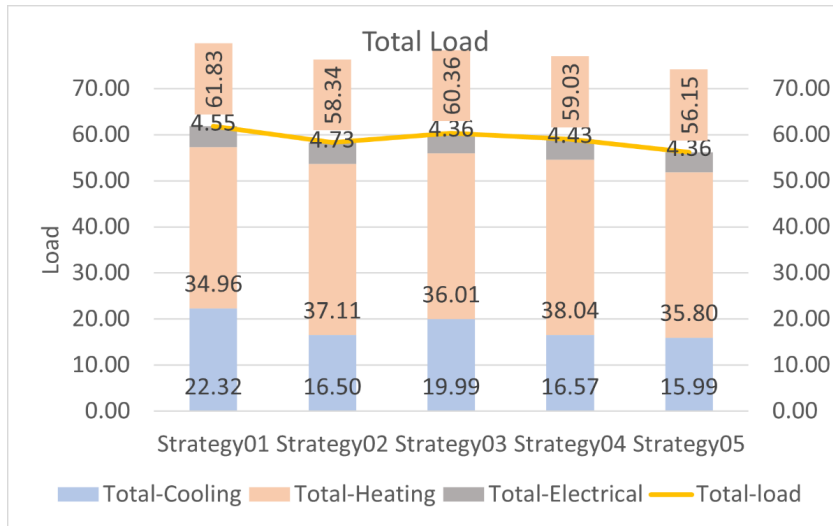
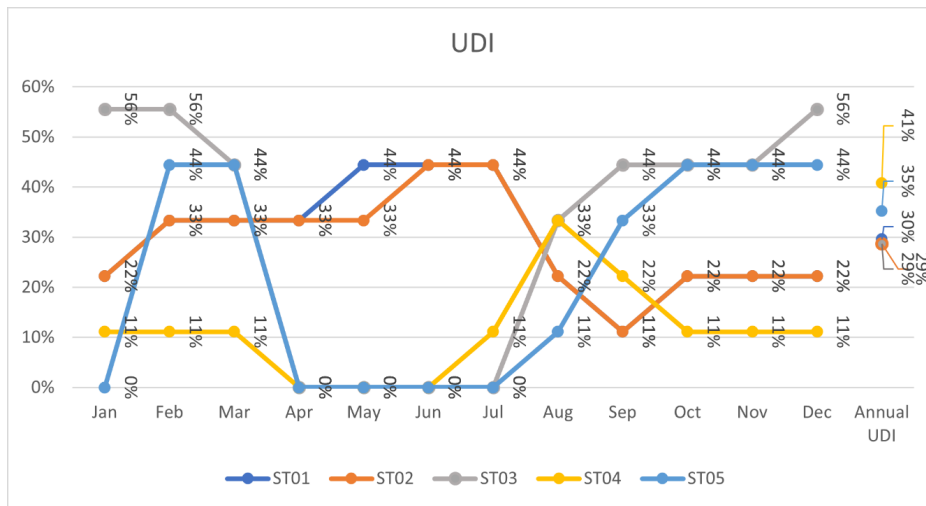

FIGURE 23. Daylight Illuminance performance in 5 strategies.



that dynamically implementing both instruments enable the designer to further improve the performance with the possibility of automation. A configuration of fully dynamic external Venetian blinds and internal roller blinds has a slight impact on improving the room’s visual and thermal performance. Thus, a fully dynamic system is selected to be utilized in the subsequent phases to improve the system further.

3.3 Phase 2—Global Optimization of Shading Geometrical Properties

There are several potential methods for selecting the best design based on defined objectives. Multi-objective Optimization (MOO) is a process of multiple iterations refined through an algorithm to deliver the optimal result. Wallacej, a MOO evolutionary solver plugin that uses the NSGA II algorithm (Makki, Showkatbakhsh et al. 2019) as the basis of its calculation,

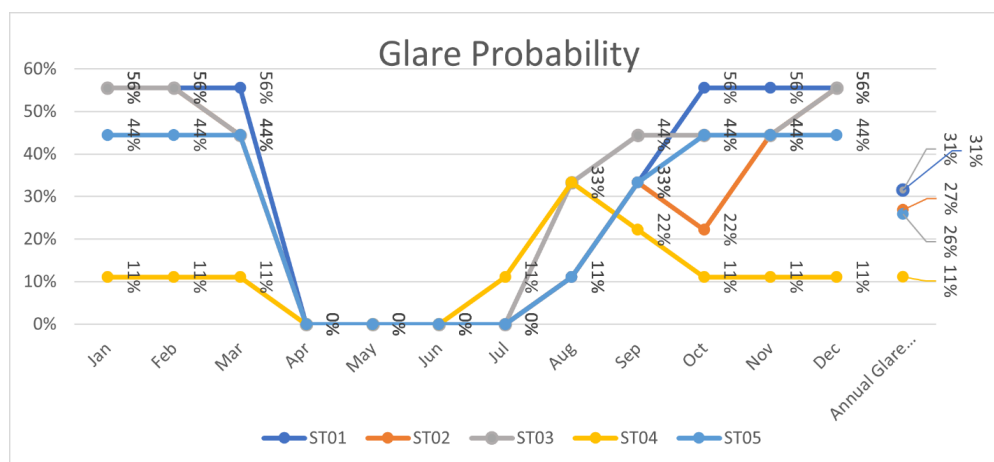
FIGURE 24. Glare probability in 5 strategies.

is used in this project. NSGA-II stands for “Non-dominated Sorting Genetic Algorithm II.” It is a widely used multi-objective optimization algorithm developed by Kalyanmoy Deb in 2002. NSGA-II is a genetic algorithm-based optimization algorithm used to solve problems with multiple objectives. It uses a non-dominated sorting approach to find the Pareto optimal solutions, which are the optimal solutions that cannot be improved in one objective without worsening the other objectives. Wallacei plugin enabled us to use this algorithm in the Rhino Grasshopper environment. This was essential considering the nature of this project since there are few other means to perform iterative simulation of daylighting and building loads based on geometrical iterations of shadings on an opening of the building.

Parameters in Wallacei represent the “genes,” which correspond to combinations of sliders controlling the shading geometry properties. Loads and daylighting results of design combinations are the “objectives,” which are the values to compare in this algorithm. A pool of genes (population) is generated and adjusted to achieve the optimal simultaneous fitness value of the objectives. MOO is used for achieving optimal decisions due to the trade-offs between objectives that may conflict. The multi-objective genetic algorithm determines the optimal configuration for dynamic shading systems.

The variables of dynamic shading design that contribute to the most variance of daylight and energy performance in the external shading include Venetian height, count, and width. In the case of an internal roller, it is the visible transmittance. All the variables are considered

TABLE 3. The variables of dynamic shading design.

Variable	Genome Code
Roller VT	0
Width	1
Venetian height	2
Count	3

TABLE 4. Input magnitude of the variables of dynamic shading design.

Variable Genome Code	Count	Venetian height	Width	Roller VT
0	4	0.5	0.08	0.3
1	6	0.7	0.12	0.45
2	8	0.9	0.16	0.6
3	10	1	0.2	0.75

significant in the model based on the five objectives defined in the optimization, including Cooling, Electricity, Glare, Heating, Illuminance in the first step. In the second step, primary energy, glare, and illuminance are used to find the best design solution.

3.3.1 Genes

Genes are made up of a combination of four variables (Figure 25): Roller blind visible transmittance, Venetian singular slat width, the number of Venetian slats, and the overall height of the section of the window that is covered by Venetian blinds. The visible transmittance of the roller blinds is tested in a range from 30% to 75% with 15% intervals. The visible transmittance is particularly important because even though roller blinds come into effect when there is a need to control glare, they cannot hinder useful daylight illuminance.

3.3.2 Optimization Objectives

The initial optimization phase selects the five objectives: cooling load, heating load, electrical lighting load, useful daylight illuminance, and the number of probable glare hours of the space under study. The first three represent energy performance, while glare and useful illuminance focus on effective daylighting. The objectives in the second optimization phase are primary energy, UDI_d , and probable glare hours. Using these objectives, we try to reach the optimal geometrical dimensions of this shading system.

The generation size (how many individuals per generation) is 20, and the generation count (how many generations in the simulation) is 100 for this simulation. In the first step of the optimization analysis, five objectives are defined. The effect of the different population scenarios on each objective is represented on a parallel coordinator plot (Figure 26).

In Table 8 the algorithm parameter inputs are represented. Crossover probability is defined as the percentage of the solutions in the generation that will reproduce for the next generation and can take a value from zero to one. In our case, 0.9 is chosen to keep the algorithm's global search capability (Poli and Langdon 1998). Mutation probability is defined as the percentage of mutations taking place in the generation. (Deb, Pratap et al. 2002) recommend that the mutation probability is to be $1/n$, where 'n' is the number of variables (sliders) in the design problem. As such, the default value is $1/n$. The crossover and mutation distribution indices control the probability of creating offspring near parent solutions. A small distribution index value allows distant solutions to be selected as children solutions. Conversely, a large distribution index value gives a higher probability of creating offspring near the parent solution. In our case, since the distinction between solutions is of more significance, an index value of 20 is chosen for both crossover distribution and mutation distribution indices.

FIGURE 25. Genes are a combination of four variables.

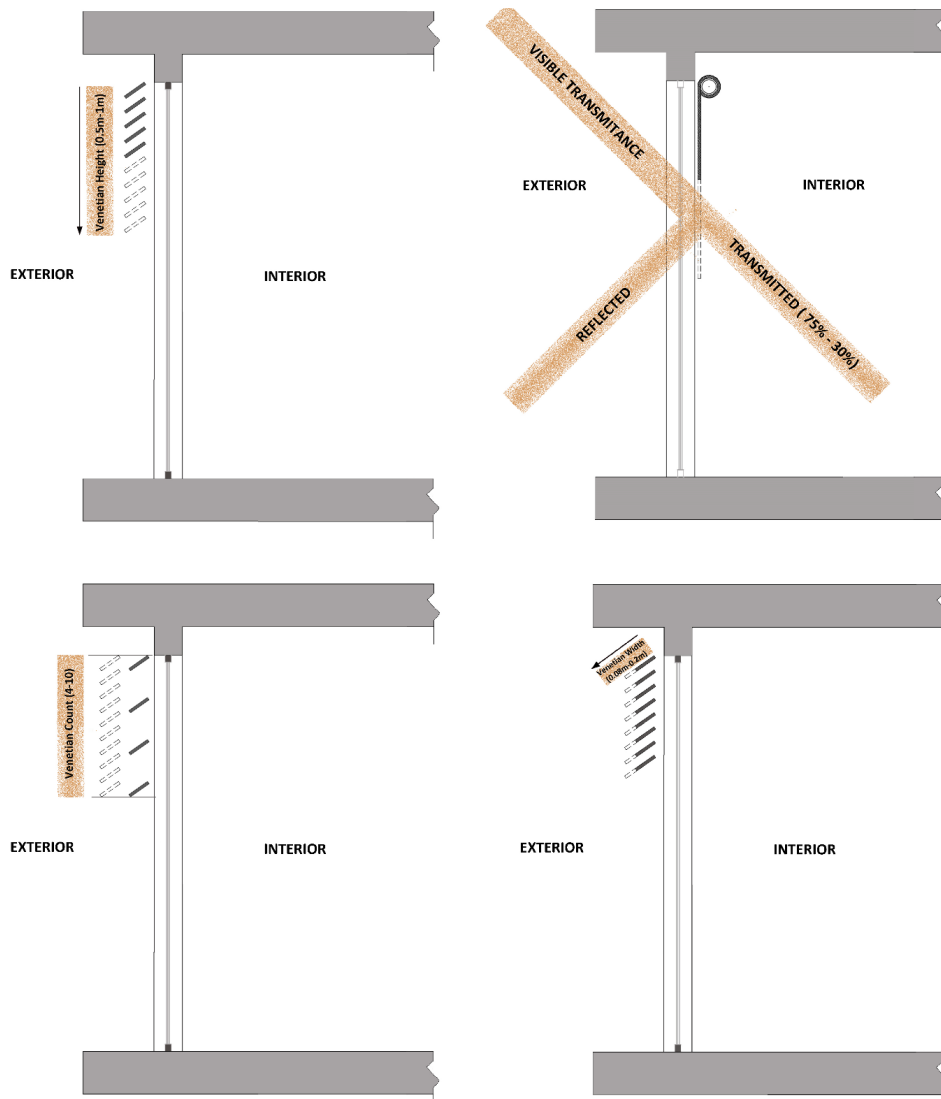

TABLE 5. Five objectives are defined in the optimization.

Genome Code	Variable code
Cooling	1
Electrical	2
Glare	3
Heating	4
Illuminance	5

TABLE 6. Three objectives are defined in the best design solution.

Genome Code	Variable code
Glare	1
Illuminance	2
Primary-Energy	3

TABLE 7. Primary energy indexes.

Primary energy index	Load type
2.5	Cooling
1.1	Heating
2.5	Electrical

TABLE 8. Algorithm parameters.

Parameter	Input
Crossover Probability	0.9
Mutation Probability	1/n
Crossover Distribution Index	20
Mutation Distribution Index	20
Random seed	1

4. RESULTS AND DISCUSSION

Selection of the best geometrical configuration of the shading devices is conducted using the multi-objective optimization method NSGA II evolutionary multi-objective optimization. We utilize a Pareto front solution between possible configurations based on our stated objectives (Table 3, Table 4, Table 5, Table 6, and Table 7).

Initially, five objectives (Table 5) are considered in the optimization process. In Figure 26, the optimization process is not converging. This lack of convergence is better illustrated if we look at the Pareto front solutions among all generations (Figure 27).

A comparison between the last five generations, 5 out of 20 Pareto front solutions, clearly indicates that solutions reached through this analysis cannot be trusted as a globally optimized solution (Figure 28).

Another figure signaling concern in this solution is comparing the best ranked average fitness generation (Figure 29). Fitness generation refers to the solution with the closest ranking among its objectives and the chosen Pareto front solution. Figure 30 illustrates each objective's ranking of the best ranked average fitness solution and the chosen Pareto front solution

FIGURE 26. Fitness ranking chart of all the generations. Generation sequence is shown starting with light pink ending in dark blue. Objectives: F01. Cooling, F02. Electrical, F03. Glare, F04. Heating, F05. Illuminance.

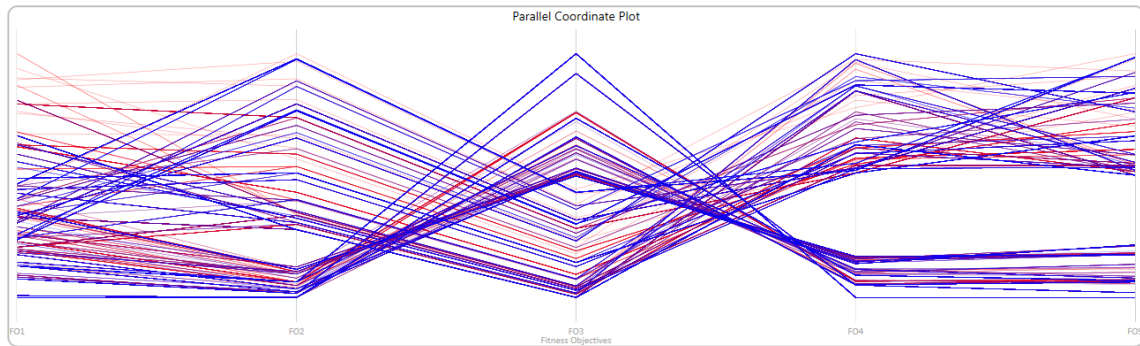
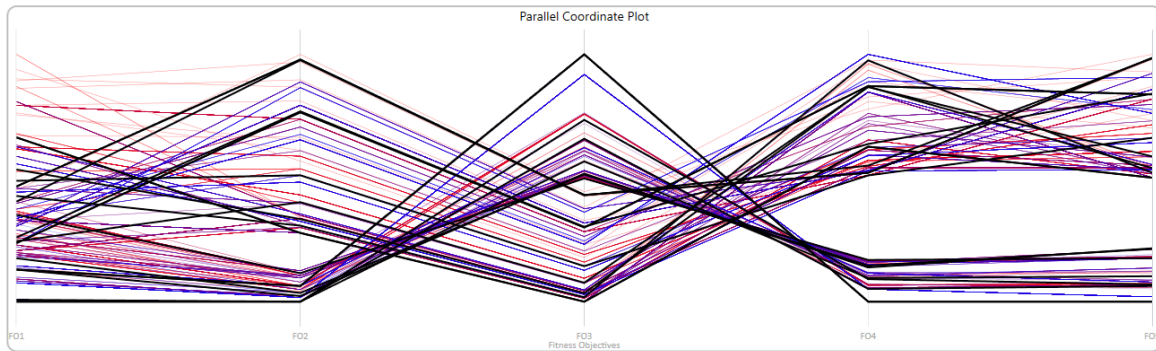

FIGURE 27. Pareto front solutions (black lines) fitness ranking chart. Generation sequence is shown starting with light pink ending in dark blue. Objectives: F01. Cooling, F02. Electrical, F03. Glare, F04. Heating, F05. Illuminance.



side-by-side. It shows that our initially chosen Pareto front from the not-converged solutions, is showing weaker performance compared to the best ranked average fitness solution in most objectives.

In a second effort, we transformed all the energy-related objectives into one primary-energy-based objective using their primary energy index (Table 7). This three-objective optimization successfully converged (Figure 31). It shows the Pareto front solutions in the fitness value chart, indicating much less variation between objectives in each solution and mostly close to zero fitness rankings.

The results are even better represented in a comparison chart between the last five generations of this optimization process. A much smaller area under the spider chart, coupled with much more similarity among the fitness ranking of the Pareto front solutions, reassures us that whichever solution among these Pareto fronts chosen has a good chance of being close enough to the global minimum to be an acceptable choice (Figure 33).

The uniformity between the best ranked average fitness solution (Figure 34) and the chosen Pareto front solution (Figure 35) confirms the optimal choice for the selected method.

FIGURE 28. Comparison between last five genomes generated in five-objective optimization.

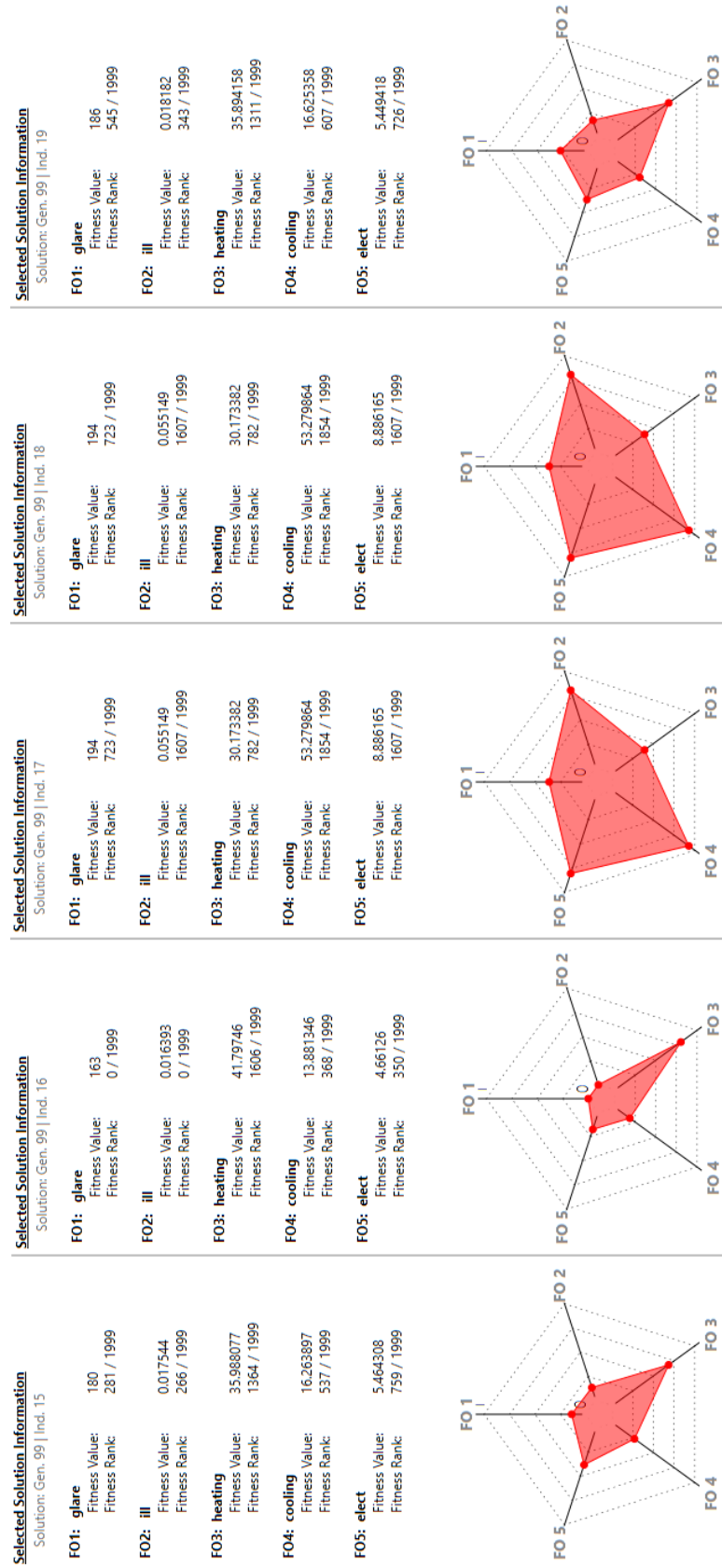

FIGURE 29. Five-objective optimization, best ranked average fitness solution on PCP diagram.

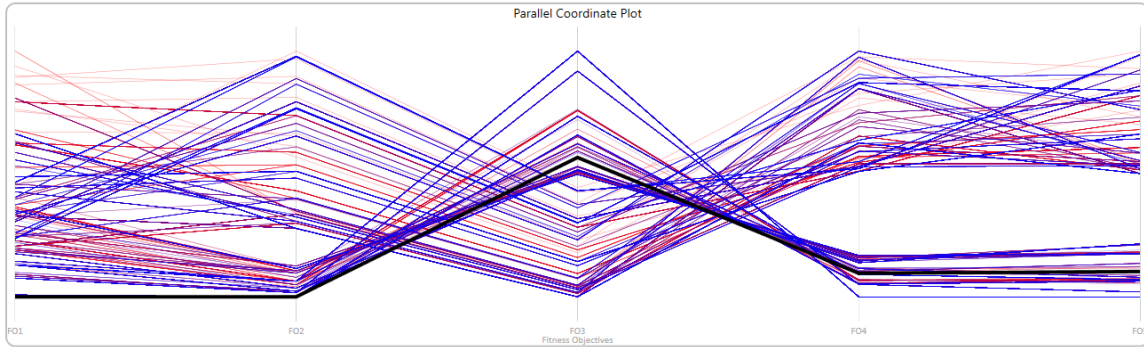

FIGURE 30. Five-objective optimization, best ranked average fitness solution vs. chosen Pareto front solution.

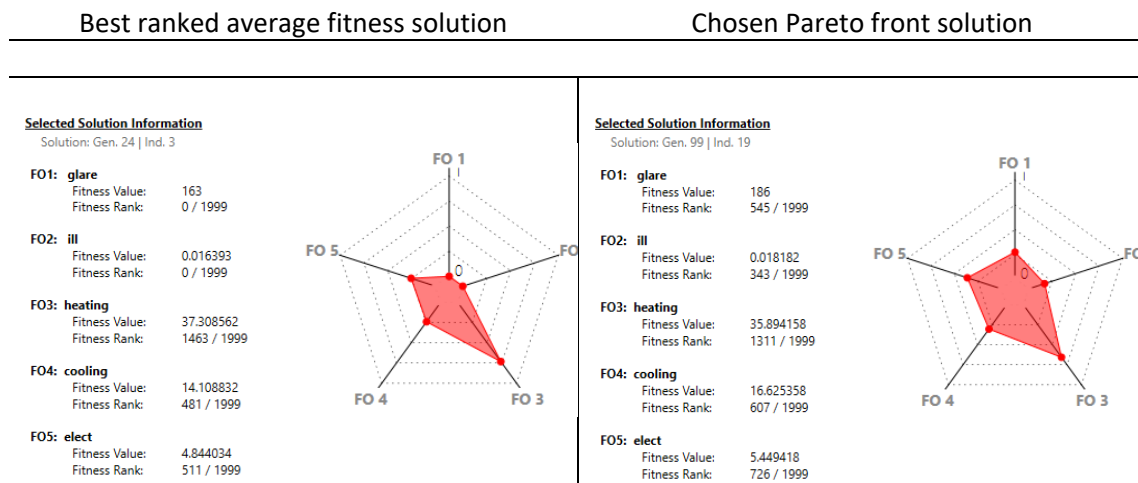

FIGURE 31. Fitness ranking chart of all the generations. Generation sequence is shown starting with light pink ending in dark blue. Objectives: F01. Glare, F02. Illuminance, F03. Primary Energy.

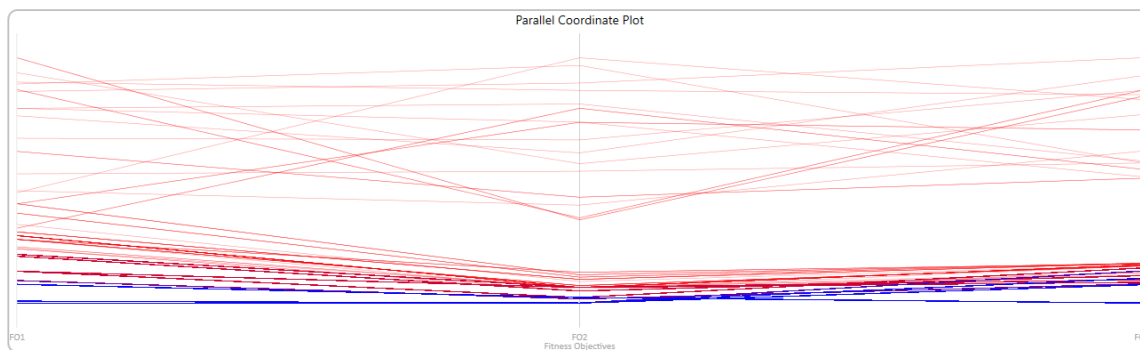
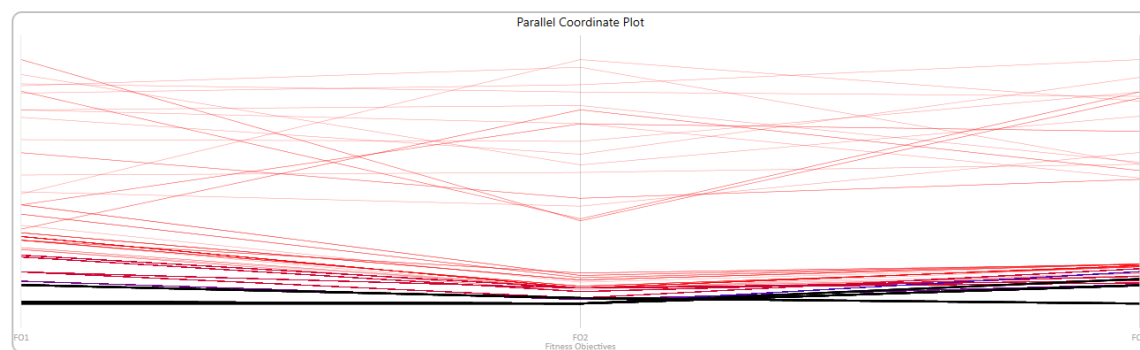

FIGURE 32. Pareto front solutions (black lines) fitness ranking chart. Generation sequence is shown starting with light pink ending in dark blue. Objectives: F01. Glare, F02. Illuminance, F03. Primary Energy.



4.1 Selection Of Solution

Finally, using both the Average Fitness Rank method used by analyzing the parallel coordinate plot (PCP) and Pareto front solutions reached by the algorithm, the following genome solution is selected and decoded. The selected solution has a roller blind visible transparency of 45% and eight Venetian slats with 16cm width for each window with a 90cm height from the topmost slat pin to the bottom one. This configuration provides the best illuminance and lowest energy consumption in the room compared to the other possible configurations.

4.2 Future Work

In design, there are a wide variety of factors and confounding events that will influence the performance of a strategy. There is always room for optimization, and optimization itself is dynamic. One aspect that can help us improve design performance is automating the system to reflect these dynamics, such as environmental conditions and user behavior and needs.

In future work, a digital twin model can be developed to help track how performance levels change and interact. It can consider data received from sensors indicating the current condition

FIGURE 33. Comparison between last five genomes generated in three-objective optimization.

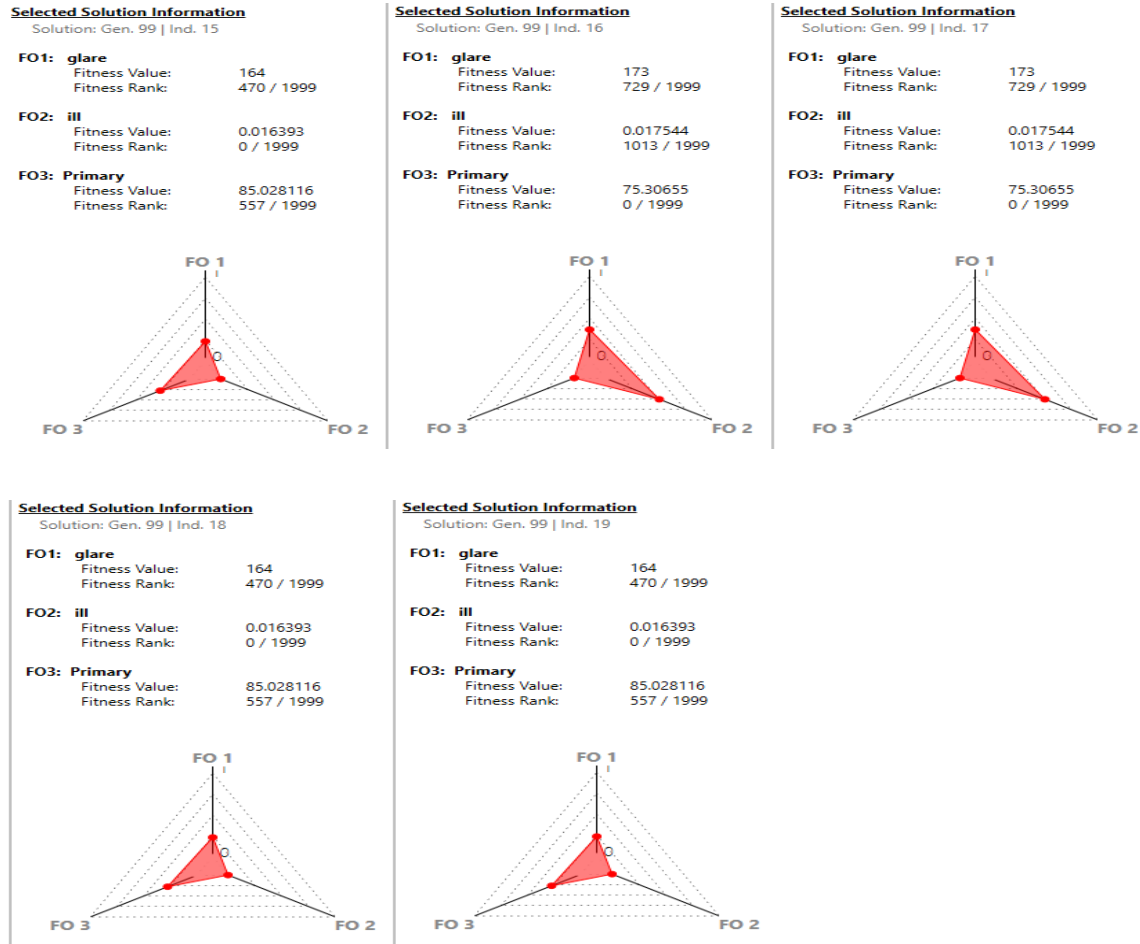

FIGURE 34. Three-objective optimization, best ranked average fitness solution on PCP diagram.

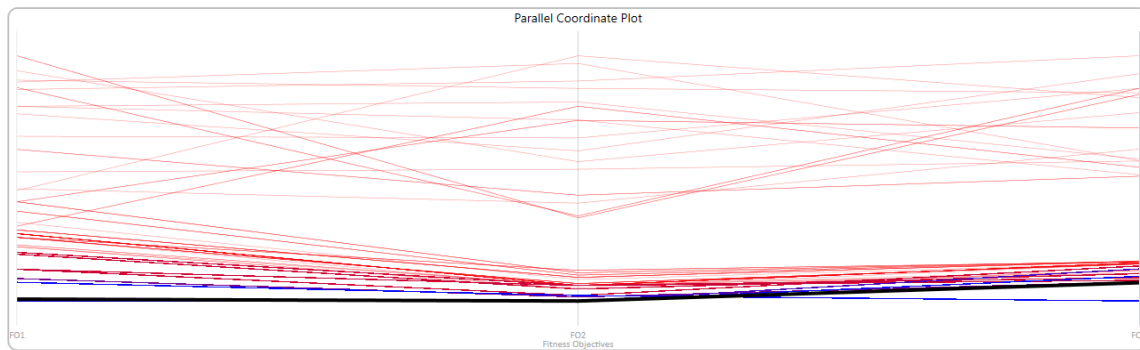

FIGURE 35. Three-objective optimization, best ranked average fitness solution vs. chosen Pareto front solution.

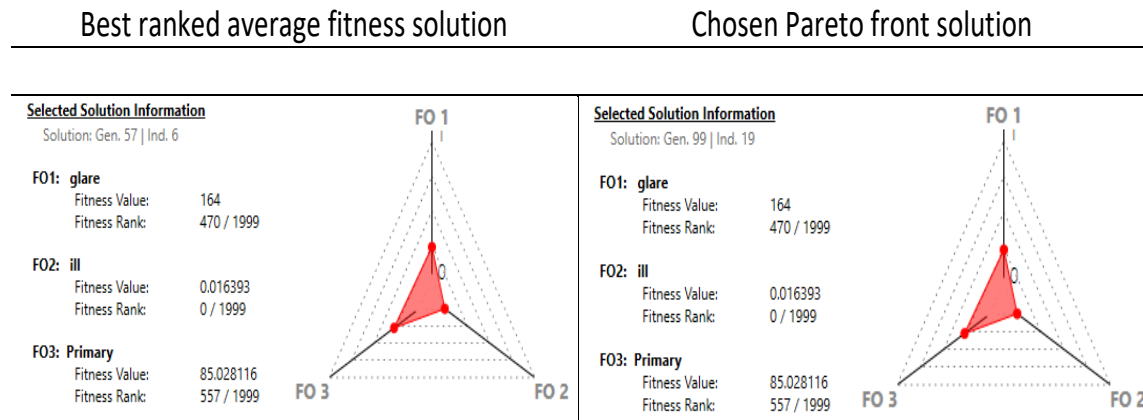

TABLE 9. The Genome decodes of the selected solution.

Generation: 9 Individual: 151 Genome Decode	1222
Roller VT	0.45
Width	0.16
Venetian height	0.9
Count	8

of the space and user preferences and behavior, coupled with machine learning techniques to program the system to achieve high-performance levels.

5. CONCLUSION

This study has undertaken a vital exploration into the optimization of building envelope efficiency through intelligent shading systems, with specific focus on home-office settings—an avenue magnified in significance by the prevailing trend of remote work. Building upon existing scholarship and addressing identified gaps, the study introduced genetic algorithms and machine learning methodologies as pioneering analytical frameworks for designing shading systems.

In the first phase of our research, five strategies of dynamic and static configuration of shading systems were explored, with the emphasis on heating, cooling, electrical loads, UDI, and glare probability. The findings underscored the potential of a fully dynamic shading system

TABLE 10. Optimization genes and objectives.

Genes	Genome code	Objectives I	Reference no.	Objectives II	Reference no.
Roller VT	0	Cooling	0	Glare	0
Width	1	Electrical	1	UDI _d	1
Venetian height	2	Glare	2	Primary-Energy	2
Count	3	Heating	3		
		UDI _d	4		

to provide optimal performance objectives, particularly when further optimized in geometrical attributes and automation strategy.

The second phase was marked by a concerted effort to optimize these geometrical attributes, employing an evolutionary multi-objective optimization method tailored to the unique demands of home-office settings. We scrutinized the Venetian slat width, the number of slats, and the total window height covered by blinds, alongside the roller blinds' fabric visible transmittance. The optimization focused on energy considerations, including heating, cooling, electrical loads, and UDI, culminating in primary energy UDI and probable glare point-hours (Table 10).

While the optimization process did not yield a single solution, it narrowed the design problem to three analogous outcomes. Even though the simulations were performed on a comparative basis without covering the entire solar year, the study inferred the power of multi-objective optimization in achieving optimal geometrical features of the shading system.

Our findings resonate with the broader imperatives of environmental responsibility and the global energy crisis, emphasizing that the intelligent design of shading systems not only fosters energy conservation but enhances occupant comfort. The study's utilization of global optimization methods, tested within the context of a specific home office in Lecco, Italy, holds promise for widespread application in diverse climate scenarios.

Moreover, the possibilities for further research are manifold. The potential for performance improvement by introducing automation systems and machine learning techniques stands out as a pertinent future direction. This could embrace dynamic conditions and user-specific needs, advancing the design performance further, aligned with the United Nations' sustainable development goals.

In summation, as the trajectory of remote work continues to shape our built environment, this study contributes valuable insights for the design of sustainable and comfortable home-office spaces. By innovatively leveraging simulation tools and optimization techniques, the research strikes a harmonious balance between energy efficiency and occupant well-being, offering a blueprint for modern work culture in the ever-evolving landscape of architectural engineering. Data Availability Statements

Some or all data, models, or code that support the findings of this study are available from the corresponding author upon reasonable request. (List items.)

ACKNOWLEDGEMENTS

This project is supported through the National Science Foundation grant no. 2035176, USA.

REFERENCES

- Abdelwahab, S. and H. Sobh (2022). "Visual Discomfort Analysis as a Tool to Support Façade Shading Design: A Case Study in the Architectural Design Studio." *Journal of Architectural Engineering* **28**(2): 05022003.
- Al-Tamimi, N. A. and S. F. S. Fadzil (2011). "The potential of shading devices for temperature reduction in high-rise residential buildings in the tropics." *Procedia Engineering* **21**: 273–282.
- Alotaibi, F. (2015). "The role of kinetic envelopes to improve energy performance in buildings." *Journal of Architectural Engineering Technology* **4**(3): 149–153.
- Bragança, L., et al. (2014). "Early stage design decisions: the way to achieve sustainable buildings at lower costs." *The scientific world journal* **2014**.
- Bunz, K. R., et al. (2006). "Survey of sustainable building design practices in North America, Europe, and Asia." *Journal of Architectural Engineering* **12**(1): 33–62.
- Chan, Y.-C. and A. Tzempelikos (2015). "Daylighting and energy analysis of multi-sectional facades." *Energy Procedia* **78**: 189–194.
- Climate-Data.org (2023). "LECCO CLIMATE (ITALY)." Retrieved Aug 21, 2023, from <https://en.climate-data.org/europe/italy/lombardy/lecco-1099/>.
- climate, w. (2023). "Climate in Lecco (Lombardy, Italy)." Retrieved Aug 21, 2023, from <https://weather-and-climate.com/average-monthly-Rainfall-Temperature-Sunshine,lecco-lombardy-it,Italy>.
- De Rosa, M., et al. (2015). "Historical trends and current state of heating and cooling degree days in Italy." *Energy conversion and management* **90**: 323–335.
- de Vries, A., et al. (2020). "Teasing apart office illumination: Isolating the effects of task illuminance on office workers." *Lighting Research & Technology* **52**(8): 944–958.
- Deb, K., et al. (2002). "A fast and elitist multiobjective genetic algorithm: NSGA-II." *IEEE transactions on evolutionary computation* **6**(2): 182–197.
- Do, C. T. and Y.-C. Chan (2020). "Evaluation of the effectiveness of a multi-sectional facade with Venetian blinds and roller shades with automated shading control strategies." *Solar Energy* **212**: 241–257.
- Janssen, R. (2004). "Towards energy efficient buildings in Europe." *London: The European Alliance of Companies for Energy Efficiency in Buildings*.
- Korkmaz, S., et al. (2010). "High-performance green building design process modeling and integrated use of visualization tools." *Journal of Architectural Engineering* **16**(1): 37–45.
- Lakhdari, K., et al. (2021). "Parametric optimization of daylight, thermal and energy performance of middle school classrooms, case of hot and dry regions." *Building and Environment* **204**: 108173.
- Lin, P.-H., et al. (2008). "Effects of anti-glare surface treatment, ambient illumination and bending curvature on legibility and visual fatigue of electronic papers." *Displays* **29**(1): 25–32.
- Makki, M., et al. (2019). Wallacei Primer 2.0, [Online]. Tratto da www.wallacei.com.
- Manzan, M. (2014). "Genetic optimization of external fixed shading devices." *Energy and Buildings* **72**: 431–440.
- Mardaljevic, J. (1999). *Daylight simulation: validation, sky models and daylight coefficients*, De Montfort University Leicester.
- Mardaljevic, J. (2006). *Examples of climate-based daylight modelling*. CIBSE national conference, Citeseer.
- Moghtadernejad, S., et al. (2019). "Facade design stages: issues and considerations." *Journal of Architectural Engineering* **25**(1): 04018033.
- Nicol, F., et al. (2006). "Using field measurements of desktop illuminance in European offices to investigate its dependence on outdoor conditions and its effect on occupant satisfaction, and the use of lights and blinds." *Energy and Buildings* **38**(7): 802–813.
- Pesenti, M., et al. (2018). "Exploration of adaptive origami shading concepts through integrated dynamic simulations." *Journal of Architectural Engineering* **24**(4): 04018022.
- Poli, R. and W. B. Langdon (1998). "On the search properties of different crossover operators in genetic programming." *Genetic Programming*: 293–301.
- Reinhart, C. F. and O. Walkenhorst (2001). "Validation of dynamic RADIANCE-based daylight simulations for a test office with external blinds." *Energy and Buildings* **33**(7): 683–697.

- Roulet, C.-A. (2001). "Indoor environment quality in buildings and its impact on outdoor environment." *Energy and Buildings* **33**(3): 183–191.
- Spark, W. (2023). "Climate and Average Weather Year Round in Lecco Italy." Retrieved Aug 21, 2023, from <https://weatherspark.com/y/62582/Average-Weather-in-Lecco-Italy-Year-Round>.
- United Nations Environment Programme (2020). 2020 Global Status Report for Buildings and Construction: Towards a zero-emissions, efficient and resilient buildings and construction sector.
- Wienold, J. and J. Christoffersen (2006). "Evaluation methods and development of a new glare prediction model for daylight environments with the use of CCD cameras." *Energy and Buildings* **38**(7): 743–757.

