

Parametric as-built model generation of complex shapes from point clouds

Luigi Barazzetti

Politecnico di Milano, Department of Architecture, Built Environment and Construction Engineering, Via Ponzio 31, 20133 Milan, Italy

ABSTRACT

This paper presents a novel semi-automated method for the generation of 3D parametric as-built models from point clouds. Laser scanning and photogrammetry have a primary role in the survey of existing facilities, especially for the generation of accurate and detailed as-built parametric models that reflect the true condition of a building. Various studies demonstrate that point clouds have a sporadic adoption in large and complex parametric modeling projects. The lack of advanced processing algorithms able to convert point clouds into parametric objects makes the generation of accurate as-built models a challenging task for irregular elements without predefined shape.

The proposed semi-automated method allows the creation of parametric models from photogrammetric and laser scanning point clouds. The method is intended as a multi-step process where NURBS curves and surfaces are used to reconstruct complex and irregular objects, without excessive simplification of the information encapsulated into huge point clouds to avoid heavy models useless for practical purposes and productive work. Different case studies derived from actual BIM-based projects are illustrated and discussed to demonstrate advantages and limitations of the method.

Keywords:

As-built
Automation
Laser scanning
Parametrization
Photogrammetry
Point cloud

1. Introduction

The generation of accurate as-built parametric models of objects surveyed with point clouds is a complex task of primary importance in reuse projects of existing buildings [41]. Laser scanning and photogrammetric point clouds provide a huge amount of metric information that reveals the actual shape. However, point clouds have to be turned into useful models for the different specialists (architects, engineers, restorers, etc.) involved in the project.

Direct geometric modeling is the process of creating static 3D models with both simple and complex surfaces. On the other hand, the use of Building Information Modeling is becoming more important for construction, renovation, reuse and management projects. Here, the static representation offered by direct geometric modeling is not sufficient. *Parametric modeling* can be intended as the process of “redrawing without redrawing”. If (direct) geometric modeling aims at providing a static reconstruction of the objects, in parametric modeling distinct objects can be interactively modified by changing the numerical values in a set of predefined parameters stored in a database (Fig. 1).

According to Eastman et al. [16, Chapter 1], parametric objects (i) contain geometric information and associated data and rules, (ii) have non-redundant geometry, which allows for no inconsistencies, (iii) have parametric rules that automatically modify associated geometries when inserted into a building model or when changes are made to associated objects, (iv) can be defined at different levels of aggregation, and (v) have the ability to link to or receive, broadcast, or export sets of attributes such as structural materials, acoustic data, energy data, and cost, to other applications and models. Parametric modeling refers to a virtual construction with fully-defined objects that know where they belong, how they relate to other objects and what they consist of [43].

Automated reconstruction of indoor scenes from point clouds has a direct connection to parametric modeling. Nowadays, 3D indoor modeling in real construction projects is mainly a manual procedure, that is time consuming and labor intensive [27]. Automated algorithms assume that the scene is composed of several primitive such as planar parts and arbitrarily shaped clutters [32]. As mentioned, automated algorithms have a strong connection to as-built parametric modeling strategies for the need of planar shapes detected with robust data processing algorithms [11], i.e. automated procedures able to detect wall segments and remove outliers. Volumetric modeling approaches were also

E-mail address: luigi.barazzetti@polimi.it

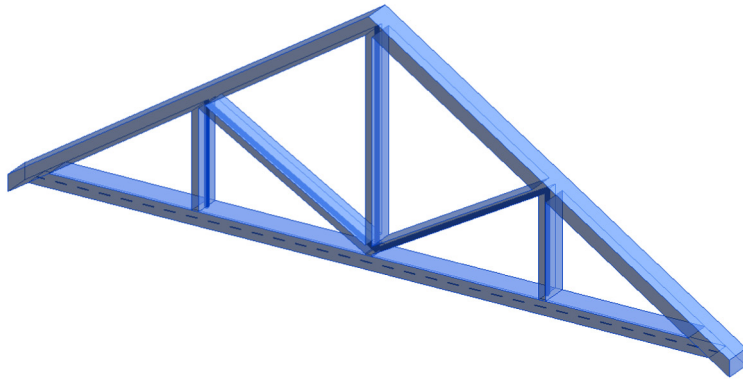
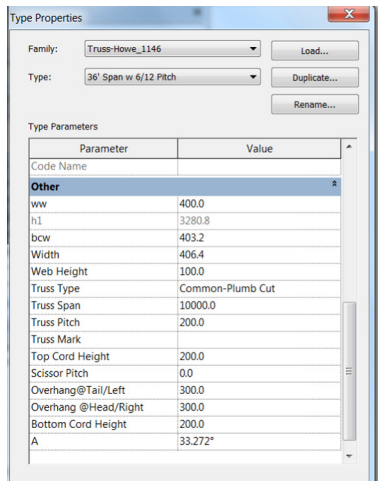

Fig. 1. In parametric modeling a database is associated to the different elements of the objects: the elements of the truss can be modified by changing the numerical values in the table.

proposed by Oesau et al. [33] to deal with multi-level buildings with arbitrary wall directions.

In recent years, parametric modeling has gathered more attention for the increasing demand of Building Information Modeling (BIM) in construction projects worldwide [9,46]. BIM relies on a 3D model made of objects with a rich set of attributes stored in a database. Objects are defined as parametric objects with relationships to other parametric objects. The 3D model is not only a static representation of the facility, but also an advanced computer technology to manage information for the automatic generation of drawings (sections, plans, etc.) and reports, design analysis, schedule simulation, thermal and structural simulation, facilities management, and much more. Although *as-designed* BIM (i.e. BIM generated in the design phase of a facility) has reached a sufficient maturity for practical purposes, *as-built* BIM generation (i.e. BIM of existing facilities generated from a preliminary survey, see Fig. 1) is still a challenging task where it is difficult to capture, interpret and represent as-built conditions in a complete BIM workflow [6,18,38]. As-built BIM refers to BIM of existing buildings where an as-designed BIM could be also available (“as-built” means “as-is”). In other words, it reflects the real conditions of the construction, which could be different than those reported in the as-designed BIM or existing drawings [42].

In the design stage of a facility, architectural, engineering and technical issues are analyzed in common workflow to arrive at the global definition of the construction process. Numerous researchers have explored the potential offered by integrated 3D modeling instead of a more traditional 2D design. The advantages of BIM technology can also be exploited for existing buildings [1,45]. The use of existing drawings (including CAD) to generate the as-built BIM can be a source of errors in the case of variation orders during the construction phase, which is a common problem in construction projects [23,31]. Only a detailed survey of existing buildings can reveal the actual shape of the structures, which can differ from the designed form because of local anomalies, degradations and damages.

Photogrammetry and laser scanning technology are rapid and accurate measurement techniques that can support the generation of as-built BIM. Both provide dense point clouds with millimeter level accuracy, revealing the real external shape of constructive elements. However, few commercial BIM packages can read and display point clouds (e.g. Autodesk Revit and AECOSim Building Designer) to facilitate the integration of point clouds and BIM objects. Some new plugins are able to improve the interactive

(manual) creation of BIM objects of simple elements, such as regular walls and columns, as well as Mechanical Electrical Plumbing (MEP) elements (e.g. pipes and conduits).

Automatic as-built BIM generation refers to the creation of BIM objects from sets of raw point clouds registered in a common reference system [8,21], including information from existing reports, analysis on materials, destructive and non-destructive tests, infrared thermography, etc. Fully automatic as-built BIM generation is still in its infancy and as-built BIM are usually produced with manual measurements, making the whole process time-consuming and error-prone. According to Nagel et al. [30], automatic reconstruction of buildings has been a research issue over the last 25 years with little success to date. They point out that the main issues for a complete automation of the workflow are related to the def-inition of a target structure that covers all variations of building, the complexity of input data, ambiguities and errors in the data, and the reduction of the search space during interpretation [44]. It is not difficult to understand why fully automatic as-built BIM generation from point clouds is a complicated task. Although laser scanning and photogrammetry are very popular solutions in 3D modeling projects (see for example [5,25,7,12,17,20,13,22]), most 3D modeling techniques available today in commercial and scientific software do not provide BIM models. Mesh surfaces generated from packages for point cloud editing (e.g. Geomagic Studio, Polyworks, 3DReshaper, etc.), image-based software (e.g. PhotoModeler, PhotoScan, 3D Zephyr, Pix4Dmapper, Smart3DCapture, etc.), and advanced 2D or 3D modeling environments (AutoCAD, Rhinoceros, Maya, 3D Studio Max, etc.) are not BIM objects. The geometric fitting of static primitives (e.g. planes, cylinders, etc.) is also a pure geometric process that does not fulfil the basic requirements of BIM projects.

Different BIM software (e.g. Revit, ArchiCAD, AECOSim Building Designer, Tekla BIMsight, etc.) are available on the commercial market and allow users to manually generate as-designed and as-built BIM. Some examples of complete as-built models from point clouds obtained in Revit and ArchiCAD were proposed by Murphy et al. [28], Baik et al. [3], Fai and Rafeiro [19], Oreni et al. [34], Barazzetti et al. [4], Dore et al. [15], and Quattrini et al. [39].

Because existing object libraries were mainly designed for design purposes (i.e. new constructions), the challenges faced in this paper can be described by the following questions: how can we generate an accurate as-built parametric model of irregular elements? Can we take into consideration geometric anomalies with

such irregular objects? Can we preserve the level of detail achievable with dense point clouds? The proposed solution is a semi-automated tool able to simplify the generation of a parametric objects that take into account the geometric complexity. The outcome of this research is a novel tool for parametric modeling (from point clouds) which was already used in productive work, reducing time-consuming operations in manual modeling so that costs can be potentially reduced.

2. The developed solution for parametrization of complex shapes

The implemented solution for parametric as-built object generation (from laser point clouds) is based on NURBS curves and surfaces created in a semi-automated way. The case study used to highlight the importance of separating structural elements is shown in Fig. 2. The complex umbrella vault is located in Castel Masegra (Sondrio, Italy). Ribs have a circular organization that can be reconstructed with manual measurements on the point cloud. This allows a geometric reconstruction that preserves the uniqueness of the structure in terms of both architectural and structural aspects. The proposed approach can be summarized as follows.

- the (human) operator manually extracts the discontinuity lines of constructive elements (Fig. 2b), which are densified with a manual, semi-automated or automated approach, obtaining a dense network of curves (Fig. 2b);
- network and point clouds are used to fit NURBS surfaces (Fig. 2c);
- parametric objects are created to produce an editable volumetric representation (Fig. 2d).

NURBS (Non-Uniform Rational B-Splines) are mathematical functions with a clear geometric representation. NURBS can be computed with numerically stable algorithms, obtaining real-time results [36]. NURBS tools are also available in commercial packages for direct geometric modeling. However, the models generated in these processing environments are not BIM objects, but only static models without parametric representation. On the contrary, BIM software have a lack of tools for managing complex

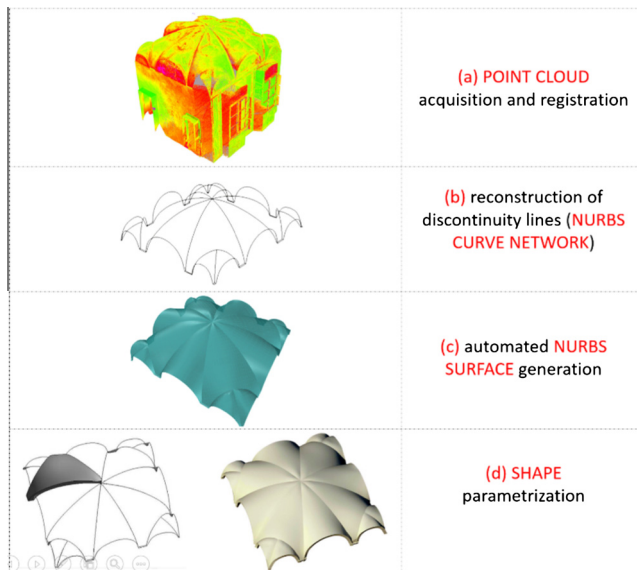

Fig. 2. The proposed workflow for the generation of parametric objects of irregular elements.

shapes surveyed with laser point clouds. The identification and simplification of the logic of construction of different structural elements is fundamental to create parametric objects, that become a detailed representation of the real structure.

2.1. From point clouds to NURBS

The reconstruction begins after the acquisition and registration of a set of point clouds [2], which can be generated with laser scanning or photogrammetric techniques. Then, the (expert) user identifies the different structural objects and their discontinuity lines. This is mandatory in BIM projects where different structural elements must be separated to obtain an object-oriented reconstruction.

The approach for the generation of discontinuity lines is based on NURBS curves. A NURBS curve is a vector-valued piecewise rational polynomial function of the form:

$$\mathbf{C}(u) = \frac{\sum_{i=0}^n N_{i,p}(u) w_i \mathbf{P}_i}{\sum_{i=0}^n N_{i,p}(u) w_i} \quad (1)$$

where $\{w_i\}$ are weights, $\{\mathbf{P}_i\}$ control points, $\{N_{i,p}(u)\}$ are p th-degree B-spline basis functions defined by the recursive Cox-deBoor form:

$$N_{i,0}(u) = \begin{cases} 1 & \text{if } u_i \leq u \leq u_{i+1} \\ 0 & \text{otherwise} \end{cases} \quad (2)$$

$$N_{i,p}(u) = \frac{u - u_i}{u_{i+p} - u_i} N_{i,p-1}(u) + \frac{u_{i+p+1} - u}{u_{i+p+1} - u_{i+1}} N_{i+1,p-1}(u)$$

U is a non-decreasing sequence of real numbers whose elements are called knots, which form a knot vector

$$U = \{0, \dots, 0, u_{p+1}, \dots, u_{m-p-1}, 1, \dots, 1\}$$

NURBS curves can be used to reconstruct standard shapes (lines, circles, parabolas, etc.) or free-form profiles. Post-processing (manipulation) is feasible by means of different strategies like control point translation, change of weight values, knot insertion/removal/refinement, and degree elevation. For these reasons, NURBS are very efficient functions to initialize the interactive part of the reconstruction, which also requires an interpretation of the different structural elements of the building.

The discontinuity lines of the umbrella vault in Fig. 2 were generated by selecting the control points on the point cloud, obtaining a set of NURBS curves of degree 3. This preliminary network of curves provides the boundaries of the vault and follows the logic of construction (how the structural elements is built), which cannot be neglected in the case of object-based projects.

NURBS curves are then used to initialise the generation of NURBS surfaces, which are functions of degree (p, q) in the directions (u, v) defined as:

$$\mathbf{S}(u, v) = \frac{\sum_{i=0}^n \sum_{j=0}^m N_{i,p}(u) N_{j,q}(v) w_{ij} \mathbf{P}_{ij}}{\sum_{i=0}^n \sum_{j=0}^m N_{i,p}(u) N_{j,q}(v) w_{ij}} \quad (3)$$

where $\{w_{ij}\}$ are weights, and $\{N_{i,p}(u)\}$ and $\{N_{j,q}(v)\}$ are B-spline basis functions defined on the knot vectors $U = \{0, \dots, 0, u_{p+1}, \dots, u_{r-p-1}, 1, \dots, 1\}$ and $V = \{0, \dots, 0, v_{q+1}, \dots, v_{s-q-1}, 1, \dots, 1\}$, where $r = n + p + 1$, and $s = m + q + 1$.

NURBS surfaces are very used in the CAD/CAM industry for the opportunity to model simple and complex shapes. Natural quadrics (plane, cylinder, cone, and sphere), general quadrics, extruded surfaces, ruled surfaces and surfaces of revolution are commonly used in design and reconstruction projects. The proposed approach relies on NURBS surfaces generated from a set of curves in space, which are used as geometric constraint for surface interpolation. Although NURBS surfaces can be fitted to an unorganized point cloud, the final representation is usually very poor for sharp

elements with discontinuity lines. The use of a preliminary set of curves for the generation of the surface is a more robust choice to drive the creation of the surface [36].

After the extraction of the principal discontinuity lines, surfaces are generated with a fitting process of the point cloud based on additional constraints given by the curve network. Two methods are used in the proposed workflow. The first one allows a strong control of the surface, which is estimated with an elegant mathematical solution from a dense curve network where the curves in one direction cross all curves in the other direction (self-intersections between curves in the same directions are not allowed). In this case, the reconstruction of the surface surveyed with point clouds is carried out with the NURBS network

$[\mathbf{C}_k(u), \mathbf{C}_l(v)]$, obtaining a final NURBS surface $\mathbf{S}(u, v)$ which interpolates the profiles in space so that $\mathbf{C}_k(u) = \mathbf{S}(u, v_k)$ ($0 \leq k \leq K$) and $\mathbf{C}_l(v) = \mathbf{S}(u_l, v)$ ($0 \leq l \leq L$). A Gordon surface [24] can be estimated to overcome the curve-surface fitting problem that has an infinite number of solutions. This particular solution is based on the sum of three surfaces $\mathbf{S}(u, v) = \mathbf{S}_1(u, v) + \mathbf{S}_2(u, v) - \mathbf{T}(u, v)$, where $\mathbf{S}_1(u, v) = \sum_{l=0}^s \mathbf{C}_l(v) \alpha_l(u)$ and $\mathbf{S}_2(u, v) = \sum_{k=0}^r \mathbf{C}_k(u) \beta_k(v)$ contains all $\mathbf{C}_l(v)$ and $\mathbf{C}_k(u)$. The blending functions $\{\alpha_l(u)\}_{l=0}^s$ and $\{\beta_k(v)\}_{k=0}^r$ satisfy the constraints:

$$\alpha_l(u_i) = \begin{cases} 0 & \text{if } l \neq i \\ 1 & \text{if } l = i \end{cases} \quad (4)$$

$$\beta_k(v_i) = \begin{cases} 0 & \text{if } k \neq i \\ 1 & \text{if } k = i \end{cases}$$

$\mathbf{S}_1(u, v)$ and $\mathbf{S}_2(u, v)$ have remarkable properties because they are skinned functions. Skinning can be defined as the procedure to create a surface given a set of curves $\{\mathbf{C}_k(u)\}$ in the u direction with respect to a blending direction v . The third function can be estimated as $\mathbf{T}(u, v) = \sum_{l=0}^s \sum_{k=0}^r \mathbf{Q}_{l,k} \alpha_l(u) \beta_k(v)$ and contains the intersection points between the curves.

An alternative solution to the surface fitting problem is needed when the curve network does not satisfy the previous requirements (e.g. any of the curves in one direction of the network do not intersect all of the other curves). The proposed solution uses surface deformation techniques [26,10] to generate progressive modifications of a seed surface according to a given curve network. In the proposed methodology, surface geometry is progressively adjusted to transform a planar seed surface into a new 3D surface that follows point cloud and curves. The seed surface is a plane with a predefined number of sub-divisions (usually more than 400). Local modifications in the seed surface can be performed by modifying weights, control points, and knot vectors. The procedure is carried out by considering multiple modifications not limited to a single parameter. For instance, the modification of a single control point leads to an unnatural final shape, whereas altering a set of control points provides a more realistic and smooth surface [35]. The method exploits the properties of NURBS for which a manipulation of a part of the surface provides modifications only in a confined area, without altering the whole surface.

The advantages of this second strategy rely on a more automated procedure that takes into consideration generic curve networks. Few manual profiles are needed to run this second methodology, which however is less stable than the previous method based on Gordon surfaces. As mentioned, the number of internal subdivision of the seed plane must be set beforehand. The orientation in space of the subdivisions is another essential parameter, otherwise the internal subdivision of surfaces will not follow the dominant direction of real objects. Boundaries (also called edges) are also extremely important because they delineate the appearance of a freeform shape. They are used to fit the surface and to join multiple surfaces.

Shown in Fig. 2c is the final NURBS surface for the umbrella vault, that is made up of NURBS surfaces of 3rd degree with a variable number of internal subdivisions (23×23 or 33×33). Manual boundaries (the interactive measurements used to define the curve network) are used to trim the surfaces obtaining a regular surface without interruptions.

2.2. From NURBS surfaces to as-built parametric objects

The set of NURBS surfaces is a reconstruction of the external surface of the objects surveyed with point clouds, whereas BIM objects are solids with parametric geometry. One of the main issues in as-built BIM generation is the choice of the parameters which need parametrization, as well as the kind of parametrization required. The aim of this paragraph is to demonstrate that a complex NURBS surface can be the starting point for a parametrization that provides an editable solid.

In the case of the vault shown in Fig. 2, parametric modeling is used to create a customizable solution for parts that cannot be reached by standard surveying techniques. As the laser scanning point cloud of the vault captured only the intrados (the inner surface of the vault in Fig. 2), there is no geometric information about the thickness (T) of the vault (only the ceiling is visible from upstairs, therefore the extrados cannot be surveyed). T becomes a dynamic parameter and an initial assumption can be used to provide a preliminary reconstruction. Obviously, this initial choice requires some information about the logic of construction. In this case, after a review of the different data sources (mainly existing reports), the initial thickness T was set to 200 mm, which can be automatically modified without redrawing by using parametric modeling. This is a remarkable benefit of parametric modeling: initial assumptions can be edited by simple modifications of the numerical value stored in the project database. The geometric model is automatically modified to correctly represent the new configuration, which is based on the assumption that the extrados and the intermediate layers can be obtained by an offset of the intrados. Obviously, there is no guarantee that the thickness is constant and only a destructive inspection could reveal the real geometry. However, such hypothesis can be useful not only for the creation of a volumetric object, but also for other operations that require a solid representation, such as cost analysis and estimation of volumes. The generation of a multi-layer structure with multiple offsets is also mandatory to take into consideration the different materials of the vaults.

Given a NURBS surface $\mathbf{S}(u, v)$, the offset surface is $\mathbf{S}'(u, v) = \mathbf{S}(u, v) + T\mathbf{N}(u, v)$, where T is the offset distance and \mathbf{N} the normal vector. $\mathbf{S}'(u, v)$ is not only a translated copy of the original surface, but a different NURBS surface. A precise solution to the offset problem can be found only for a limited number of standard surfaces (e.g. cylinders and spheres), whereas generic NURBS representations require numerical approximations. In addition, the offset surface is usually made up of a larger number of control points and knots, which can be simplified to reach a predefined tolerance [37]. The computation of $\mathbf{S}'(u, v)$ can be carried out by surface sampling based on the second derivative, then the offset surface is simplified via knot removal. The sub-vertical edges of offset and original surfaces are then connected with other NURBS surfaces to obtain a volumetric representation.

Fig. 3 shows the result for the umbrella vault. As mentioned, BIM objects require a volumetric representation where the reconstruction must be completed by additional NURBS surfaces that interpolate the volume between intrados and extrados. The thickness T was the unique parametrized value used to generate different volumetric representations of the vault. The different

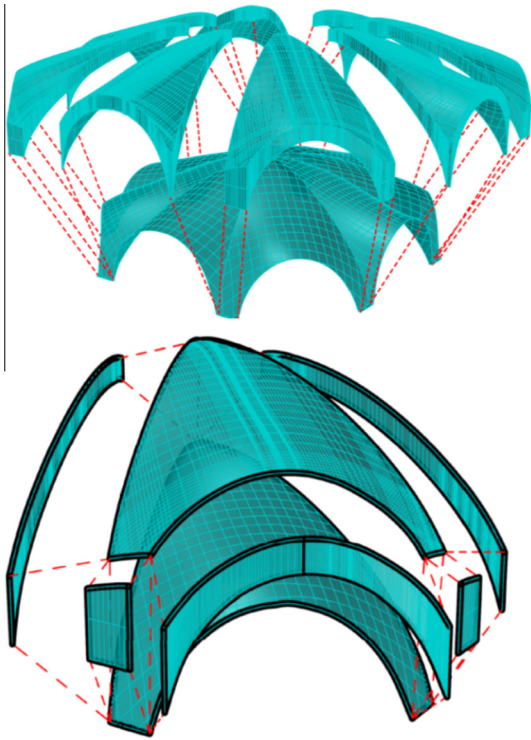

Fig. 3. The creation of a parametric object requires a volumetric representation that takes into account layers and surfaces that are not revealed by point clouds. The thickness becomes a dynamic parameter that allows one to modify the vault without redrawing.

parts of the vault surveyed with point clouds (e.g. the intrados) were instead considered static shapes.

Parametric modeling can be used for several purposes. The reconstruction of the vault shown in Figs. 2 and 3 demonstrate that parametric modeling can be used to create a customizable solution for parts that cannot be reached with standard surveying techniques. This aspect introduces a relevant problem about the choice of elements that require parametrization as well as the kind of parametrization required.

In the case of as-designed BIM projects, the parametrization problem concerns the size of the model (memory occupation) and the position and attitude of the object in space. For example, a door requires some positional parameters such as level (ground floor, basement, etc.), still height, and distances from the vertical edges of the walls. Geometric parameters are instead thicknesses, height, width, trim projection (exterior and interior), and trim width. In the case of the vault of Fig. 3, position and shape of the intrados are provided by laser scanning point clouds. After measuring the intrados of the vaults and representing the shape with NURBS surfaces, it was decided to create a parametric representation of the thickness. This is motivated not only by the complexity of the parametrization of the intrados, but also by the requirements of the project related to the preservation of the physical integrity of objects of historical value.

As-built parametric modeling has positional constraints that depend on metric data (point clouds in this case). However, the parametrization problem is quite generic (without guidelines or standards) and depends on two aspects:

1. the possibility to parametrize complex surfaces captured by point clouds (technology driven);
2. human interpretation and personal choices during the creation of the as-built model.

Different operators can make different decisions about the objects which need a parametric representation. This aspect is a relevant problem not only for as-built projects, but also in as-designed projects with predefined object libraries combined to complex shapes. Some examples are illustrated in Fig. 4, where complex surfaces generated with the proposed NURBS-based methodology were employed to obtain advanced “roof”, “wall” and “curtain wall” objects. The shape of these irregular objects is not available in existing libraries and the creation of an “initial surface” turned into a parametric object is mandatory.

Although commercial BIM packages have native tools for NURBS modeling, only simple algorithms are available, mainly based for operations such as extrusion, blend, sweep, and revolve of splines. The use of these packages is not user-friendly and most designers prefer to work with other pure (direct) modeling environments such as Maya, 3D Studio Max, and Rhinoceros, which are more flexible but do not provide parametric objects.

The proposed solution for a parametric representation of the surveyed surfaces can be used for advanced as-designed BIM, as illustrated in Fig. 4. The surface of the roof (Fig. 4 – top) was generated through a loft starting from a set of NURBS curves, obtaining the base surface for the bottom part of the roof. An automatic offset was used to generate the top face, exploiting the advantages of parametric modeling. The object is correctly recognized as “roof” by Autodesk Revit, meaning that the relationships between the new roof and other elements can be used in an efficient and organized BIM project. Examples of BIM functionalities are the automatic connection between “roof” and “wall” and the “opening cut” for a chimney, both correctly recognized as advanced operations in the final BIM environment.

The basic surface of the wall in Fig. 4 (middle) is instead made up of a single NURBS surface of degree 2. Elements are not vertical because the NURBS curves (top and bottom) are different. In all, 30 (horizontal) \times 18 (vertical) divisions were used to obtain the wall. The surface was turned into a generic “wall” object with a parametrization of the thickness, assuming the NURBS surface as the external part of the model. The new “wall” object is consistent with other predefined objects such as “windows” and “doors”, that can be automatically placed inside the wall with a cut performed by the BIM software.

The last case (Fig. 4 – bottom) is instead a surface derived from planar NURBS curves placed at different heights. The surface was turned into a “curtain system” with glazed panels. An additional grid of 800 mm \times 1000 mm was added to accommodate a rectangular “mullion”. This operation is carried out in a fully automated way after setting the grid size as “the maximum space”.

As can be seen, all objects have a particular parametric representation as well as semantic relationships with other objects [14]. Objects must have proper semantic components (beyond geometry) to provide an efficient and consistent project workflow, where geometry and relationships are therefore correlated by topological algebra. However, the case of complex shapes can provide additional issues. As mentioned in the previous sections, thickness parametrization can be obtained by an offset of the surface, which is not a simple translation along prefixed directions. Shown in Fig. 5 (top) is a detail of the roof illustrated in Fig. 4. The roof was modeled with an offset profile (orange). The offset is applied along the orthogonal direction to the surface in order to ensure a constant thickness. Then, the figure shows some additional offsets of the same distance. It is clear that the offset surface is not only a translated copy: it is a new function that can have geometric discontinuities.

Additional issues arise when the analysis is carried out by considering the whole surface and not only a line. As the original surface is generated from a set of irregular curves, offset curves are not

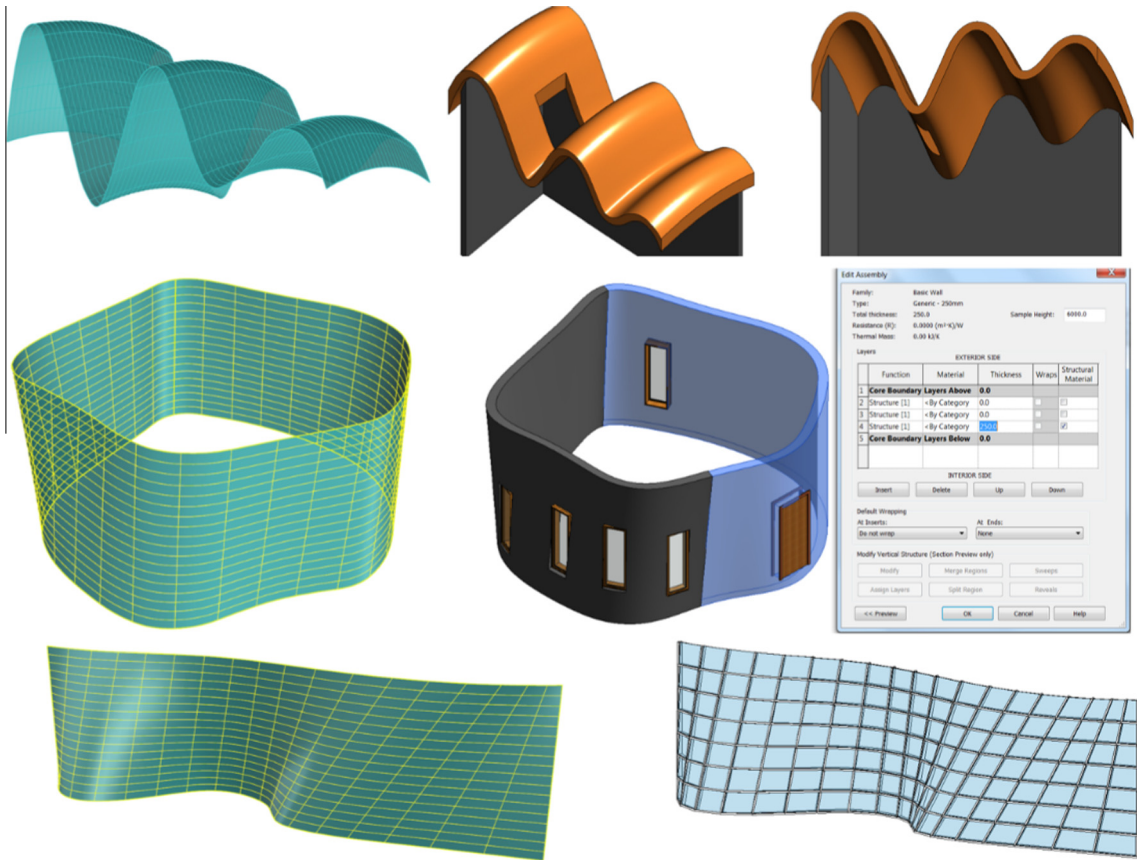

Fig. 4. Different irregular objects designed with the proposed procedure based on NURBS. The proposed offset method can be useful not only for existing objects, but also for the parametrization of complex as-designed shapes.

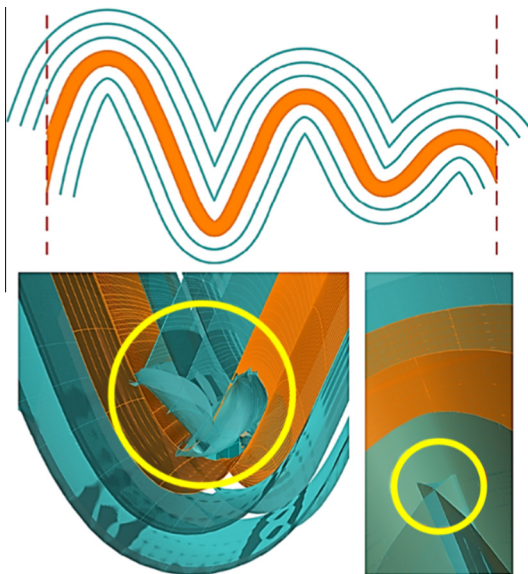

Fig. 5. The offset of NURBS surfaces can lead to geometric inconsistencies that are not compatible with BIM logic.

constant. The problem is intended as the offset of the whole NURBS surface, which can lead to the geometric inconsistency shown in Fig. 5 (bottom). Self-intersections and other geometric issues are not only a visual problem that can be hidden with the closure of external surfaces. They are not compatible with basic parametric modeling requirements and can be revealed by BIM packages with

procedures for clash detection (also called conflict checking). In the case of complex shapes, the aspect of self-intersection is still not completely solved in the proposed methodology. It requires future work to obtain consistent parametric representations for very complex shapes.

3. Testing in real as-built parametric modeling projects

The case studies illustrated and discussed in the paper are real applications where an accurate as-built parametric model was generated from point clouds. The case studies demonstrate that the proposed approach can provide accurate and detailed parametric reconstructions for specific constructive elements of irregular buildings. However, a particular attention is needed to understand the kind of parametrization required.

3.1. Case study 1: as-built parametric modeling in the case of geometric anomalies

Parametric modeling is not limited to buildings. It can be used for a large variety of civil infrastructures such as dams, bridges, tunnels or highways. Shown in Fig. 6 is the smokestack at Politecnico di Milano (Milan, Italy), which was surveyed with laser scanning technology. Eight scans were acquired with a Faro Focus 3D and were registered in a reference system given by total station measurements (the instrument used is a Leica TS30). The aim of the project was the generation of an accurate as-built model that takes into consideration the real shape of the structure. In particular, one of the goals was the inspection of verticality deflections and their accurate geometric representation.

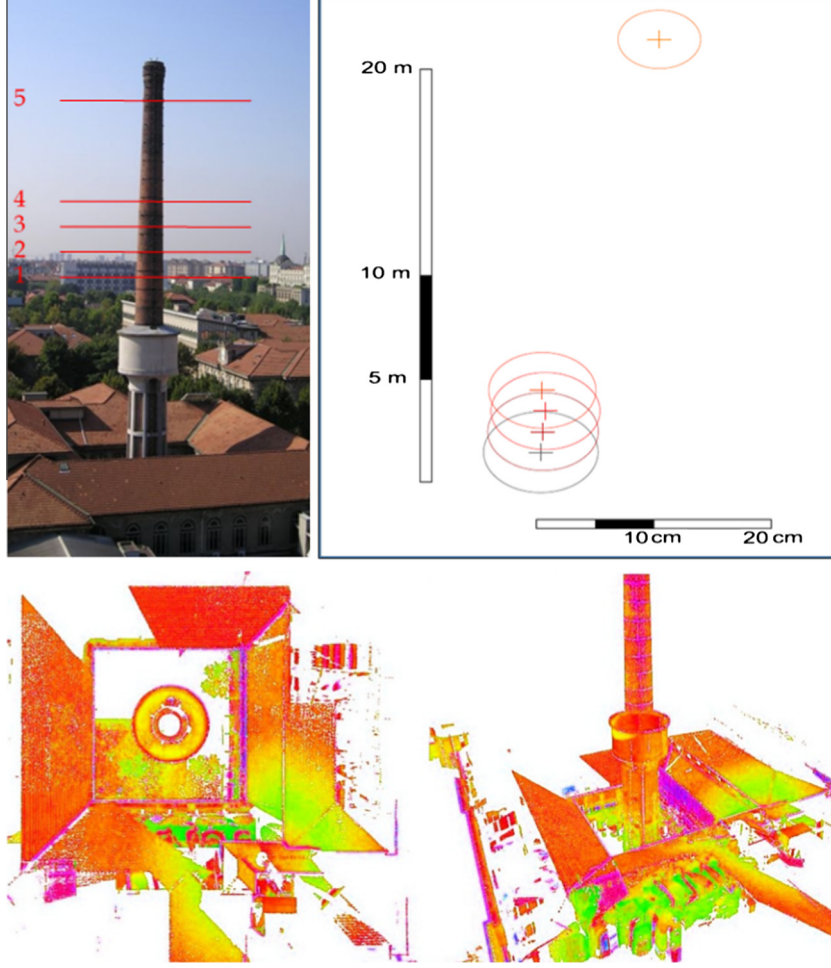

Fig. 6. Top: The smokestack and some horizontal sections that highlight a significant deflection along the vertical direction. Bottom: a visualization of the registered point clouds.

Because the survey captured the external surface of the smokestack, one of the elements that required parametrization was the thickness of external walls along with the thickness of the piezometric water tower. The extraction of a NURBS curve network was carried with a set of horizontal and vertical cutting planes. The analysis of the horizontal sections provided information about the shape, which seemed circular above the reinforced concrete water tank.

As mentioned, NURBS curves can reconstruct free-form shapes as well as basic forms commonly used in technical drawings. The particular case of circles is considered here. Although the implicit equation $f(x, y) = 0$ of a generic curve is unique up to a multiplicative constant, its parametric representation can be written in different ways. As the case study refers to circles, let us consider the circle of unary radius centered at the origin, whose equation is $f(x, y) = x^2 + y^2 - 1 = 0$. Two distinct parametric forms can be written as:

$$\begin{cases} x(u) = \cos(u) \\ y(u) = \sin(u) \end{cases} \quad u \in [0, \pi/2] \quad (5)$$

$$\begin{cases} x(t) = \frac{1-t^2}{1+t^2} \\ y(t) = \frac{2t}{1+t^2} \end{cases} \quad t \in [0, 1] \quad (6)$$

Different NURBS representations of a full circle can be obtained by varying control points, weights, degree and knot vector. For instance, the same circle can be reconstructed from the same

number of points (7 in this case) with different control point coordinates, weights, and knot vectors:

$$\{\mathbf{P}_i\} = \left\{ (0, -1), (-\sqrt{3}, -1), \left(\frac{-\sqrt{3}}{2}, \frac{1}{2} \right), (0, 2), \left(\frac{\sqrt{3}}{2}, \frac{1}{2} \right), (\sqrt{3}, -1), (0, -1) \right\}$$

$$\{w_i\} = \left\{ 1, \frac{1}{2}, 1, \frac{1}{2}, 1, \frac{1}{2}, 1 \right\}$$

$$U = \left\{ 0, 0, 0, \frac{1}{3}, \frac{1}{3}, \frac{2}{3}, \frac{2}{3}, 1, 1, 1 \right\}$$

and

$$\{\mathbf{P}_i\} = \left\{ \left(0, -\frac{1}{2} \right), \left(-\frac{1}{2}, -\frac{1}{2} \right), \left(-\frac{1}{2}, \frac{1}{2} \right), \left(0, \frac{1}{2} \right), \left(\frac{1}{2}, \frac{1}{2} \right), \left(\frac{1}{2}, -\frac{1}{2} \right), \left(0, -\frac{1}{2} \right) \right\}$$

$$\{w_i\} = \left\{ 1, \frac{1}{2}, \frac{1}{2}, 1, \frac{1}{2}, \frac{1}{2}, 1 \right\}$$

$$U = \left\{ 0, 0, 0, \frac{1}{4}, \frac{1}{2}, \frac{1}{2}, \frac{3}{4}, 1, 1, 1 \right\}$$

An alternative representation can be obtained from 9 points:

$$\{\mathbf{P}_i\} = \left\{ \left(0, -\frac{1}{2}\right), \left(-\frac{1}{2}, -\frac{1}{2}\right), \left(-\frac{1}{2}, 0\right), \left(-\frac{1}{2}, \frac{1}{2}\right), \left(0, \frac{1}{2}\right), \right. \\ \left. \left(\frac{1}{2}, \frac{1}{2}\right), \left(\frac{1}{2}, 0\right), \left(\frac{1}{2}, -\frac{1}{2}\right), \left(0, -\frac{1}{2}\right) \right\}$$

$$\{w_i\} = \left\{ 1, \frac{1}{\sqrt{2}}, 1, \frac{1}{\sqrt{2}}, 1, \frac{1}{\sqrt{2}}, 1, \frac{1}{\sqrt{2}}, 1 \right\}$$

$$U = \left\{ 0, 0, 0, \frac{1}{4}, \frac{1}{4}, \frac{1}{2}, \frac{1}{2}, \frac{3}{4}, \frac{3}{4}, 1, 1, 1 \right\}$$

This means that different ways to represent the same circle can be used. Graphical results for the previous circles are shown in Fig. 7. One may ask why a generic NURBS curve is not directly used for horizontal sections. The answer depends on several issues: constructions are gradually assembled following particular geometries and criteria. If the section is a circle, additional information is useful to plan further activities, i.e. geometric deviations from the initial hypothesis can be highlighted by point clouds and communicated to the different experts involved in the project. In addition, if sections can be described by circles, geometric operations for thickness parametrization can be rigorously carried without approximations (circles can be offset precisely).

A set of equally spaced horizontal sections was extracted for the part above the water tower. After least squares circle fitting the

statistics for the different sections were analyzed. The precision $\sigma_a, \sigma_b, \sigma_r$ of center coordinates (a, b) and radius r were computed for the fitted circles, obtaining good geometric correspondence for the lowest levels (section 1, 2, 3, 4 with precision better than ± 2 mm). A progressive worsening of fitting results was found on top of the smokestack (section 5 with precision of about ± 4 mm). This confirms the initial hypothesis about the circular sections of the structure. A progressive deviation from verticality was discovered for the computed center coordinates (a, b) at different levels. The horizontal deviation is larger than 100 mm on the top of the structure. This is a very important aspect that must be taken into consideration in the final model.

The creation of the as-built model was carried out by using generic NURBS of 2nd degree for the circular shaft, adding vertical sections that follow the longitudinal direction of the structure. The pillars of the water tower were modeled with NURBS of 1st degree, whereas horizontal circles and (vertical) NURBS curves were used for the water tank. Metal stairs were simply included as static shapes without parametrization (direct modeling). A visualization of the final model and some details are shown in Fig. 8.

3.2. Case study 2: preservation of accuracy in as-built models from point clouds

As-designed models can be delivered with a scale factor 1:1 to satisfy the requirements of typical projects with variable metric scales and levels of detail. The scale factor (m) achievable from a

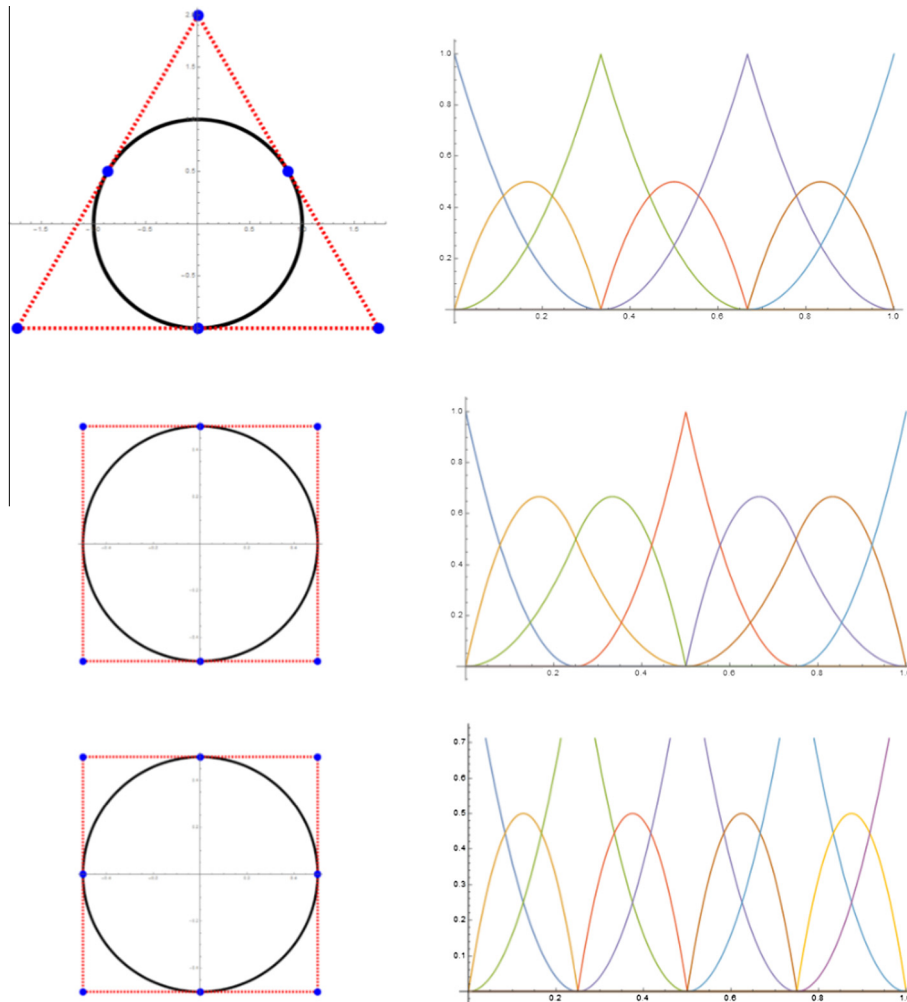

Fig. 7. Different representations for the circles used to model the smokestack.

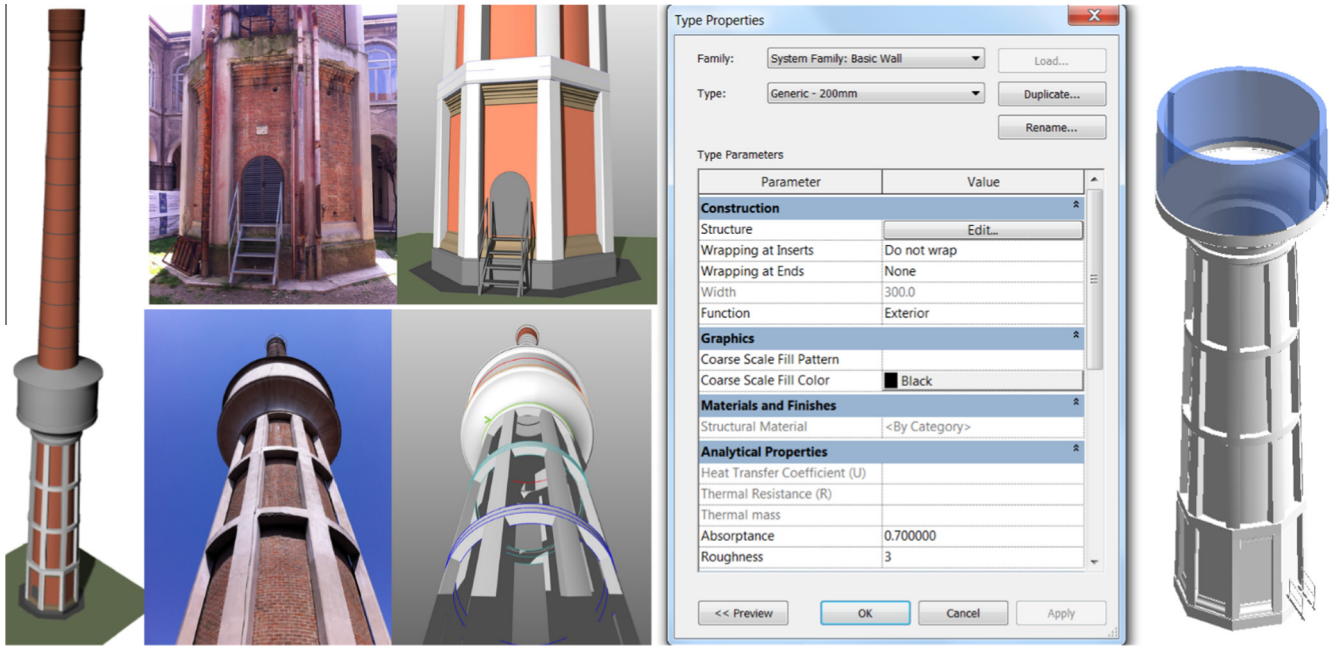

Fig. 8. The final as-built model of the smokestack with the parametrization of different objects.

survey depends on the size of the object, the instruments for data acquisition and the procedures used to turn raw data into usable products. Given a separation threshold $e = 0.2$ mm in printed project boards (usually used in cartographic and mapping applications), the corresponding metric value in terms of world coordinates is given by $E = e \cdot m$. A laser scanner with a precision of ± 2 mm can be used to obtain a representation with scale factor 1:10 (i.e., $E = 2$ mm), that is more than sufficient for common project scales 1:20, 1:50, and 1:100. On the other, this is not sufficient to reach the scale 1:1 of as-designed objects (i.e., $E = 0.2$ mm).

As demonstrated in the previous section, existing constructions have deviations (vertical deflection, variable thickness, etc.) from the basic assumptions made in the design phase. These deviations should be taken into consideration during the creation of the as-built model (according to the needed level of detail and metric scale). The previous statement plays a fundamental role in a cost-effective approach for productive work. The creation of the as-built model comes at a cost and a correct estimation of time and cost needed to complete the survey is crucial [40].

The proposed methodology for parametric modeling can be assumed as a scalable procedure where parameters are interactively handled to preserve the metric information encapsulated into laser clouds. This aspect should be taken into account to reduce the size of the final model, avoiding useless details and enhancing productivity. For instance, coarse reconstruction scales (1:100–1:200) do not require fine details, which can result in time and cost issues as well as heavy models in terms of memory occupation (data storage).

Given a set of registered point clouds, a variable level of detail of the NURBS-based reconstruction approach can be exploited following an automated strategy which ends when the expected metric accuracy has been reached. Shown in Figs. 9 and 10 are the results for the mosaic of the chapel of San Vittore in Ciel d'oro in the Basilica of Sant'Ambrogio (Milan, Italy). The short distance (less than 4 m) between the laser scanner and the dome (during scan acquisition) provided a point cloud with an expected accuracy of ± 2 –3 mm.

Modeling was initially carried out by fitting a sphere through the measured laser scanning points. As NURBS surfaces can model

both natural and general quadrics, it is simple to use a sphere for the first approximation. Geometric parameters were estimated via least squares. Then, the sphere was compared to the raw point cloud with the commercial package Geomagic Studio. The estimated standard deviation of the overall discrepancy was ± 25 mm, much larger than laser precision, but still sufficient for coarse project scales (i.e. 1:100 or 1:200).

Data processing was then repeated with a progressive densification of NURBS curves, which form a consistent network in space (Fig. 10). A multi-resolution approach was used for the network with 3, 10, 20, and 33 internal subdivisions. An increment of the subdivision provided a more flexible solution, leading to a progressive improvement of geometric accuracy. As the whole procedure is fully automated and provide real-time results, the user can set a small initial number of divisions and check the quality of results in terms of discrepancy with the point cloud. The procedure can be iterated by increasing the number of subdivisions until the expected accuracy is reached. In this case, the expected accuracy of raw data was found with 33×33 subdivisions, for which the global discrepancy of 2.1 mm was similar to the precision of the laser scanner.

The surface was then converted into a parametric object with the automated offset of the thickness. Results are shown in Fig. 10, where additional images can be projected on the final NURBS surface by using texture mapping algorithm. The thickness has an internal layer-based structure that can be handled by expert operators interested in conservation.

4. Parametric modeling of historic buildings

The creation of as-built models of historic buildings can be a real challenge for the complex shape of architectural elements. Such buildings are often characterized by geometric anomalies including walls with variable thickness, tilted columns, voids and floor deflections [29,34]. Existing libraries cannot be used for very detailed reconstructions because of the particular shape of historic constructions. The creation of a new library for each specific case study can be an alternative. However, it requires time-consuming manual measurements.

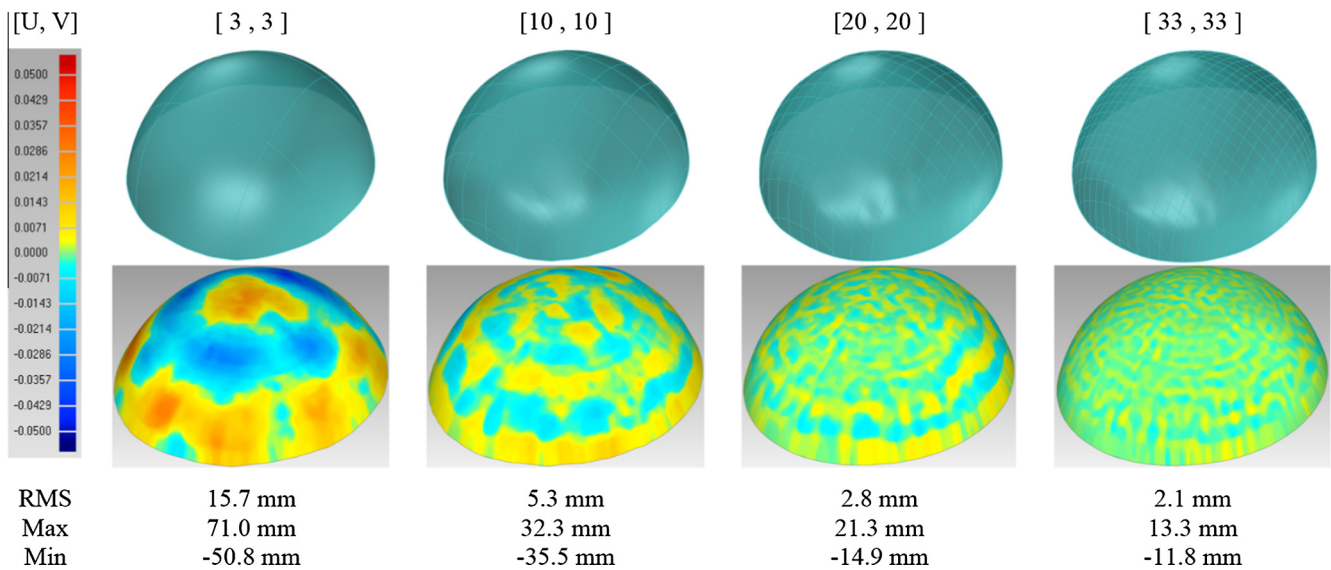

Fig. 9. The discrepancy between the NURBS surface and the point cloud can be reduced with an increment of internal subdivisions.

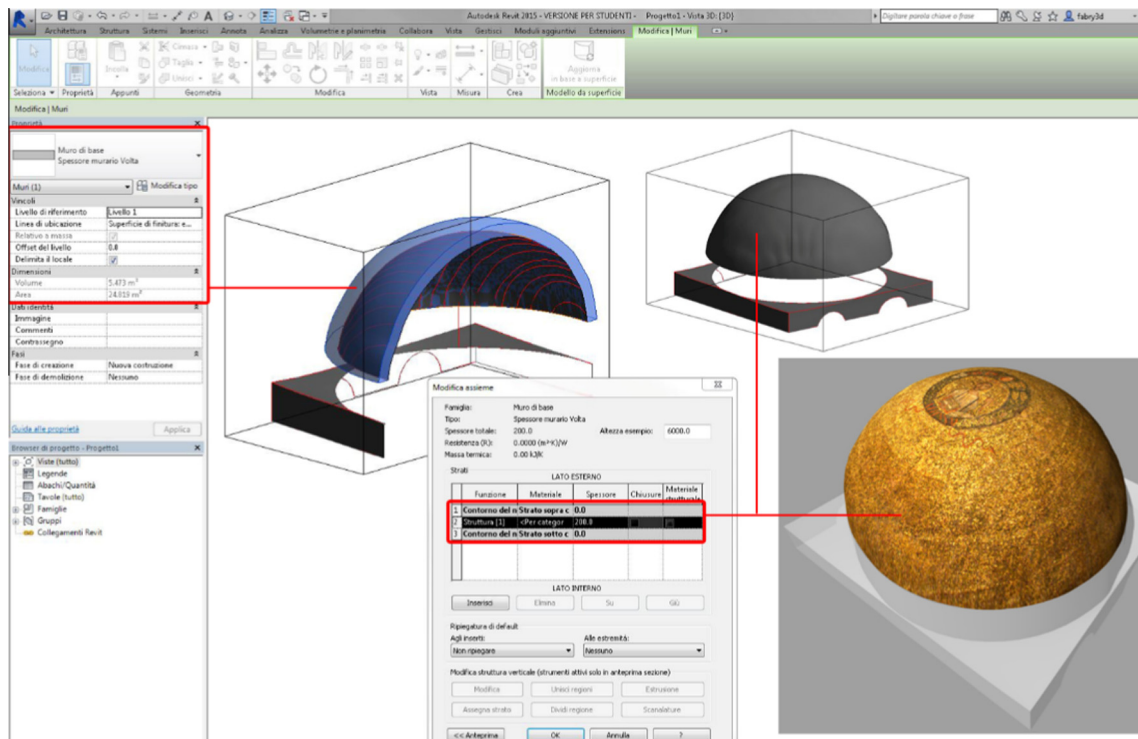

Fig. 10. The parametrization of the vault is consistent with parametric modeling requirements. Although the offset surface of the intrados could be only an approximation of the actual extrados surface (that cannot be surveyed by laser scanning techniques), volumetric analysis can be performed in a fully automated way.

The general procedure for the generation of a parametric model of such complex structures follows the scheme shown in Fig. 11. In the case of big structures, the data acquisition phase includes the survey of a geodetic network, that provides a stable reference system in which images and laser scans can be registered. This means that a set of ground control points measured with a total station are used for both photogrammetry and laser scanning technology. Images are oriented via bundle adjustment, then dense point clouds can be generated via dense matching algorithms. Laser scans are instead registered with a mathematical model based on a 6-parameter transformation.

Additional information is always needed in the case of historic buildings. Because they are the result of progressive transformations, existing drawings, reports, and a historic research cannot be neglected to understand and clarify the complexity of the building.

The generation of the parametric model can be carried out from a combined analysis of the collected data. Simple and regular objects can be directly modeled with commercial BIM packages available on the commercial market (Autodesk Revit in the proposed case study), whereas complex shapes can be reconstructed with the proposed procedure. Finally, complex objects are

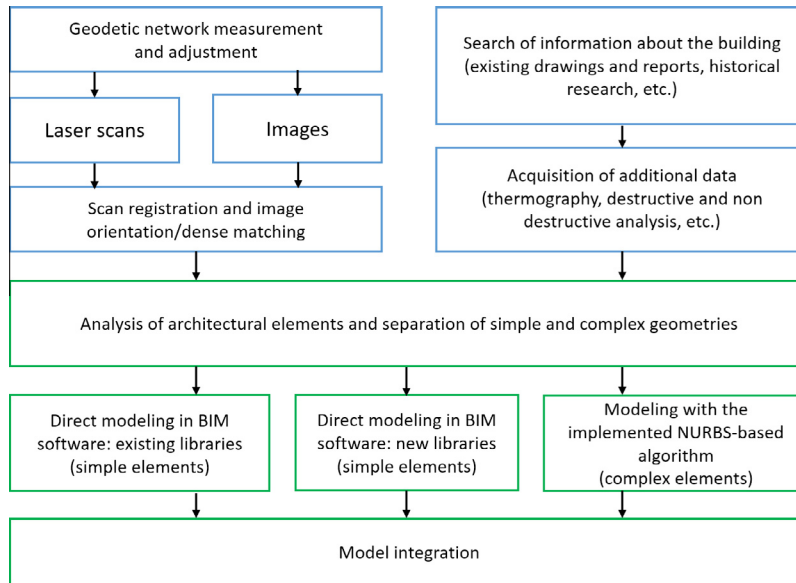

Fig. 11. The general scheme for the reconstruction of historic buildings.

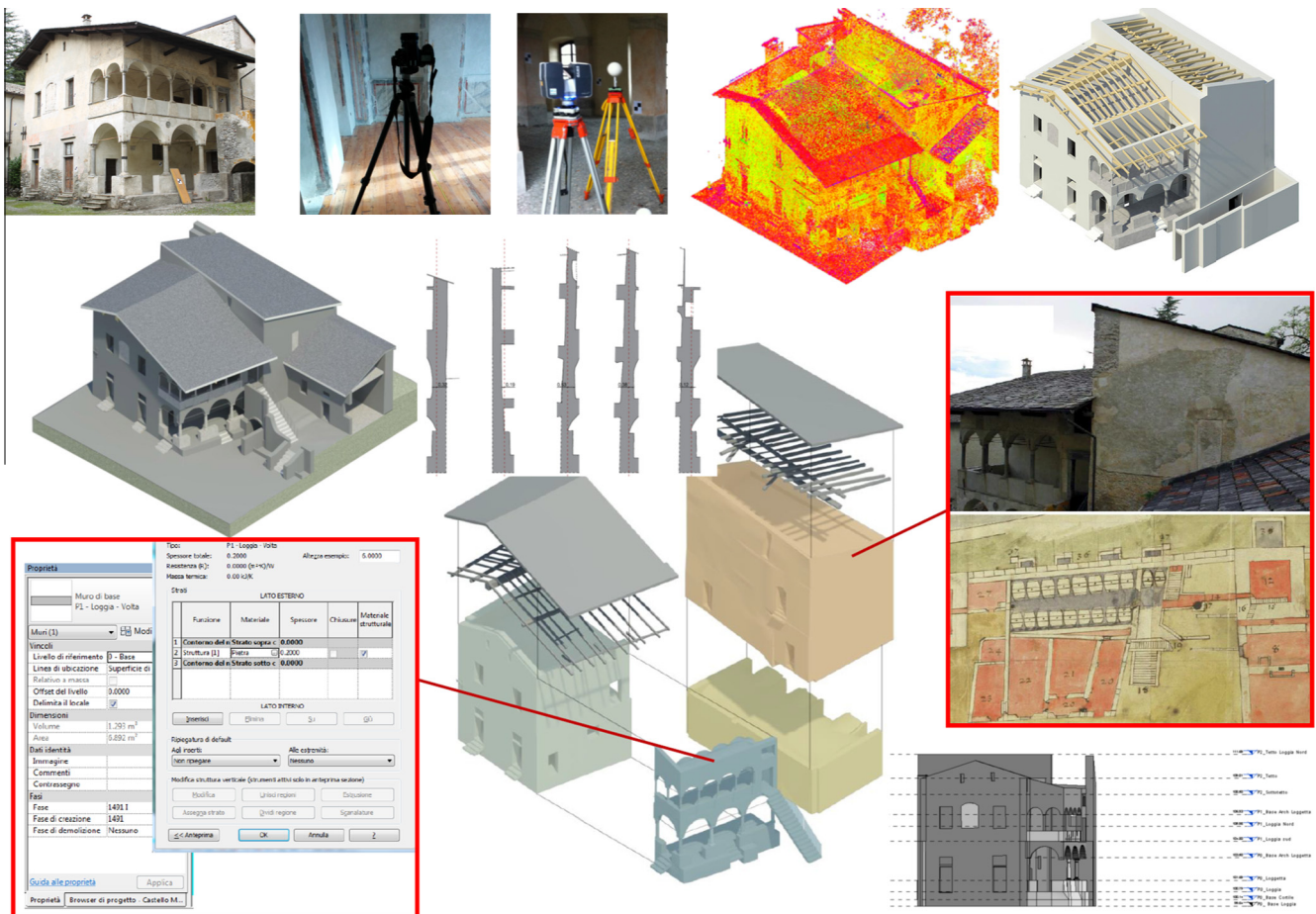

Fig. 12. The loggia of Castel Masegra (Sondrio, Italy) turned into an as-built parametric model.

imported in a common processing environment to allow the different specialists involved in the project to exploit the final parametric model.

An example of historic building (surveyed with laser scanning techniques and photogrammetry) is shown in Fig. 12. The building is the “loggia” of Castel Masegra (Sondrio, Italy) where a geodetic

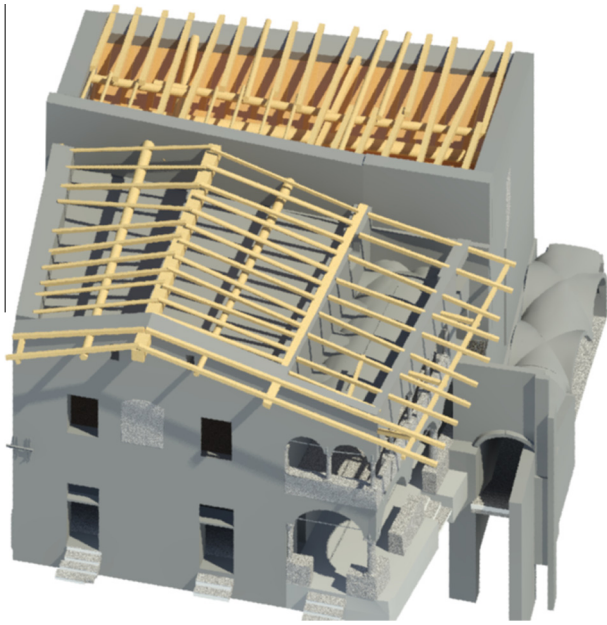

Fig. 13. Some objects that were modeled with existing libraries are beams and trusses.

network was used for scan registration, obtaining a precision better than ± 3 mm. The as-built parametric model of the building was generated from laser scanning point clouds integrated with an accurate visual inspection of constructive elements and their materials, as well as infrared thermography, information from destructive testing (coring, flat jack tests), historical research, and existing drawings. Multiple data sources were fundamental to obtain an exhaustive description of the building, revealing some interesting aspects which were correctly included in the final model.

For instance, some vertical and horizontal profiles extracted from the laser cloud revealed a lack of correspondence between the external walls of basement and ground floor. This is also confirmed by the historical research, from which it was evident that basement and ground floor belong to different construction stages. Another interesting aspect is the variable thickness of external walls (North wall ≈ 1 m, South wall ≈ 0.60 – 0.70 m, East wall ≈ 0.60 – 0.65 m, West wall ≈ 0.60 – 0.70 m, internal walls = 0.90 – 0.95 m), which corresponds to the modifications

occurred in the past (construction and demolition). External walls are not orthogonal and have a residual rotation of about 9° for the South facade, 3° for the East facade, and 2° for the West facade. The inspection of vertical laser sections revealed a variable thickness for the different floors and some deviations from the vertical direction.

One of the aims of the project was the creation of an interoperable model that can be managed by commercial software. Autodesk Revit was chosen as final processing environment and was sufficient for the reconstruction of simple and regular elements that can be correctly represented by predefined libraries, or a set of new libraries generated in Revit. Data processing with NURBS curves and surfaces was mandatory for complex elements like vaults and arches, which were directly modeled with a parametrization of NURBS surfaces. A preliminary attempt with the basic functions of Revit was carried out to model complex objects with geometric anomalies. On the other hand, Revit was not sufficient for the representation of the geometric anomalies previously described, which required NURBS curves and surfaces turned into parametric objects.

Examples of objects directly modeled with existing Revit libraries are beams and trusses. In this case, the required level of detail (scale 1:50) and the analysis of the shape with the point cloud revealed that standard libraries were sufficient (Fig. 13). Other elements directly reconstructed in Revit were floors and ceilings, which seemed quite regular after the inspection of laser scans.

The reconstruction of the columns was instead impossible with the sets of existing libraries. A new ad-hoc library was created by using NURBS curves to produce surfaces with a complete geometric parametrization. Their modeling was directly carried out in the family editor of the software and processing algorithms such as revolution and extrusion. The new object “column” is subdivided into 4 parametric objects with an edge-to-edge constraint and a complete three-dimensional parametric representation of different parts. An additional constraint based on “middle points” was included to provide a symmetric reconstruction (Fig. 14).

The reconstruction of the roof needed a combined approach. As mentioned, some parts were modeled with standard Revit families (e.g. beams and trusses), whereas the shape of roof external layer is very irregular and was modeled with the strategy based on NURBS curves and surfaces (Fig. 15). The six complex vaults were modeled only with the proposed NURBS-based solution. Indeed, 3D modeling tools available in Revit (including existing libraries and new families generated with the editor tool) were not sufficient for an

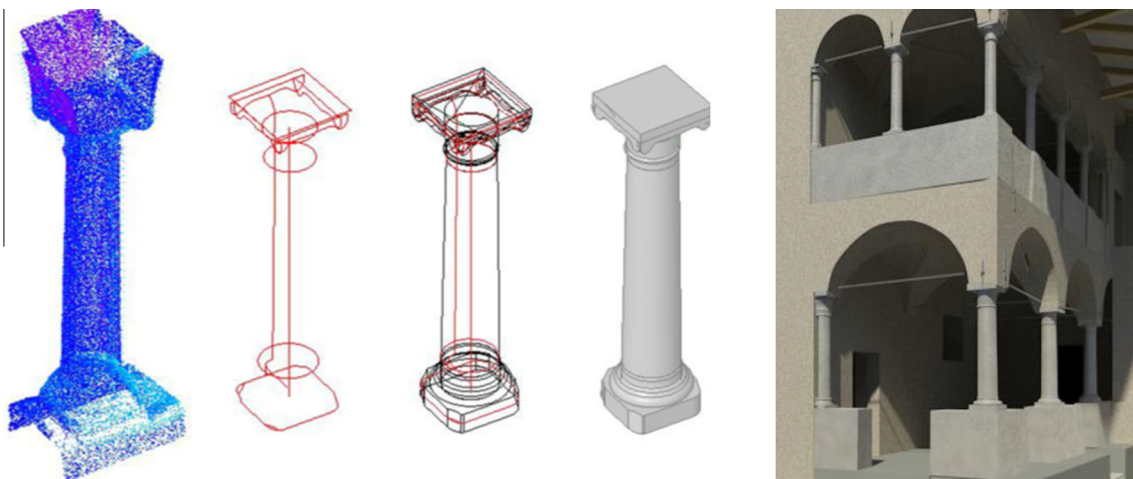

Fig. 14. Columns were parametrized with the native Revit tools in the family editor.

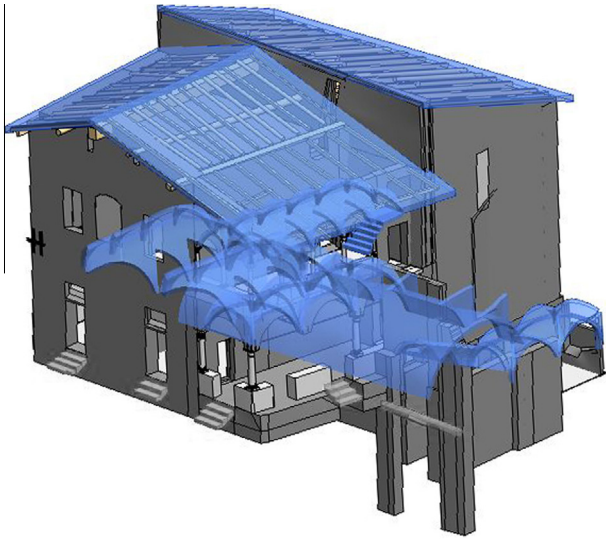

Fig. 15. The proposed methodology was used for complex shapes such as roof and vaults (highlighted in blue in the picture). (For interpretation of the references to color in this figure legend, the reader is referred to the web version of this article.)

accurate geometric representation of the irregular vaults. For this reason, the vaults with lunettes were modeled with the extraction of their breaklines from the point cloud. Then, curves were used as external constraint to drive the generation of NURBS surfaces. The same procedure was repeated for the barrel vault, that is quite irregular and required NURBS surfaces fitted with the proposed methodology (Fig. 15). Finally, the parametrization was included by generating a multi-layer offset surface for the reconstruction of the extrados, obtaining a complete solid objects.

The final as-built parametric model is made up of the following elements: 248 walls, 15 columns, 13 floors, 1 ceiling, 2 railings, 6 roofs, 8 stairs, 128 structural framings, and 2 “topographic” objects for the ground. Different parametrization levels were used for different objects, including a partial or full parametrization depending on specific functional requirements.

5. Conclusions

This paper presented a methodology for the generation of as-built parametric models from dense point clouds able to reveal the actual shape of existing constructions. Starting from a set of registered point clouds, NURBS curves that form a rigid curve network were extracted in a semi-automated way by considering the logic of construction of the building. Then, NURBS surfaces driven by both network and point cloud were generated to reconstruct the shape of complex objects along with their geometric anomalies. As NURBS are mathematical functions defined by numerical coefficients, a rigorous mathematical parametrization becomes feasible and allows the creation of parametric objects. The kind of parametrization shown in this work is optimal for constructive elements that require thickness parametrization with multiple layers.

The choice of NURBS curves and surfaces was motivated by the need to model complex and irregular geometries through numerically stable and fast processing algorithms. On the other hand, semi-automated measurements were mandatory for the lack of automated object-recognition algorithms able to recognize and separate the different constructive elements. Future research work will be carried out to improve the proposed methodology, especially the selection of parameters for surface fitting. Iterative algorithms that provides multiple solutions through the variation

of predefined parameters can be implemented to arrive at a final surface that approximates the point cloud with a sufficient metric accuracy. Models with a limited number of subdivisions can be progressively refined to reach a compromise between the level of detail and the size of the model in terms of number of elements (e.g. NURBS surface subdivision). The numerical evaluation of the achieved accuracy can be estimated with a comparison with the point cloud. Particular attention will also be paid to self-intersection issues during the automated parametrization of complex shapes. The offset of complex objects made up of several surfaces can generate local problems (e.g. intersections) not consistent with the basic requirement of parametric reconstructions.

References

- [1] Y. Arayici, Towards building information modelling for existing structures, *Struct. Surv.* 26 (2008) 210–222.
- [2] K. Bae, D.D. Lichti, A method for automated registration of unorganised point clouds, *ISPRS J. Photogramm. Rem. Sens.* 63 (1) (2008) 36–54.
- [3] A. Baik, A. Alitany, J. Boehm, S. Robson, Jeddah historical building information modelling “JHBIM” – object library, *ISPRS Ann. Photogramm. Rem. Sens. Spatial Inform. Sci.* II-5 (2014) 41–47.
- [4] L. Barazzetti, F. Banfi, R. Brumana, G. Gusmeroli, D. Oreni, M. Previtali, F. Roncoroni, G. Schiantarelli, BIM from laser clouds and finite element analysis: combining structural analysis and geometric complexity, *Int. Arch. Photogramm. Rem. Sens. Spatial Inform. Sci.* XL-5/W4 (2015) 345–350.
- [5] J.A. Beraldin, L. Cournoyer, M. Rioux, F. Blais, S. El-Hakim, G. Godin, Object model creation from multiple range images: acquisition, calibration, model building and verification, in: *Proceedings of the International Conference on Recent Advances in 3-D Digital Imaging and Modeling*, Ottawa, Ontario, 1997, pp. 326–333.
- [6] I. Brilakis, M. Lourakis, R. Sacks, S. Savarese, S. Christodoulou, J. Teizer, A. Makhmalbaf, Toward automated generation of parametric BIMs based on hybrid video and laser scanning data, *Adv. Eng. Inform.* 24 (4) (2010) 456–465.
- [7] S. Boeykens, M. Santana Quintero, H. Neuckermans, Improving architectural design analysis using 3D modelling and visualization techniques, in: A.A.M. Ioannides, A. Georgopoulos, L. Kalisperis (Eds.), *VSM 2008, Digital Heritage – Proceedings of the 14th International Conference on Virtual Systems and Multimedia*, (On CDROM), 2008.
- [8] F. Bosché, Plane-based registration of construction laser scans with 3D/4D building models, *Adv. Eng. Inform.* 26 (1) (2012) 90–102.
- [9] D. Bryde, M. Broquetas, J.M. Volm, The project benefits of building information modelling (BIM), *Int. J. Project Manage.* 31 (7) (2013) 971–980.
- [10] D. Brujic, M. Ristic, I. Ainsworth, Measurement-based modification of NURBS surfaces, *Comput. Aided Des.* 24 (2002) 173–183.
- [11] A. Budroni, J. Boehm, Automated 3D reconstruction of interiors from point clouds, *Int. J. Archit. Comput.* 8 (2010) 55–73.
- [12] C. Chevrier, N. Charbonneau, P. Grussenmeyer, J. Perrin, Parametric documenting of built heritage: 3D virtual reconstruction of architectural details, *Int. J. Archit. Comput.* 8 (2) (2010) 131–146.
- [13] S. Chiarini, S. Cremonesi, L. Fregonese, F. Fassi, L. Taffurelli, A multi-range approach for cultural heritage survey: a case study in Mantua Unesco site, *ISPRS Ann. Photogramm. Rem. Sens. Spatial Inform. Sci.* II-5 (2014) 157–164.
- [14] L. De Luca, C. Busayarat, C. Stefani, P. Véron, M. Florenzano, A semantic based platform for the digital analysis of architectural heritage, *Comput. Graph.* 35 (2) (2011) 227–241.
- [15] C. Dore, M. Murphy, S. McCarthy, F. Brechin, C. Casidy, E. Dirix, Structural simulations and conservation analysis-historic building information model (HBIM), *Int. Arch. Photogramm. Rem. Sens. Spatial Inform. Sci.* XL-5/W4 (2015) 351–357.
- [16] C. Eastman, P. Teicholz, R. Sacks, K. Liston, *BIM Handbook: A Guide to Building Information Modeling for Owners, Managers, Designers, Engineers and Contractors*, second ed., John Wiley & Sons Inc, 2011, p. 626.
- [17] S. El-Hakim, L. Gonzo, F. Voltolini, S. Girardi, A. Rizzi, F. Remondino, E. Whiting, Detailed 3D modelling of castles, *Int. J. Archit. Comput.* 5 (2) (2007) 199–220.
- [18] S. Fai, K. Graham, T. Duckworth, N. Wood, R. Attar, Building information modelling and heritage documentation, in: *18th International Conference on Virtual Systems and Multimedia. XXIII CIPA Symposium – Prague, Czech Republic – 12–16 September* (On CDROM), 2011.
- [19] S. Fai, J. Rafeiro, Establishing an appropriate level of detail (LoD) for a building information model (BIM) – West Block, Parliament Hill, Ottawa, Canada, *ISPRS Ann. Photogramm. Rem. Sens. Spatial Inform. Sci.* II-5 (2014) 123–130.
- [20] F. Fassi, C. Achille, L. Fregonese, Surveying and modelling the main spire of Milan Cathedral using multiple data sources, *Photogramm. Rec.* 26 (136) (2011) 462–487.
- [21] T. Gao, Akinci, S. Ergun, J. Garrett, An approach to combine progressively captured point clouds for BIM update, *Adv. Eng. Inform.* 29 (4) (2015) 1001–1012.
- [22] F. Habib, F. Dai, M. Lourakis, Automated as-built 3D reconstruction of civil infrastructure using computer vision: achievements, opportunities, and challenges, *Adv. Eng. Inform.* 29 (2) (2015) 149–161.

- [23] E.R. Fisk, *Construction Project Administration*, fifth ed., Prentice Hall, New Jersey, 1997.
- [24] W. Gordon, *Sculptured surface definition via blending function methods*, in: *Fundamental Developments of Computer Aided Geometric Modeling*, Academic Press, London, 1993, p. 414.
- [25] G. Guidi, B. Frischer, I. Lucenti, J. Donno, M. Russo, Virtualising ancient imperial Rome: from Gismondi's physical model to a new virtual reality application, *Int. J. Digit. Cult. Electron. Tourism* 1 (2–3) (2008) 240–252.
- [26] S.M. Hu, Y.F. Li, T. Ju, X. Zhu, Modifying the shape of NURBS surfaces with geometric constraint, *Comput. Aided Des.* 33 (2001) 903–912.
- [27] K. Khoshelham, L. Díaz-Vilariño, 3D modelling of interior spaces: learning the language of indoor architecture, *Int. Arch. Photogramm. Rem. Sens. Spatial Inform. Sci.* XL-5 (2014) 321–326 (ISPRS Technical Commission V Symposium).
- [28] M. Murphy, E. McGovern, S. Pavia, Historic building information modelling (HBIM), *Struct. Surv.* 27 (4) (2009) 311–327.
- [29] M. Murphy, E. McGovern, S. Pavia, Historic building information modelling – adding intelligence to laser and image based surveys of European classical architecture, *ISPRS J. Photogramm. Rem. Sens.* 76 (2013) 89–102.
- [30] C. Nagel, A. Stadler, T.H. Kolbe, Conceptual requirements for the automatic reconstruction of building information models from uninterpreted 3D models, in: T.H. Kolbe, H. Zhang, S. Zlatanova (Eds.), *GeoWeb 2009 Academic Track – Cityscapes*, vol. 38, ISPRS, Vancouver, BC, Canada, 2009, pp. 46–53.
- [31] J.J. O'Brien, *Construction Change Orders*, McGraw Hill, New York, 1998.
- [32] S. Oesau, F. Lafarge, P. Alliez, Indoor scene reconstruction using primitive driven space partitioning and graph-cut, in: *Eurographics Workshop on Urban Data Modelling and Visualisation*, Eurographics Association, 2013, pp. 9–12.
- [33] S. Oesau, F. Lafarge, P. Alliez, Indoor scene reconstruction using feature sensitive primitive extraction and graph-cut, *ISPRS J. Photogramm. Rem. Sens.* 98 (2014) 68–82.
- [34] D. Oreni, R. Brumana, S. Della Torre, F. Banfi, L. Barazzetti, M. Previtali, Survey turned into HBIM: the restoration and the work involved concerning the Basilica di Collemaggio after the earthquake (L'Aquila), *ISPRS Ann. Photogramm. Rem. Sens. Spatial Inform. Sci.* II-5 (2014) 6.
- [35] L. Piegl, Modifying the shape of rational B-spline. Part 2: Surfaces, *Comput. Aided Des.* 21 (1989) 538–546.
- [36] L. Piegl, W. Tiller, *The NURBS book*, Monographs in Visual Communication, Springer, Berlin, 1995, p. 646. ISBN 978-3-642-97385-7.
- [37] L. Piegl, W. Tiller, Computing offsets of NURBS curves and surfaces, *Comput. Aided Des.* 31 (1999) 147–156.
- [38] V. Patraucean, I. Armeni, M. Nahangi, J. Yeung, I. Brilakis, C. Haas, State of research in automatic as-built modelling, *Adv. Eng. Inform.* 29 (2) (2015) 162–171.
- [39] R. Quattrini, E.S. Malinverni, P. Clini, R. Nespeca, E. Orlietti, From TLS to HBIM. High quality semantically-aware 3D modeling of complex architecture, *Int. Arch. Photogramm. Rem. Sens. Spatial Inform. Sci.* XL-5/W4 (2015) 367–374.
- [40] Royas, et al., *Developing Best Practices for Capturing As-Built Building Information Models (BIM) for Existing Facilities*, 2009 Broad Agency Announcement, U.S. Army Engineer Research and Development Center (ERDC), CERL-15 Research Area, 2009, 86p.
- [41] H. Son, F. Bosché, C. Kim, As-built data acquisition and its use in production monitoring and automated layout of civil infrastructure: a survey, *Adv. Eng. Inform.* 29 (2) (2015) 172–183.
- [42] P. Tang, D. Huber, B. Akinci, R. Lipman, A. Lytle, Automatic reconstruction of as-built building information models from laser-scanned point clouds: a review of related techniques, *Automat. Constr.* 19 (2010) 829–843.
- [43] The Foundation of Wall and Ceiling Industry, *Building Information Modeling: Understanding and Operating in a New Paradigm*, Foundation of the Wall and Ceiling Industry, 513 West Broad Street, Suite 210, Falls Church, VA, 2009, p. 32.
- [44] C. Thomson, J. Boehm, Automatic geometry generation from point clouds for BIM, *Rem. Sens.* 7 (9) (2015) 11753–11775.
- [45] R. Volk, J. Stengel, F. Schultmann, Building information modeling (BIM) for existing buildings—literature review and future needs, *Automat. Constr.* 38 (2014) 109–127.
- [46] M. Zheliazkova, R. Naboni, I. Paoletti, A parametric-assisted method for 3D generation of as-built BIM models for the built heritage, *WIT Trans. Built Environ.* 153 (2015) 693–704.