

Warping influence on the static design of unbraced steel storage pallet racks

Claudio Bernuzzi*, Alice Pieri, Veronica Squadrito

Department of Architecture, Built Environment and Construction Engineering A.B.C., Politecnico di Milano, Italy

Received 10 September 2013
Received in revised form
21 January 2014
Accepted 28 January 2014
Available online 25 February 2014

1. Introduction

Thin-walled steel components for structural applications, formed from strips or coils by cold rolling processing, represent an important and growing area for the constructional steelwork field [1,2]. In civil engineering applications, their major use is for roof decks and curtain wall panels as well as for beams and beam-columns, which can form complete light-steel constructions for social housing and for other low-rise buildings [3,4]. As to industrial applications, cold formed steel members are frequently used to realize the skeleton frame of storage systems for goods and products, i.e., for storage pallet racks, which are the focus of the present work.

As shown in Fig. 1, pallet racks are composed by a regular sequence of upright frames, i.e., built-up laced members (Fig. 2), connected to each other in the down-aisle direction by pairs of horizontal beams sustaining pallet units. The lines of upright frames brace the storage system in the cross-aisle direction; each of them is independent between the floor level and the top from the contiguous lines, in order to keep free space for storing pallet units via automatic cranes or manual forklifts. The need to

optimize the rack performance in terms of stored goods generally hampers positioning bracing systems in the down-aisle direction. Stability to down-aisle loads is, hence, provided by the sole degree of flexural continuity associated with joints.

As to key features of rack components, it should be noted that:

- Columns or uprights (i.e., the chords of the built-up laced members) have in general a mono-symmetric C lipped cross-section, which is usually completed by additional lips (Fig. 3a) located at the end of the rear flanges used to bolt lacings to uprights (Fig. 3b). Uprights are positioned with their symmetry axis parallel to the cross-aisle direction; the shear centre of the cross-section is never coincident with the centroid. Furthermore, forces transferred through lacings are usually eccentric with reference to both centroid and shear centre of the upright cross-section.
- Beams or stringers (i.e., the elements sustaining pallets) can be divided into two types, depending on whether they are sensitive to lateral-torsional buckling (Fig. 4). The selection of a cross-section shape is usually governed by the need to guarantee adequate support to pallet units.
- Joints (i.e., the components connecting beams to columns and column bases to the industrial floor) can be distinguished into beam-to-column joints and base-plate connections. The former

* Corresponding author.

E-mail address: claudio.bernuzzi@polimi.it (C. Bernuzzi).

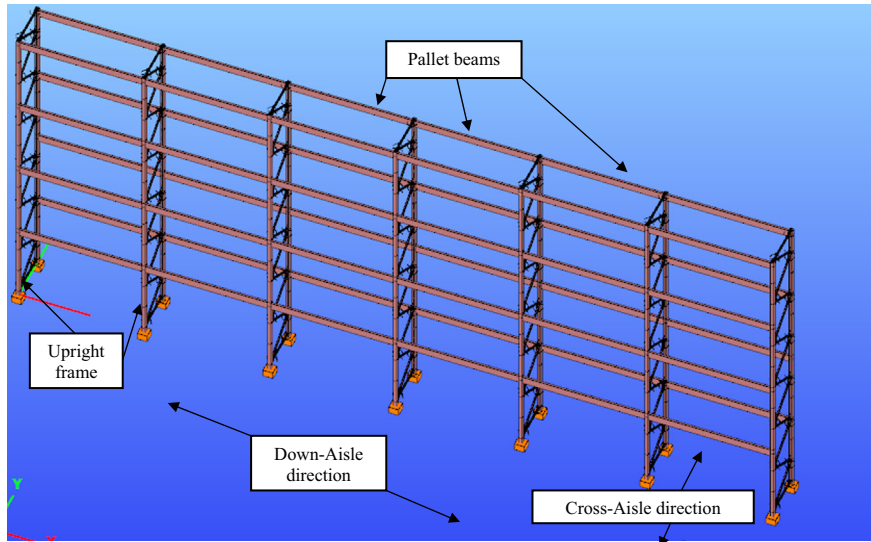

Fig. 1. Typical pallet rack configuration and key rack components.

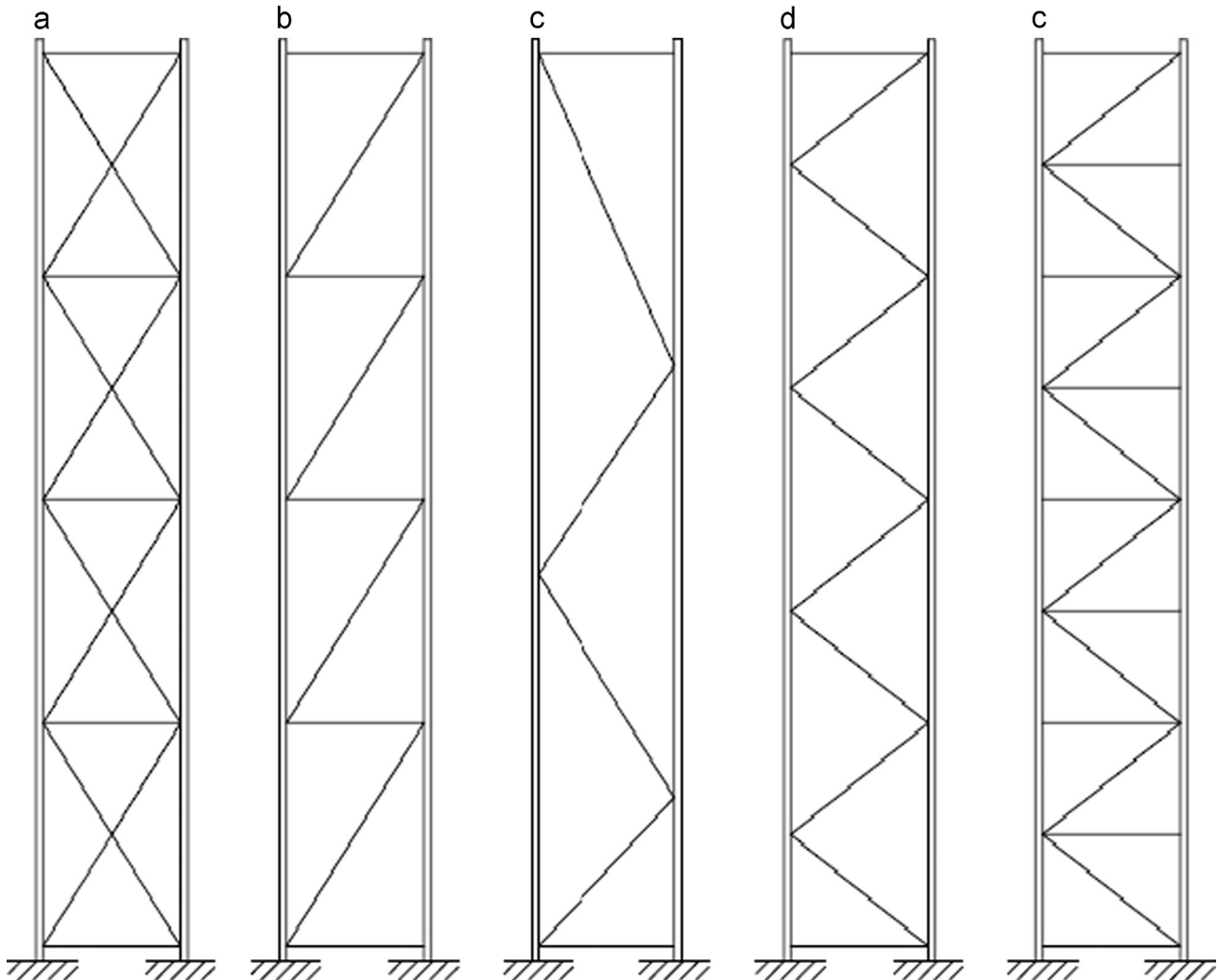

Fig. 2. Typical built-up laced columns used for upright frames: tension braced (a), "Z" braced (b), irregular "D" braced (c), regular "D" braced (d), and "K" braced (e) upright frames.

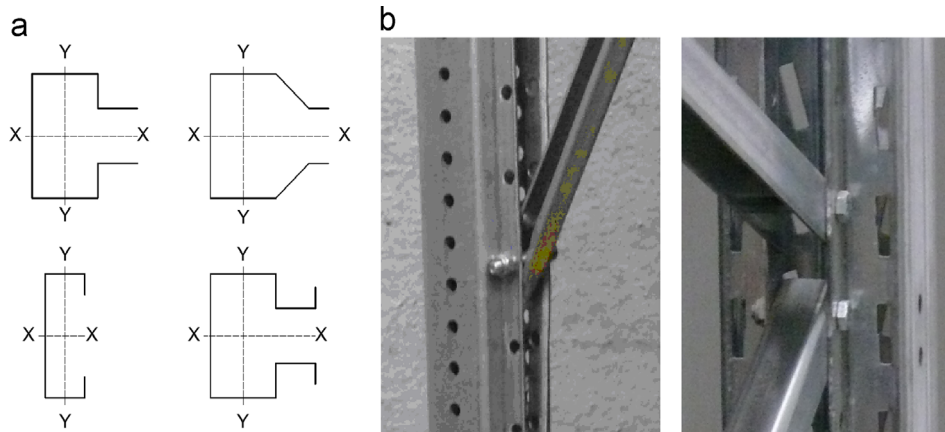

Fig. 3. Typical cross-section for uprights (a) and details of the nodal zone (b).

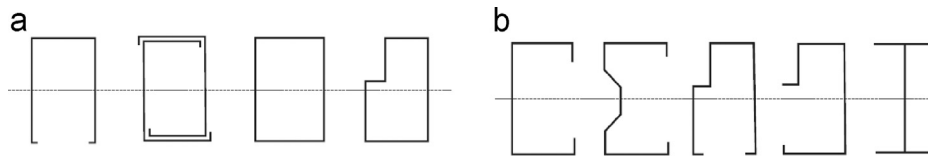

Fig. 4. Typical stringer cross-section in case of lateral torsional buckling not critical (a) or critical (b) for design.

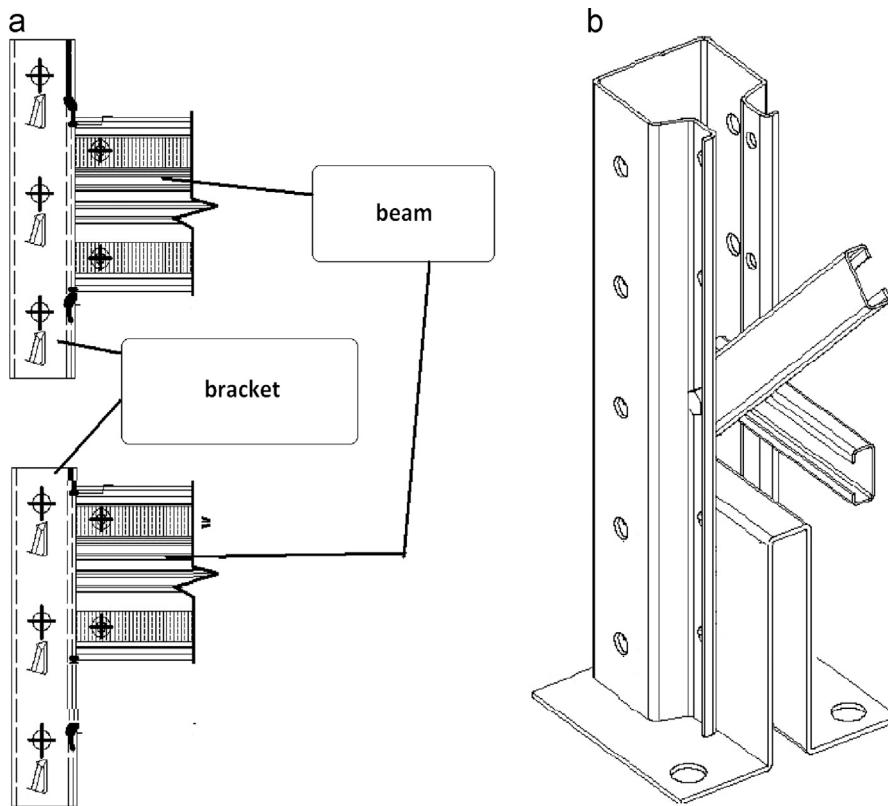

Fig. 5. Examples of beam-to-column joints (a) and base plate connections (b).

ones are usually realized by brackets welded to the beam ends and mechanically connected to uprights via hooks (Fig. 5a). Base-plate joints are realized by a formed steel plate, anchored to the industrial concrete floor and bolted to the upright end (Fig. 5b).

The response of steel storage pallet racks depends on several parameters, which reflects directly on the complexity of a rack design. Individual members are prone to different forms of

buckling, while the regular perforation systems of uprights increase the difficulties in the prediction of the component local behavior. Moreover, the presence of nonlinear partial strength semi-rigid connections, the non-negligible influence of second-order effects, and the geometrical and mechanical imperfections do not allow at present to base design on pure theoretical approaches. Tests aimed at the characterization of the structural key components are required. Because of the great variability of

member and joint geometries, pallet rack design is traditionally carried out by using hybrid procedures [5,6], which combine experiments with the state of knowledge developed for traditional steel structures. Design provisions have been very recently updated in Europe [7,8], in the United States [9] and in Australia and New Zealand [10]. As clearly stated by Rasmussen and Gilbert [11], this last, and most recent, code acknowledges that refined analyses should be based on shell element modeling, in order to express appropriately the effects of local and distortional buckling; it includes also other important provisions for analysis, suggesting advanced analysis approaches, which should incorporate the dominant nonlinear effects. Common structural 2D or 3D rack models employing beam elements at present may not consider correctly torsion, and in particular warping torsion. Furthermore, practical indications on the minimum technical requirements for the finite element (FE) analysis software programs, which appear necessary to guarantee an adequate safety level in design, are omitted in all these codes. It should be noted that in the past, on the basis of the authors' knowledge, only Teh et al. [12] focused their attention on the influence of warping on the structural analysis of racks. In particular, they investigated the implications of using "simple" 3D beam elements available in commercial frame analysis programs to determine the buckling load factor of a double-sided high-rise steel pallet rack frame.

A research program on the response of steel storage pallet racks is currently in progress at the Politecnico di Milano (I). Attention has up to now focused on the development of efficient strategies for the structural analysis and design of rack framed systems. The main outcomes of a parametric analysis aimed at appraising the influence of member warping on design are reported here. At first, the key features of structural analysis have been examined stressing the importance of a correct evaluation of the elastic critical load multiplier. The parametric analysis on medium-rise racks comprised four typical values of interstorey height for each of the six different upright frames commonly used in rack practice. For each of these 24 frame configurations, seven values of the degree of flexural stiffness of beam-to-column joints were considered. In total, 168 frames have been modeled; the relevant structural analyses have been performed by means of two commercial FE analysis programs, differing for the beam formulation: a FE analysis program for academic use [13] using traditional formulation with six degrees of freedom (6DOF) per node [14] and a commercial program including a more refined formulation with 7DOF per node capable to take into account also warping effects [15]. Finally, the European procedure to design racks [7] has been applied in order to appraise the differences in terms of safety level due to the use of these FE formulations. Attention is herein focused only on the static design. The influence of warping on the seismic response is described in a separated paper [16].

2. Structural design of racks

Steel storage pallet racks are realized by cold formed thin-walled members, the mono-symmetric open cross-section of which is in class 3 or 4, in accordance with the European classification criteria [17]: these cross-section classes are characterized by the absence of post-elastic resources and class 3 profiles are prone to local and/or distortional buckling in the elastic range. As a consequence plasticity cannot develop in members and an elastic approach, considering or not second-order effects depending on the rack stability to lateral load, must be adopted in structural analysis to determine internal forces and moments for structural verifications. The lack of bracings in the down-aisle direction generally affects significantly the internal forces and moments arising from the horizontal displacement of the nodes

and the overall frame response [18]. The type of structural analysis (i.e., first or second order) has to be selected in the initial phase of the design, as recommended by the modern approaches for the design of steel buildings under both static and seismic loads. From a practical point of view, this very important design choice depends on the value of the critical load multiplier α_{cr} , defined as the ratio between the elastic critical buckling load for the global instability mode (V_{cr}) and the total design vertical load of the structure (V_{Ed}), i.e., $\alpha_{cr} = V_{cr}/V_{Ed}$. In particular, the European rack specification [7] recommends the following:

- If $\alpha_{cr} \geq 10$ (or, equivalently, $V_{Ed}/V_{cr} \leq 0.1$), the rack system can be classified as a non-sway frame, being its response to design loads sufficiently stiff to neglect the effects associated with any additional internal forces or moments arising from horizontal nodal displacements. In this case, a first-order analysis is considered adequate for design purposes.
- If $3.33 \leq \alpha_{cr} < 10$ (or, equivalently, $0.1 < V_{Ed}/V_{cr} \leq 0.3$) the rack system is classified as a sway frame. As a consequence, second-order effects have to be taken into account, but can be treated indirectly, via simplified approaches, such as the *amplified sway moment method* [17].
- If $\alpha_{cr} < 3.33$ (or, equivalently, $V_{Ed}/V_{cr} > 0.3$), the rack system is a sway frame. Second-order effects must be directly considered in the structural analysis. In these cases, appropriate FE large displacement formulations are necessary to predict accurately the frame response.

The elastic load multiplier α_{cr} is usually evaluated by a buckling finite element analysis. Due to the presence of mono-symmetric cross-sections, the shear centre (point S in Fig. 6) does not coincide with the centroid (point O). Flexural-torsional buckling could occur before the flexural mode [19–22] as for all members with mono-symmetric cross-sections. As a consequence, buckling analysis has to capture the actual instability mode: from the computational point of view, appropriate beam element formulations, capable of accounting for warping, are necessary. Such elements are characterized by seven degrees of freedom per node (7DOF), i.e., three displacements (w_0 , u_s and v_s), three rotations (φ_x , φ_y , and φ_z) and the warping function θ , defined as

$$\theta = \theta(z) = -\frac{d\varphi_z}{dz} \quad (1)$$

Only the presence of the seventh degree of freedom θ allows to simulate the coupling between flexural and torsional buckling modes and to evaluate correctly internal forces and both bending and torsional moments. Furthermore, the warping function plays an important role also in evaluating correctly the actual local state of stress of uprights, as confirmed by [10], which includes bi-moment in upright verification checks, when racks are subjected to primary torsion action.

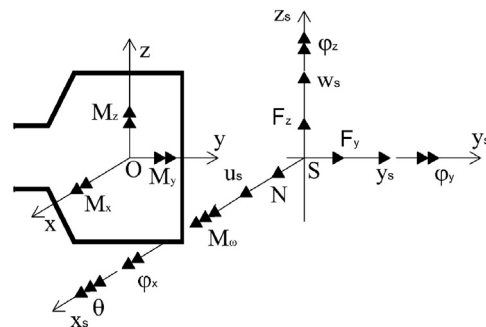

Fig. 6. Nodal displacements and internal forces for a beam element with 7DOF for each node.

Despite suitable beam formulations were already proposed in the literature in the last decades [22–24], a very limited number of FE programs offer libraries with beam elements characterized by 7DOF per node [15,25–27]. Some of these programs are not really efficient in representing accurately the complex behavior of open thin-walled sections [28].

Rack design is currently performed neglecting the warping influence also in case of warehouses [11]; no practical indications have been derived from research on the degree of safety of this design procedure. As a consequence, no practical indications related to the basic requirements for FE frame modeling via beam elements are reported in provisions for racks, as well as for cold formed steel structures in general. From a practical point of view, in many cases the current design procedure is based on a structural analysis selected via an incorrect elastic critical load multiplier, being it associated with the sole flexural modes. As to the member verification, checks for columns and beam-columns are developed by considering also torsional and flexural–torsional buckling load ($N_{cr,T}$ and $N_{cr,FT}$, respectively) using traditional approaches for isolated members [20,21] based on the values of the effective length coincident with the system length. In particular, by defining L_T the effective length for torsional buckling, classical theoretical expressions for mono-symmetric cross-section define these buckling loads as

$$N_{cr,T} = \frac{1}{i_0^2} \left[G \cdot I_t + \frac{\pi^2 E I_w}{L_T^2} \right] \quad \text{with } i_0^2 = i_x^2 + i_y^2 + x_0^2 \quad (2)$$

$$N_{cr,FT} = \frac{N_{cr,x}}{2\beta} \left[1 + \frac{N_{cr,T}}{N_{cr,x}} - \sqrt{\left(1 + \frac{N_{cr,T}}{N_{cr,x}} \right)^2 - 4 \left(\frac{x_0}{i_0} \right)^2 \frac{N_{cr,T}}{N_{cr,x}}} \right] \quad (3)$$

with $\beta = 1 - \left(\frac{x_0}{i_0} \right)^2$

where E and G are the elastic and shear moduli of the material, respectively, I_t is the torsional coefficient, I_w is the warping coefficient, and x_0 expresses the distance between shear centre and centroid along the x – x axis, which is the symmetry axis of the cross-section.

This procedure could be considered valid for the design of regular braced frames, for which the effective length associated with different buckling modes may be defined quite accurately and the possible influence of errors associated with incorrect buckling loads is quite limited. Most often, bracings are omitted in the down-aisle direction and a design based on results deriving from FE analysis considering only flexural second-order effects appears inadequate to guarantee an appropriate safety level, especially if the upright lacings are not an efficient restraint for uprights, reducing the effective length for stability verifications.

Furthermore, if a second-order elastic analysis is required, as typically occurs in rack practice, results from analysis based on 6DOF's or 7DOF's beam formulations are expected to be significantly different. A traditional 6DOF's beam formulation requires in fact the knowledge of the sole value of the internal axial load N , influencing the geometric stiffness matrix terms. Otherwise, in case of beam formulations including warping effects, also the values of the bending moments (M_y and M_z), torsional moment (M_t), bi-moment (B_w) and shear actions (F_y and F_z) contribute significantly to form the geometric stiffness matrix, the terms of which depend strictly also by the distance between the load application point and the shear centre eccentricity [22–24]. As a consequence in addition to difference on the overall buckling critical load of the frame, also horizontal displacements, internal forces and bending moments are significantly influenced by warping, especially in case of second-order analysis.

3. Warping influence on isolated members

Preliminarily to the parametric analysis on rack frames, an isolated channel member has been considered. The warping influence can be appraised with reference to the ratio between the flexural buckling load ($N_{cr,F}$) and the flexural–torsional one ($N_{cr,FT}$), $N_{cr,F}/N_{cr,FT}$. This ratio, indicated in the following as WBI (warping buckling influence), is plotted in Fig. 7 versus the effective length, L . Values lower than unity indicate that the dominant buckling mode is the flexural one; otherwise, when $WBI > 1$ (i.e., $N_{cr,F} > N_{cr,FT}$) the use of $N_{cr,F}$ instead of $N_{cr,FT}$ can lead to overestimate the latter, and, as a consequence, the design safety level. Cross-section data are presented in the figure. Three different values of the channel flange width, b (i.e., $b=60$ mm, $b=70$ mm and $b=80$ mm) have been considered, corresponding to different eccentricities between the shear centre and the centroid. The considered range of effective buckling length L (from 0.5 m to 5 m) has been selected with reference to situations of interest for rack practice. The lowest values of L are typically associated with upright stability checks for braced racks, while the highest are used for stability checks in the down-aisle direction for unbraced frames. It can be noted that

- a similar trend can be observed in all the plotted curves: with increasing values of the effective length, index WBI , or equivalently ratio ($N_{cr,F}/N_{cr,FT}$), decreases very slowly;
- a flexural–torsional buckling mode governs member instability in the range of practical interest. Only in case of $b=60$ mm for L

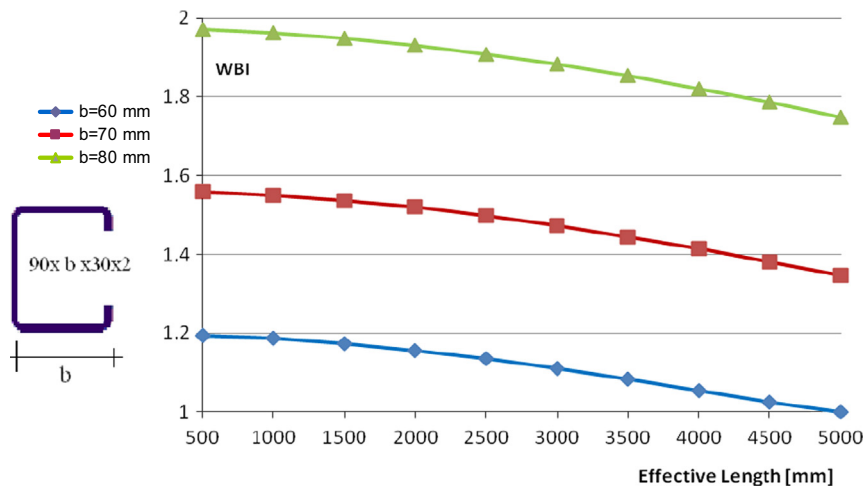

Fig. 7. Warping buckling influence (WBI) versus the effective length, where $WBI = N_{cr,F}/N_{cr,FT}$.

greater than 5 m, instability is associated with the flexural buckling mode;

- with the increase of the flange width (from $b=60$ mm to $b=80$ mm), ratio $N_{cr,F}/N_{cr,FT}$ increases significantly, due to the higher value of eccentricity between the shear centre and the centroid, which influences the degree of coupling between flexural and torsional buckling modes, via term i_0 of Eq. (2).

With reference to rack systems, i.e., to cases that are more general than an isolated member, ratio $N_{cr,F}/N_{cr,FT}$ measures also the error associated with the use of a traditional buckling analysis carried out by means of a 6DOF beam element instead of an analysis including warping influence (i.e., based on the use of a 7DOF beam element). As a consequence, an evaluation of the critical buckling load by using FE analysis programs capturing the sole flexural buckling modes can lead to very unconservative design for columns as well as for beam-columns. The European approach to design columns in traditional steel frames [17] as well as to design uprights of racks [7] evaluates the axial load carrying capacity as

$$N_{b,Rd} = \chi \cdot A_{eff} \frac{f_y}{\gamma_{M1}} \quad (4)$$

where A_{eff} is the effective cross-sectional area, f_y is the yielding strength of the material, γ_{M1} is the partial safety factor and χ is a reduction factor for the appropriate buckling mode defined as

$$\chi = \frac{1}{\varphi + \sqrt{\varphi^2 - \bar{\lambda}^2}} \quad \text{with } \chi \leq 1 \quad (5)$$

in which coefficient φ is expressed as

$$\varphi = 0.5 \cdot [1 + \alpha(\bar{\lambda} - 0.2) + \bar{\lambda}^2] \quad (6)$$

with $\alpha = 0.34$ for lipped channels or similar cross-sections.

The relative slenderness is defined as

$$\bar{\lambda} = \sqrt{\frac{A_{eff} \cdot f_y}{N_{cr}}} \quad (7)$$

where N_{cr} is the elastic critical load for the appropriate buckling mode (flexural, torsional, or flexural-torsional).

For the three lipped channel cross-sections in Fig. 7, the load carrying capacity has been evaluated by considering alternatively S250 and S350 steel grades [29]. Results are presented in Fig. 8 making reference to the warping reduction influence factor ($WRIF$), defined as the ratio χ^6/χ^7 where the apex indicates the number of DOF's per node used in the finite element formulation.

As for the WBI ratio, the $WRIF$ term measures also the error associated with the use of a software program inappropriate to model mono-symmetric cross-sections due to the impossibility to capture flexural-torsional buckling modes. In Fig. 8, the $WRIF$ ratio is plotted versus the effective length (L) for S250 steel (dashed line) and S350 steel (solid line). It can be noted that

- All the $WRIF-L$ relationships have a similar trend, characterized by the presence of a maximum value, which for $b=60$ mm and $b=70$ mm is reached in the considered range of L . Otherwise, the maximum is reached for values of L greater than 5 m, i.e. out of the range of interest for rack practice.
- Up to $L=1$ m, approximately, the reduction factor is 1 (i.e., $\chi_F = \chi_{FT} = 1$), owing to the limited value of relative slenderness $\bar{\lambda}$. In all the other cases, the reduction factor associated with the flexural buckling mode is significantly greater than that related to flexural-torsional one, confirming the significant influence of warping effects on the member design.
- The ratio χ_6/χ_7 depends strongly also from the steel grade. The largest values are associated with S350 steel, with an increment approximately up to 4% for $b=60$ mm and 14% for $b=80$ mm with respect to the S250 cases.

As a preliminary conclusion related to isolated members, it can be noted that warping effects influence significantly the performance of ideal (ratio WBI) as well as industrial isolated members (ratios WBI and $WRIF$) with a mono-symmetric cross-section.

When rack frames are considered, it is impossible to evaluate correctly N_{cr} via theoretical formulations. In case of regular frames made by bi-symmetric cross-section members, the elastic critical load can be evaluated on the basis of an approximate approach based on Horne's method [30]. This is recommended also by few rack Codes [10,17], despite on the basis of the authors' experience its degree of accuracy is not always adequate for routine design. As to rack design, a finite element buckling analysis has hence necessarily to be used. Important errors may be expected if inappropriate software programs are used when the flexural and torsional modes are coupled, resulting in a reduction of safety in design.

4. The rack frames considered for parametric analysis

Attention has been focused here on a typical medium-rise rack (Fig. 1): a total height of 6 m was considered for a six bay configuration (a bay span of 2.6 m) unbraced in the down-aisle

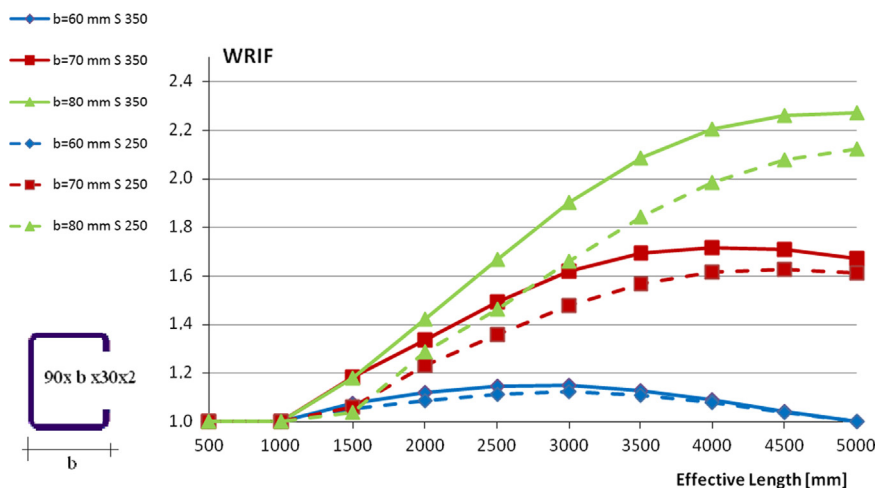

Fig. 8. Warping reduction influence factor ($WRIF$) versus the effective length, where $WRIF = (\chi_F/\chi_{FT})$.

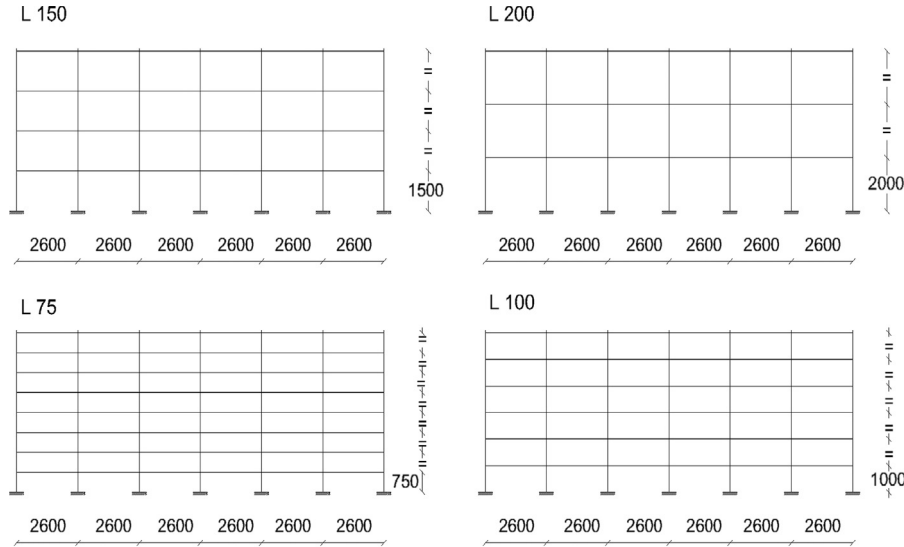

Fig. 9. Cross-aisle geometrical configuration of the frames considered in the structural analysis (all dimensions are in millimeter).

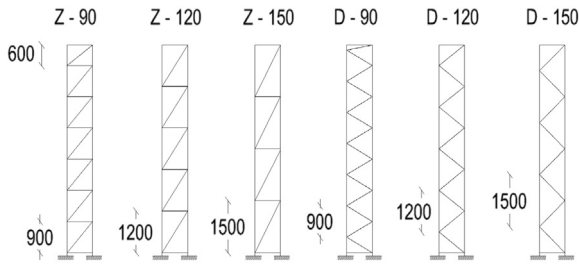

Fig. 10. Down-aisle geometrical configuration of the frames considered in the structural analysis.

direction (Figs. 9 and 10). Base plate joints have been modeled only as fixed in order to limit the number of variables influencing the frame response and better appraise warping effects. The rack components have been selected with reference to the most common type of cross-sections: lipped channel cross-section $90 \times 80 \times 30 \times 2$ mm has been used as uprights, already considered in Figs. 7 and 8, while hollow rectangular sections have been adopted for upright lacings ($30 \times 30 \times 3$ mm) and the pallet beams ($100 \times 50 \times 3$ mm).

Racks were considered fully loaded with pallet units giving an uniform load on beams. Overall frame imperfections equal to 0.0025 rad ($=1/400$ rad) in terms of out-of-plumb of the uprights in both the cross-aisle and the down-aisle directions have been considered to occur simultaneously. They have been simulated by means of horizontal forces concentrated at each floor level. The main parameters considered were the following:

- The configuration of the upright frame: Both a Z brace frame and a D brace frame, previously presented respectively in part (d) and (b) of Fig. 2, have been modeled; they are indicated in the following as Z- and B-frame, respectively.
- The geometry of the panel of the upright frame: Panels had different height, i.e., 0.9 m, 1.2 m and 1.5 m (identified in the following as 90, 120 and 150).
- The interstorey height: The values of 0.75 m, 1.0 m, 1.5 m and 2.0 m were considered for the height of the floor level, identified as -L75, -L100, -L150 and -L200. These values define frames differing in the number of stories: from three levels for -L200 racks to eight levels for -L75 racks.
- The degree of flexural stiffness associated with beam-to-column joints: The elastic rotational stiffness of beam-to-

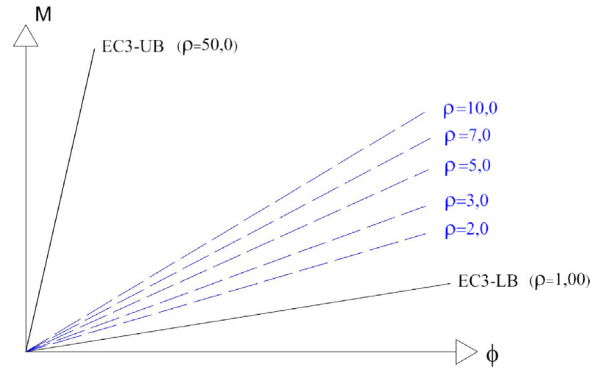

Fig. 11. Values of the rotational stiffness of beam-to-column joints considered in the analysis.

column joints, S_j , was based on the classification criteria of part 1-8 of EC3 [31]. In particular, the selected values of S_j have been defined as multiples (by means of term ρ) of a reference stiffness value S_j^{EC3-LB} as

$$S_j = \rho \cdot S_j^{EC3-LB} \quad (8a)$$

where S_j^{EC3-LB} is the stiffness associated with the lower bound of the semi-rigid domain, i.e., the stiffness corresponding to the transition between flexible and semi-rigid joints, which is defined by the code as

$$S_j^{EC3-LB} = 0.5 \frac{E \cdot I_b}{L_b} \quad (8b)$$

where E is the Young modulus, I_b is the second moment of area of beam section, and L_b is the beam length.

The stiffness parameter ρ has been considered in the present study ranging from 0 to 10 in order to reproduce the response of semi-rigid beam-to-column joints of practical interests for pallet racks [32]. As it appears from Fig. 11, which presents the considered values of the elastic rotational stiffness, in case of racks, beam-to-column joints have a moderate degree of rotational stiffness.

All the rack components were in class 3 profiles [17] made of S250 or S350 steel grade [29]: the first steel grade was used mainly in the past while S350 grade is the most commonly used steel grade for new applications. As previously mentioned, two commercial FE

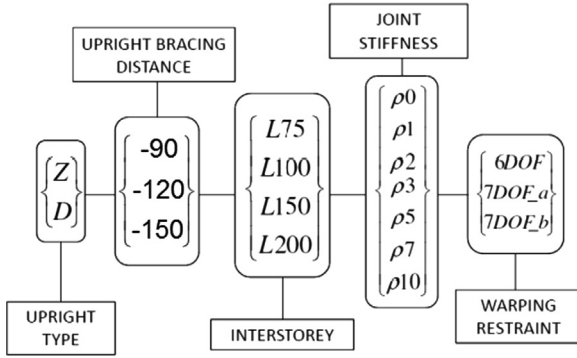

Fig. 12. Synopsis of the cases considered in the parametric analysis.

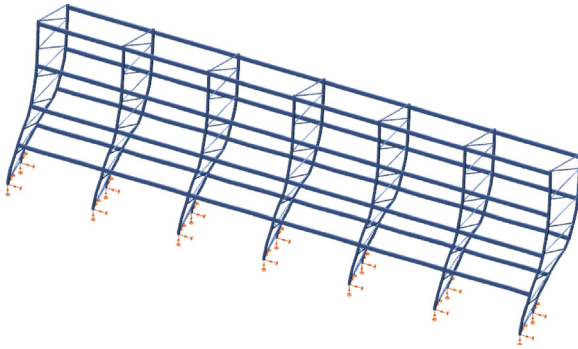

Fig. 13. Typical buckling mode obtained by using software [21] for case of frame Z-90 L200.

analysis software were considered for this study: a research program having a 6DOF beam element based on a traditional formulation [13,14] and Consteel [15], an efficient analysis software characterized by a 7DOF beam element implemented on the basis of the formulation described in Ref. [33]. As a consequence, the first program provides results typically associated with a beam formulation neglecting non-uniform torsion while warping effects are correctly accounted for in the Consteel results. Warping has been considered unrestrained for the upright top as well as for the bracing upright members, also in correspondence of the intersection with the upright. For the beam ends, due to the types of connectors commonly used in racks, warping was considered blocked. Fixed bases have been assumed as base-plate connections; furthermore, because of the different possibilities to connect the upright end to the industrial floor, i.e. due to the different types of base plate, both the cases of upright base with free (_a) and totally prevented (_b) warping have been considered in Consteel simulations.

Fig. 12 presents a summary of the performed analyses; the figure explains symbols used in the following.

5. Warping influence on elastic buckling

For all the rack frames, term α_{cr} has been evaluated by using both 6DOF's beam elements (α_{cr}^6) and 7DOF's beam elements (α_{cr}^7). Both cases of free and prevented warping at the base-plate connection (α_{cr}^{7-a} and α_{cr}^{7-b} , respectively) have been considered. As an example, Fig. 13 presents for frame Z-90 L200 the typical deformed shape for interaction between flexural and torsional buckling instabilities. Focusing on the errors associated with neglecting warping, Table 1 reports the values of ratios $\alpha_{cr}^6/\alpha_{cr}^{7-a}$ and $\alpha_{cr}^6/\alpha_{cr}^{7-b}$. They express the value of the warping buckling

index (*WBI*) for the two cases of base plate restraint, indicated in the following as WBI^a and WBI^b . The table presents also the mean value and the standard deviation of *WBI* for each value of the stiffness parameter ρ . Column bases restraining warping increase slightly the buckling resistance. As expected, values of $\alpha_{cr}^6/\alpha_{cr}^{7-a}$ are greater than the corresponding $\alpha_{cr}^6/\alpha_{cr}^{7-b}$. Yet, increasing the beam-to-column joint stiffness, the errors increase too, as can be observed also from Fig. 14. As a general remark, both *WBI* ratios are equal to unity for hinged beam-to-column joints ($\rho=0$), independently on the upright panel size and on the interstorey level, and increase significantly with increasing ρ values. As an example, in case of $\rho=5$ the mean value of the error due to neglecting warping ranges from 1.18 (L75) to 1.41 (L200) for free warping bases (WBI^a) and from 1.16 (L75) to 1.28 (L200) when warping is prevented (WBI^b). Moreover, the influence of the upright frame type (i.e., Z or D) and upright panel dimensions (i.e., -90, -120 and -150) are quite limited, in the range $\pm 5\%$. L200 frames are an exception with differences up to 10% if the upright base warping is free and up to 8% when the base warping is prevented.

Structural analysis made with 7DOF's beam elements allows also to appraise the influence of warping restraints at the base plate connection (i.e., free (a) or prevented (b) base warping). Reference can be directly made to the ratio $\alpha_{cr}^{7-b}/\alpha_{cr}^{7-a}$. This ratio increases with increasing joint stiffness (from $\rho=0$ to $\rho=10$) and interstorey height (from L75 to L200). For L75 (eight stories) and L100 (six stories) frames, term $\alpha_{cr}^{7-b}/\alpha_{cr}^{7-a}$ assumes quite limited values, slightly greater than unity, up to 1.04 for L75 racks and 1.08 for L100 racks, confirming the negligible warping influence on frames with limited storey heights. Otherwise, differences between the buckling multipliers α_{cr}^{7-a} and α_{cr}^{7-b} become significant, up to 18% and 24% for L150 and L200 racks, respectively.

Fig. 15 presents the mean value of the ratio $\alpha_{cr}^{7-b}/\alpha_{cr}^{7-a}$ plotted versus joint stiffness parameter ρ for all the considered cases. Initially these curves tend to be horizontal, up to $\rho=2$ for L75 and L100 frames and $\rho=1$ for L150 and L200 frames. By increasing ρ , the trend is approximately linear, with the slope increasing with the interstorey height.

6. Warping influence on the load carrying capacity

The degree of accuracy of the beam finite element used to model racks influences also the horizontal displacements as well as the internal forces and moments acting on the rack components, with direct consequences on the design reliability. Considering only the stability checks, in addition to axial force N_{Ed} uprights are generally subjected to bending moments acting in the down-aisle plane, $M_{x,Ed}$, due to the degree of continuity of beam-to-column joints, and $M_{y,Ed}$, acting in the cross-aisle direction and due to the eccentricity of the connections of the bracing members. According to European rack specifications [7], uprights are designed correctly if the safety index (*SI*) fulfils the following condition:

$$SI = \frac{N_{Ed}}{\frac{\chi_{\min} \cdot A_{eff} \cdot f_y}{\gamma_{M1}}} + \frac{k_x \cdot M_{x,Ed}}{\frac{W_{eff,x} \cdot f_y}{\gamma_{M1}}} + \frac{k_y \cdot M_{y,Ed}}{\frac{W_{eff,y} \cdot f_y}{\gamma_{M1}}} \leq 1 \quad (9)$$

where A_{eff} and W_{eff} indicate the area and the section modulus of the effective cross-section, respectively, f_y is the material yield strength, subscripts x and y identify the principal axes of the cross-section and γ_{M1} is the material safety factor. In accordance also with previous European standards [29], term k_j (where the subscript j corresponds either to the x - x or to the y - y axis) is defined

Table 1

Warping buckling influence for free warping $WPI^a = \alpha_{cr}^6 / \alpha_{cr}^{7-a}$ and for case fixed warping $WPI^b = \alpha_{cr}^6 / \alpha_{cr}^{7-b}$ at the base plate.

Rack	ρ	WPI^a						WPI^b						$\alpha_{cr}^6 / \alpha_{cr}^{7-a}$		$\alpha_{cr}^6 / \alpha_{cr}^{7-b}$	
		Z-90	D-90	Z-120	D-120	Z-150	D-150	Z-90	D-90	Z-120	D-120	Z-150	D-150	Mean	Dev	Mean	Dev
L75	0	1.000	1.000	1.000	1.000	1.000	1.000	1.000	1.000	1.000	1.000	1.000	1.000	1.000	0.000	1.000	0.000
	1	1.045	1.054	1.054	1.051	1.052	1.052	1.036	1.045	1.054	1.042	1.052	1.052	1.051	0.003	1.047	0.007
	2	1.079	1.091	1.092	1.090	1.089	1.094	1.079	1.085	1.085	1.084	1.089	1.088	1.089	0.005	1.085	0.004
	3	1.120	1.120	1.126	1.120	1.125	1.124	1.109	1.114	1.114	1.114	1.120	1.118	1.123	0.003	1.115	0.004
	5	1.173	1.181	1.181	1.180	1.185	1.182	1.154	1.163	1.163	1.162	1.166	1.163	1.180	0.004	1.162	0.004
	7	1.222	1.226	1.230	1.224	1.228	1.230	1.192	1.200	1.200	1.199	1.202	1.200	1.227	0.003	1.199	0.003
	10	1.276	1.279	1.283	1.282	1.282	1.284	1.232	1.239	1.239	1.238	1.242	1.239	1.281	0.003	1.238	0.003
L100	0	1.000	1.000	1.000	1.000	1.000	1.000	1.000	1.000	1.000	1.000	1.000	1.000	1.000	0.000	1.000	0.000
	1	1.042	1.031	1.074	1.074	1.074	1.073	1.033	1.031	1.065	1.065	1.065	1.064	1.061	0.020	1.054	0.017
	2	1.076	1.078	1.122	1.121	1.121	1.121	1.069	1.072	1.108	1.108	1.114	1.114	1.107	0.023	1.098	0.021
	3	1.126	1.125	1.168	1.166	1.167	1.171	1.105	1.103	1.145	1.149	1.149	1.148	1.154	0.022	1.133	0.023
	5	1.202	1.199	1.251	1.249	1.250	1.248	1.155	1.157	1.206	1.209	1.210	1.207	1.233	0.025	1.191	0.027
	7	1.268	1.265	1.318	1.312	1.313	1.316	1.198	1.199	1.251	1.250	1.251	1.253	1.299	0.025	1.234	0.027
	10	1.346	1.351	1.404	1.390	1.394	1.395	1.244	1.248	1.301	1.298	1.301	1.298	1.380	0.025	1.282	0.028
L150	0	1.000	1.000	1.000	1.000	1.000	1.000	1.000	1.000	1.000	1.000	1.000	1.000	1.000	0.000	1.000	0.000
	1	1.052	1.053	1.105	1.105	1.114	1.106	1.044	1.044	1.096	1.096	1.105	1.097	1.089	0.029	1.080	0.028
	2	1.122	1.116	1.191	1.176	1.205	1.176	1.090	1.090	1.149	1.154	1.161	1.148	1.164	0.037	1.132	0.033
	3	1.191	1.179	1.267	1.239	1.279	1.240	1.134	1.134	1.197	1.195	1.213	1.196	1.233	0.040	1.178	0.035
	5	1.313	1.295	1.408	1.352	1.422	1.352	1.202	1.196	1.269	1.271	1.292	1.266	1.357	0.050	1.249	0.040
	7	1.408	1.388	1.523	1.438	1.527	1.450	1.247	1.245	1.325	1.320	1.345	1.315	1.456	0.058	1.300	0.043
	10	1.522	1.498	1.641	1.539	1.643	1.571	1.302	1.298	1.388	1.371	1.405	1.372	1.569	0.061	1.356	0.045
L200	0	1.000	1.000	1.000	1.000	1.000	1.000	1.000	1.000	1.000	1.000	1.000	1.000	1.000	0.000	1.000	0.000
	1	1.063	1.058	1.128	1.118	1.144	1.127	1.047	1.050	1.109	1.109	1.116	1.117	1.106	0.037	1.091	0.033
	2	1.144	1.132	1.231	1.208	1.264	1.207	1.105	1.106	1.179	1.179	1.187	1.185	1.198	0.051	1.157	0.040
	3	1.205	1.191	1.322	1.286	1.369	1.277	1.146	1.145	1.232	1.232	1.246	1.236	1.275	0.068	1.206	0.047
	5	1.320	1.330	1.474	1.416	1.537	1.413	1.214	1.208	1.308	1.307	1.326	1.304	1.415	0.083	1.278	0.052
	7	1.398	1.446	1.583	1.508	1.656	1.525	1.257	1.246	1.363	1.356	1.380	1.352	1.519	0.093	1.326	0.058
	10	1.483	1.558	1.690	1.605	1.780	1.630	1.299	1.288	1.409	1.402	1.441	1.398	1.624	0.103	1.373	0.063

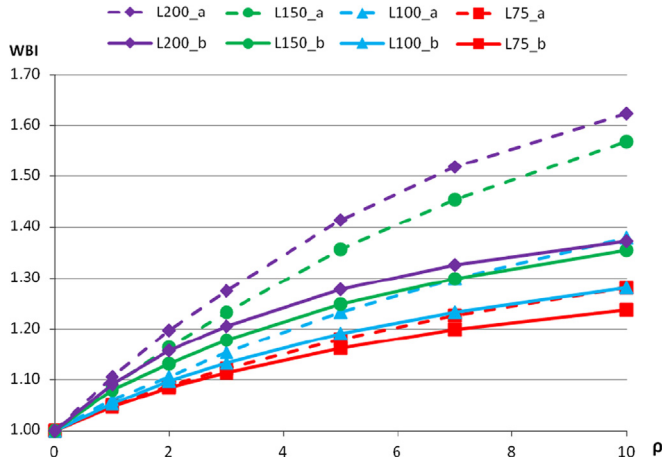

Fig. 14. Mean values of warping buckling index ($WBI = \alpha_{cr}^6 / \alpha_{cr}^{7-a}$) versus joint stiffness: warping free (a) and warping prevented (b).

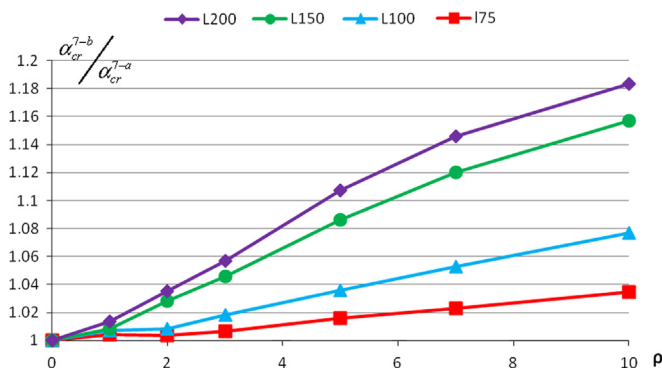

Fig. 15. Influence of the warping at the column base on the elastic critical load multipliers: warping free (a) and warping prevented (b).

as

$$k_j = \min \left[1.5; 1 - \frac{\mu_j \cdot N_{Ed}}{\chi_j \cdot A \cdot f_y} \right] \quad (10a)$$

The non-dimensional term μ_j is evaluated as

$$\mu_j = \min [0.9; \bar{\lambda}_j \cdot (2\beta_{Mj} - 4)] \quad (10b)$$

The coefficient β_{Mj} in Eq. (10b) takes into account the bending moment distribution along the longitudinal upright axis. In case of linear bending distributions, if $M_{j,Ed,M}$ and $M_{j,Ed,m}$ indicate the bending moments at the upright ends (with $M_{j,Ed,M} > M_{j,Ed,m}$), the term β_{Mj} is given by the following expression:

$$\beta_{Mj} = 1.8 - 0.7 \frac{M_{j,Ed,M}}{M_{j,Ed,m}} \quad (10c)$$

Both terms k_j and χ depend on the relative upright slenderness $\bar{\lambda}_j$ (Eq. (7)). This is strictly influenced by warping effects and, as previously mentioned, can be directly identified only in a regular braced rack. In case of sway racks two possible approaches can be adopted: the use of theoretical formulas for isolated partially end restrained columns, or a FE buckling analysis. Being impossible to evaluate α_{cr} and $\bar{\lambda}_j$ correctly for racks unbraced in the down-aisle direction, where the system length is not adequate for buckling checks [34], the second approach has been here followed. Verifications have been executed on the basis of internal forces and moments obtained from the two considered FE approaches with reference to the more stressed uprights. In case of 6DOF's beam elements, the critical load multiplier α_{cr}^6 obtained from the FE buckling analysis is associated only with the flexural modes; flexural buckling load is evaluated as the product between the elastic critical load multiplier and the design axial load $N_{Ed,j}$. As a consequence, Eqs. (2) and (3) have been used to take into account the influence of pure torsional and coupled flexural-torsional

buckling loads basing verification on the system length. It should be noted that this procedure is recommended also by the rack Australian standards [10] when a geometric linear analysis is executed. In the authors' expertise, the use of the system lengths as directly recommended by [7] leads to unsafe design when flexural buckling modes are dominant as well as when bi-symmetric cross sections are used. With reference to the most common open cross-section uprights (Fig. 3), the critical load is the flexural-torsional one, which is evaluated on the upright considered as an isolated member.

If a 7DOF's beam element is used, the critical load multiplier, already used to select the analysis method, takes directly into account also the possible buckling modes of the upright and $N_{cr,j}$ is directly evaluated as $N_{cr,j} = \alpha_{cr} \cdot N_{Ed,j}$.

For the frames considered in the study as well as for the case of isolated compression upright (Fig. 8), reference has been made to two different steel grades, S250 and S350 steel grade, in the evaluation of safety index. Even if numerical simulations were all carried out by considering both the cases of free warping ($-a$) and prevented warping ($-b$) at the base plate, in the following, given the limited differences between the values of SI^{7-a} and SI^{7-b} , only the results associated with the case $-a$ are discussed. Tables 2 and 3 present the design results with reference to parameter DWI (design warping influence), defined as the ratio SI^{7-a}/SI^6 , i.e., the ratio between the safety index SI associated with a 7DOF analysis (SI^{7-a}) and the one associated with a 6DOF analysis (SI^6). The mean value and standard deviation are reported for each set of racks having the same value of joint stiffness parameter ρ and the same interstorey level. When DWI is greater than unity, neglecting warping effects leads to an overestimation of the load carrying capacity. If DWI is lower than unity, the use of a 6DOF analysis software and torsional/flexural-torsional buckling check based on

Table 2
Values of DWI for rack frames made of S250 steel grade ($DWI = (SI^{7-a}/SI^6)$).

Rack	ρ	Z-90	D-90	Z-120	D-120	Z-150	D-150	Mean	Dev	
L75	0	1.04	1.03	1.04	0.98	1.01	1.01	1.02	0.02	
	1	0.99	1.05	1.00	1.05	1.05	0.98	1.02	0.03	
	2	0.98	1.04	1.02	1.06	1.06	1.05	1.03	0.03	
	3	0.99	1.06	1.02	1.06	1.06	1.04	1.04	0.03	
	5	1.00	1.10	1.03	1.06	1.06	1.03	1.05	0.03	
	7	1.01	1.08	1.04	1.06	1.07	1.03	1.05	0.03	
	10	1.01	1.10	1.05	1.06	1.07	1.02	1.05	0.03	
	Mean	0.993	1.055	1.027	1.044	1.055	1.025			
	L100	0	1.07	0.94	0.98	0.94	1.00	0.99	0.99	0.05
		1	1.00	1.05	0.99	1.05	1.04	1.01	1.02	0.03
2		1.01	1.06	1.01	1.06	1.05	1.05	1.04	0.02	
3		1.00	1.06	1.02	1.06	1.06	1.06	1.05	0.03	
5		1.04	1.08	1.05	1.08	1.08	1.07	1.07	0.02	
7		1.06	1.09	1.07	1.09	1.09	1.09	1.08	0.01	
10		1.09	1.11	1.11	1.11	1.11	1.11	1.11	0.01	
Mean		1.021	1.044	1.026	1.044	1.043	1.045			
L150		0	0.96	1.02	0.95	0.99	0.99	0.98	0.98	0.02
		1	1.00	1.04	1.00	1.05	1.01	1.02	1.02	0.02
	2	1.02	1.06	1.04	1.07	1.04	1.04	1.05	0.02	
	3	1.05	1.09	1.08	1.10	1.07	1.06	1.07	0.02	
	5	1.11	1.14	1.15	1.14	1.13	1.10	1.13	0.02	
	7	1.17	1.22	1.23	1.18	1.18	1.14	1.19	0.03	
	10	1.25	1.25	1.38	1.24	1.25	1.21	1.26	0.06	
	Mean	1.077	1.117	1.118	1.108	1.095	1.079			
	L200	0	0.95	1.06	0.97	0.97	0.99	0.98	0.99	0.04
		1	0.98	1.06	1.04	1.05	1.04	1.03	1.03	0.03
2		1.01	1.09	1.10	1.09	1.10	1.07	1.08	0.03	
3		1.04	1.12	1.16	1.13	1.16	1.10	1.12	0.04	
5		1.12	1.20	1.27	1.21	1.27	1.17	1.21	0.06	
7		1.17	1.28	1.37	1.28	1.36	1.24	1.28	0.08	
10		1.23	1.37	1.39	1.36	1.39	1.32	1.34	0.06	
Mean		1.063	1.168	1.186	1.156	1.1	1.130			

Table 3
Values of DWI for rack frames made of S350 steel grade ($DWI = (SI^{7-a}/SI^6)$).

Rack	ρ	Z-90	D-90	Z-120	D-120	Z-150	D-150	Mean	Dev	
L75	0	0.95	1.000	1.04	0.97	1.02	1.02	1.00	0.03	
	1	0.98	1.03	1.00	1.04	1.03	0.96	1.01	0.03	
	2	0.98	1.03	1.02	1.05	1.05	1.05	1.03	0.03	
	3	0.99	1.05	1.02	1.06	1.06	1.04	1.04	0.03	
	5	1.00	1.10	1.03	1.06	1.07	1.04	1.05	0.03	
	7	1.02	1.09	1.05	1.07	1.07	1.04	1.06	0.02	
	10	1.03	1.11	1.06	1.07	1.08	1.04	1.07	0.03	
	Mean	0.983	1.044	1.025	1.039	1.043	1.023			
	L100	0	1.00	1.00	0.98	0.96	1.01	1.00	0.99	0.02
		1	0.99	1.03	0.98	1.03	1.02	0.98	1.00	0.02
2		1.00	1.03	1.00	1.04	1.04	1.04	1.02	0.02	
3		1.00	1.05	1.01	1.05	1.05	1.06	1.04	0.03	
5		1.04	1.10	1.04	1.08	1.07	1.07	1.07	0.02	
7		1.06	1.09	1.07	1.09	1.09	1.09	1.08	0.01	
10		1.10	1.11	1.11	1.12	1.12	1.12	1.11	0.01	
Mean		1.007	1.044	1.017	1.037	1.034	1.035			
L150		0	1.01	1.01	0.92	0.97	1.00	0.99	0.98	0.03
		1	0.97	1.03	0.98	1.03	0.98	0.99	1.00	0.03
	2	0.99	1.06	1.02	1.05	1.01	1.01	1.03	0.03	
	3	1.02	1.08	1.06	1.08	1.04	1.04	1.05	0.02	
	5	1.08	1.14	1.15	1.13	1.11	1.08	1.11	0.03	
	7	1.14	1.23	1.23	1.18	1.16	1.13	1.18	0.04	
	10	1.23	1.26	1.38	1.24	1.23	1.19	1.25	0.07	
	Mean	1.062	1.114	1.105	1.097	1.077	1.062			
	L200	0	0.96	0.92	1.03	1.02	0.92	1.01	0.98	0.05
		1	0.94	1.05	1.03	1.03	1.02	1.01	1.01	0.04
2		0.97	1.08	1.09	1.08	1.08	1.05	1.06	0.05	
3		1.00	1.12	1.15	1.12	1.14	1.08	1.10	0.06	
5		1.07	1.20	1.27	1.21	1.26	1.16	1.19	0.07	
7		1.12	1.29	1.37	1.28	1.35	1.23	1.27	0.09	
10		1.19	1.38	1.39	1.36	1.39	1.32	1.34	0.08	
Mean		1.035	1.148	1.190	1.158	1.165	1.121			

the system length can lead to a conservative design and, as a consequence, to an upright oversizing.

At first, a comment on the evaluation of the axial critical load is due: the 6DOF's approach, i.e., flexural buckling load evaluated directly by means of α_{cr}^6 and flexural-torsional equations (Eqs. (2) and (3)) used for an isolated member, should lead to assess a value of the elastic critical load lower than the one associated with the 7DOF's approach. As a consequence, the 6DOF's design procedure should appear more severe than the 7DOF's one when reference is made to columns, i.e., to members subjected to the sole axial load. Furthermore, the non-negligible differences in the values of the safety indices reported in Tables 2 and 3 are due to the different value of the bending moments, in many cases, significantly greater than the one obtained when warping effects are neglected.

As already observed with reference to the buckling results, it appears that the type of upright lacing panel and its height have a quite limited influence also for design. Therefore, DWI values have been grouped by value of interstorey level. Each of Figs. 16–19 reports, for one of the four considered values of the interstorey level, the single value of DWI versus joint stiffness (ρ) together with the curve obtained by plotting the mean value of DWI . Independently of steel grades, from tables and figures it can be noted that:

- The DWI is in general greater than unity, confirming the importance of warping for a safe design. In a few cases, DWI is slightly lower than unity, up to 0.92, mainly with reference to racks with hinged beam-to-column joints. In a very limited number of other cases DWI is lower than unity but, in any case, greater than 0.94. $DWI \leq 1$ is due to the fact that internal forces and bending moments determined via a 7DOF's finite element beam formulation can result slightly lower than those obtained

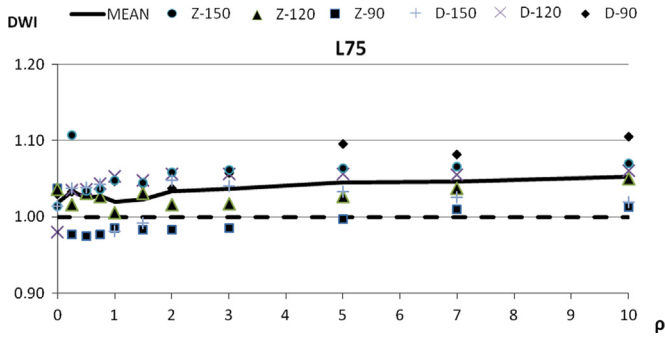

Fig. 16. Values of DWI for frames with an interstorey height of 0.75 m (L75) in S250 steel grade ($DWI = (SI^7 - a) / SI^6$).

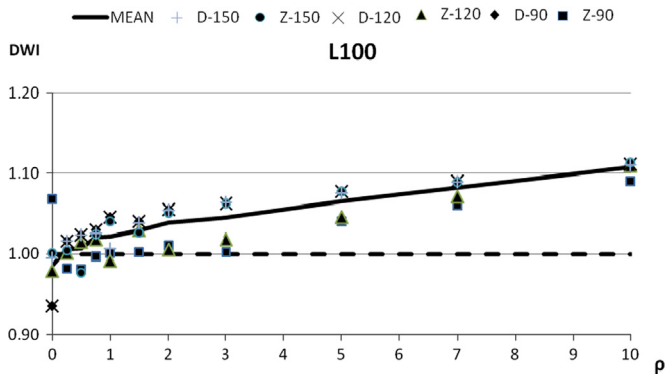

Fig. 17. Values of DWI for frames with an interstorey height of 1.00 m (L100) in S250 steel grade ($DWI = (SI^7 - a) / SI^6$).

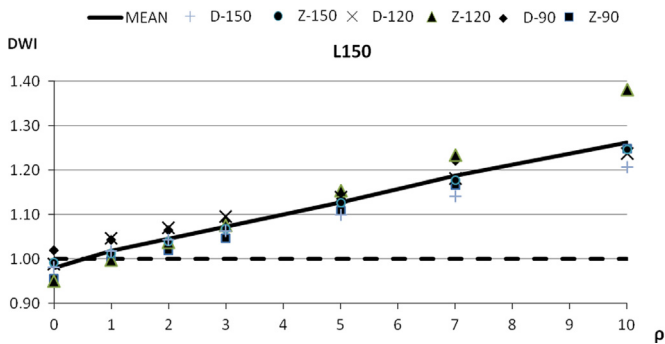

Fig. 18. Values of DWI for frames with an interstorey height of 1.50 m (L150) in S250 steel grade ($DWI = (SI^7 - a) / SI^6$).

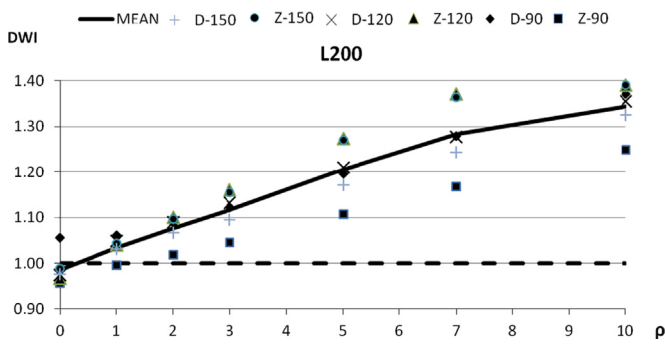

Fig. 19. Values of DWI for frames with an interstorey height of 2.00 m (L200) in S250 steel grade ($DWI = (SI^7 - a) / SI^6$).

neglecting warping, being the rack response more flexible than when determined via a 6DOF FE analysis. In these cases the use of system length can lead to a modest oversizing of racks.

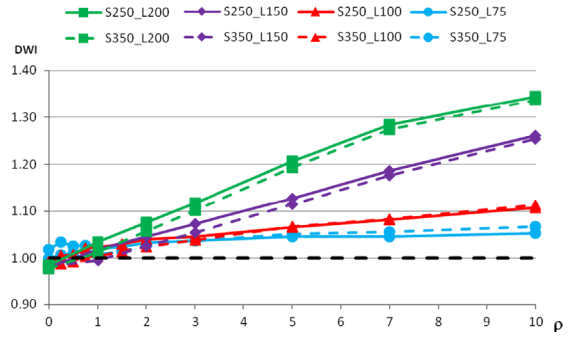

Fig. 20. Values of DWI for each frames with interstorey height of 0.75 m (L75), 1.00 m (L100), 1.50 m (L150) and 2.00 m (L200) in S250 and S350 steel grade; ($DWI = (SI^7 - a) / SI^6$).

- Increasing the values of ρ as well as the storey height, term DWI increases reaching absolutely non-negligible values. For $\rho=10$ the mean value of DWI ranges from 1.05 for L75 to 1.34 for L200 frames. This demonstrates clearly that neglecting warping appears to be dangerous and unsafe.
- As to the mean values reported in Tables 2 and 3, DWI 's lower than unity are related only to the cases of hinged beam-to-column joints. All the other data have a very moderate dispersion with reference to the mean value. Standard deviation is generally not greater than 0.05 except for a very limited number of cases (for L150 and L200 racks), for which standard deviations up to 0.09 have been calculated.

The plotted data are related to the case of S250 steel but these comments maintain their validity also for racks in the S350 steel, as it can be noted from Fig. 20, which compares the mean $DWI-\rho$ relationship for S250 (dashed line) and for S350 (solid line) steel grade. $DWI-\rho$ curves associated with the S350 steel grade are very similar to the S250 ones; as expected, differences decrease with increasing ρ and interstorey level. Furthermore, these curves present a similar monotonic trend: the slope is approximately constant for each set of the racks having the same interstorey height and increases with the increase of the interstorey height. The solid line in correspondence of the unity confirms clearly that structural analyses neglecting warping lead to very unconservative design.

7. Concluding remarks

This paper deals with unbraced racks, which are semi-continuous frames realized by mono-symmetric cross-section members used as uprights, and attention has been focused on the influence of the cross-section warping. The response of several selected frame configurations of interest for rack practice has been considered; a parametric study has been carried out by using two FE analysis software programs differing in the nodal degree of freedoms considered in the implemented beam formulation. With reference to the European design approach [7], design results of a traditional 6DOF analysis have been compared with those from a more refined formulation considering warping effects, i.e. characterized by 7DOF per node.

On the basis of the analysis of 168 different rack configurations, it has been demonstrated that the critical load multiplier (α_{cr}) is significantly influenced by warping effects. Increasing the degree of semi-continuity of beam-to-column joints, the importance of coupling between flexural and torsional mode increases too, and differences are absolutely non-negligible. Incorrect assessment of the elastic critical load multiplier due to the use of an inappropriate beam element formulation reflects directly on the choice of the

analysis method as well as on reliability of the main verification checks. Warping effects (i.e., Wagner's coefficients, warping deformations, shear center eccentricity and the coupling between flexure and torsion) influence significantly the values of the internal forces and moments, together with the frame deformability. Verification design checks based on a traditional 6DOF's FE program can lead to a slight oversizing of the frame components only in a very limited number of cases, when racks have very flexible beam-to-column joints and/or in case of a modest inter-storey height. Otherwise, if a second-order analysis is required, design can result significantly unsafe, being the load carrying capacity greatly overestimated (up to 40%), if warping effects are neglected.

As a general conclusion, it can be pointed out that the effects of warping have to be necessarily taken into account in numerical analysis using a suitable beam formulation in order to achieve the goal of a safe design. In addition, it should be noted that these research outcomes, which have been obtained with reference to racks, have a more general validity. This extends to frames or sub-frame systems realized with members having the centroid not coincident with the shear center. Standard provisions should be updated in order to include minimum requirements for beam formulation in a finite element analysis.

A significant warping influence is expected also for seismic design, which is the topic of a separate article [16].

References

- [1] Shafer BW. Cold-formed steel structures around the world – a review of recent advances in applications, analysis and design. *Steel Constr* 2011;4:141–9.
- [2] Ghersi A, Landolfo R, Mazzolani FM. Design of metallic cold-formed thin-walled members. first ed.. London: Spon Press; 2002; 164.
- [3] Wei-Wen Yu. Cold-formed steel design. New York: John Wiley & Sons; 2000.
- [4] Godley MHR. Design of cold formed steel members, Rhodes ed.; 1991. p. 361–99.
- [5] Baldassino N, Zandonini R. Design by testing of industrial racks. *Adv Steel Constr* 2011;7(1):27–47.
- [6] Baldassino N, Bernuzzi C, Tardini C. On the European practice for the design procedure of industrial steel storage pallet racks. *J Constr Steel Res*, submitted for publication, 2014.
- [7] CEN, EN 15512. Steel static storage systems – adjustable pallet racking systems – principles for structural design, CEN European Committee for Standardization; 2009. p. 137.
- [8] Federation Européenne de Manutention, FEM 10.2.08 – recommendations for the design of static steel storage pallet racks in seismic conditions; September 2010, version 1.00.
- [9] RMI, MH 16.1 – specification for the design, testing and utilization of industrial steel storage racks. RMI – Rack Manufacturers Institute; 2008. p. 59.
- [10] Australian Standards, AS 4084 – steel storage racking, AS standards, Australia; 2012.
- [11] Rasmussen KJR, Gilbert BP. Analysis-based design provisions for steel storage racks. *J Struct Eng ASCE* 2013;139(May):849–59.
- [12] Teh LH, Hancock GJ, Clarke MJ. Analysis and design of double sided high-rise steel pallet rack frames. *J Struct Eng* 2004;130:1011–21.
- [13] Bathe KJ, Wilson EL, Iding RH. NONSAP-finite element calculation for non-linear static and dynamic analysis of complex structures. Berkeley, CA, USA: Structural Engineering Laboratory, University of California; 1978.
- [14] Hughes TJR. The finite element methods. Upper Saddle River, New Jersey: Prentice-Hall, Inc.; 1987.
- [15] ConSteel 6.0: Finite-element-program. Consteel Solutions Ltd, (<http://www.consteel.hu>).
- [16] Bernuzzi C, Gobetti A, Gabbianelli G, Simoncelli M. Warping influence on the seismic design of steel storage pallet racks, in preparation, 2014.
- [17] CEN, Eurocode 3 – design of steel structures – part 1-1: general rules and rules for buildings, CEN European Committee for Standardization; 2005. p. 91.
- [18] Baldassino N, Bernuzzi C. Analysis and behaviour of steel storage pallet racks. *Thin Walled Struct* 2000;37(4):277–304.
- [19] Ballo G, Mazzolani FM. Theory and design of steel structures. London: Chapman & Hall; 1983.
- [20] Timoshenko SP, Gere JM. Theory of elastic stability. second ed.. New York: McGraw Hill; 1961.
- [21] Vlasov VZ. Thin walled elastic beams, second ed. Israel Program for Scientific Transactions, National Technical Information Service, Jerusalem; 1961.
- [22] Chen WF, Atzuta T. Theory of beam-columns. Vol. 2: space behaviour and design. New York: McGraw Hill; 1977.
- [23] Turkalj G, Brnic J, Prpic-Orsic J. Large rotation analysis of elastic thin walled beam-type structures using ESA approach. *Comput Struct* 2003;81:1851–64.
- [24] Battini JM. Co-rotational beam elements in instability problems. Technical report from Royal Institute of Technology Department of Mechanics, Stockholm, Sweden; January 2002.
- [25] ABAQUS/STANDARD user's manual version 6.8, Hibbit, Karlsson and Sorensen, USA; 2006.
- [26] LS-DYNA, (http://www.ls-dyna.com/1_pages/1lsdyna.htm).
- [27] The SOFiSTiK FEM Packages, (<http://www.sofistik.com/en/>).
- [28] Mohri F, Brouki A, Roth JC. Theoretical and numerical stability analyses of unrestrained, mono-symmetric thin-walled beams. *J Constr Steel Res* 2003;59:63–90.
- [29] CEN EN 10025: hot rolled products of structural steels – part 1-6.
- [30] Horne MR. An approximate method for calculating the elastic critical loads of multi-storey plane frame. *Struct Eng* 1975;53(6):242–8.
- [31] CEN European Committee for Standardization, EN 1993-1-8. Eurocode 3 – design of steel structures – part 1-8: design of joints, CEN, Brussels; May 2005.
- [32] Baldassino N, Bernuzzi C, Zandonini R. Performance of joints in steel storage pallet racks. In: International conference on connections in steel structures IV: steel connections in the new millennium; 22–25 October 2000, Roanoke, VI.
- [33] Papp F, Iványi M, Jármai K. Unified object-oriented definition of thin-walled steel beam-column cross-sections. *Comput Struct* 2001;79:839–52.
- [34] Bernuzzi C, Baldassino N, Zandonini R. Design analysis of steel storage pallet racking systems. In: XVII Convegno C.T.A., Collegio dei Tecnici dell'Acciaio, Napoli; ottobre 1999 [in Italian].