



**POLITECNICO**  
MILANO 1863

[RE.PUBLIC@POLIMI](mailto:RE.PUBLIC@POLIMI)

Research Publications at Politecnico di Milano

## Post-Print

This is the accepted version of:

S. Ricci, N. Paletta, S. Defoort, E. Benard, J.E. Cooper, P. Barabinot  
*U-HARWARD: a CS2 EU Funded Project Aiming at the Design of Ultra High Aspect Ratio Wings Aircraft*  
in: AIAA Scitech 2022 Forum, AIAA, 2022, ISBN: 9781624106316, p. 1-9, AIAA 2022-0168  
[AIAA Scitech 2022 Forum, San Diego, CA, USA & Virtual Conference, 3-7 Jan. 2022]  
doi:10.2514/6.2022-0168

The final publication is available at <https://doi.org/10.2514/6.2022-0168>

Access to the published version may require subscription.

This project has received funding from the Clean Sky 2 Joint Undertaking (JU) under grant agreement No 886552. The JU receives support from the European Union's Horizon 2020 research and innovation programme and the Clean Sky 2 JU members other than the Union.



**When citing this work, cite the original published paper.**

Permanent link to this version

<http://hdl.handle.net/11311/1197640>

# U-HARWARD: a CS2 EU funded project aiming at the Design of Ultra High Aspect Ratio Wings Aircraft

S. Ricci<sup>1</sup>, N. Paletta<sup>2</sup>, S. Defoort<sup>3</sup>, E. Benard<sup>4</sup>, J.E. Cooper<sup>5</sup>, P. Barabinot<sup>6</sup>

## Abstract

The paper introduces the EU funded project CS2-U-HARWARD, started, in response to the call JTI-CS2-2019-CFP10-THT-07: Ultra-High Aspect ratio wings, aiming at the use of innovative aerodynamic and aeroelastic designs in a multi-fidelity multi-disciplinary optimal design approach to facilitate the development of Ultra-High aspect ratio wings for medium and large transport aircraft. The structure of the project, the main goals as well as the preliminary results obtained together with the due final considerations are reported.

## I. Introduction

The impacts of climate changes are clear and evident on our everyday life and they justify and explain the world effort in trying to reduce the most relevant cause of these changes universally recognized as the use of carbon-based fuels for all the energy related societal activities, including transports. The aviation world is well aware of these climate targets and since many years there are lots of activities to improve fuel-efficient and environmentally friendly aircraft designs; however, it must be admitted that the rate of improvement in performance of conventional aircraft configurations (via improved aerodynamics, composite structures and better engines) is reducing to a marginal level. As a consequence, the need to explore the benefits of novel aircraft architectures to provide a step-change in fuel efficiency is evident. This need has been identified by ICAO, FLIGHTPATH2050 and Clean Sky 2 initiatives in Europe and also NASA, with challenging goals set for reductions in CO<sub>2</sub>, NO<sub>x</sub> and noise by the year 2050 [1-3]. At EU level, the biggest part of the research funding in the field of aerospace are directed to programs having the clear object to significantly impact on the so called Destination 5, that is looking for *”Disruptive gains by 2035, with up to 30% reduction in fuel burn and CO<sub>2</sub> between the existing aircraft in service and the next generation, compared to 12-15% in previous replacement cycles (when not explicitly defined, baselines refer to the best available aircraft of the same category with entry into service prior to year 2020).”*

## II. The U-HARWARD Project

The path towards a completely carbon neutral air transport will certainly take several years, and will require intermediate steps. Although the recent announcement by Airbus of the zero emission program, with the promise of flying the first fully hydrogen-powered aircraft by 2035, it is clear that there will be a transition through more traditional architectures but with a higher level of efficiency, certainly possible even with the technologies already available at the moment. Targeting this intermediate goal, May 2020, the CS2-U-HARWARD project started, in response to the call JTI-CS2-2019-CFP10-THT-07: *Ultra-High Aspect ratio wings*, aiming at the use of innovative aerodynamic and aeroelastic designs in a multi-fidelity multi-disciplinary optimal design approach to facilitate the development of Ultra-High aspect ratio wings for medium and large transport aircraft.

Historically, the most significant improvements in jet aircraft efficiency have been related to improvements in the propulsive term associated with the development of high-bypass-ratio turbofan engines. Most recently, the extending use of high-strength composites promises to increase the weight fraction. Finally, configuration changes such as increased wingspan can lead to improving L/D. However, it must be pointed out that the integrated nature of the

---

<sup>1</sup>Professor, Politecnico di Milano, Department of Aerospace Science and Technology, 20156 Milano, Italy

<sup>2</sup>R&T manager, IBK Innovation GmbH & Co. KG, 21129 Hamburg, Germany

<sup>3</sup>The French Aerospace Lab ONERA, Location Palaiseau, France

<sup>4</sup>Associate Professor, Institut Supérieur de l'Aéronautique et de l'Espace, ISAE BP 54032 campus SUPAERO, 31055 Toulouse cedex 4, France

<sup>5</sup>Professor of Aerospace Engineering, University of Bristol, Bristol, BS8 1TR, UK. FAIAA

<sup>6</sup>Research Engineering Senior Manager, Siemens Digital Industries Software, Simulation & Test Solutions – 3D, 150 avenue de la République, 92320 Châtillon – France

aircraft design means that few substantive configuration changes can be made without incurring some multidisciplinary trade-offs. For example, increasing the wingspan can lead to an increase in wing weight.

Luckily, the same integrated nature of aircraft design could represent a great opportunity: indeed, significant improvements can come from configurations that can simultaneously exploit aerodynamic, control, and structural advances to improve efficiency. Furthermore, in most cases, the multidisciplinary approach is the only one that could guarantee a net improvement in global efficiency. It is the case of Natural Laminar Flow (NLF) that could be obtained by an aggressive combination of Maneuver (MLA) and Gust Load Alleviation (GLA) technologies that hold the potential to greatly improve both the weight and aerodynamic terms in the Breguet equation.

The consortium of U-HARWARD is composed of six partners: Politecnico di Milano, the coordinator, IBK-Innovation GmbH & Co. KG, University of Bristol, Office National d'Etudes et de Recherches Aérospatiales, Institut Supérieur de l'Aéronautique et de l'Espace and Siemens Industry Software SAS. The main idea of U-HARWARD project is to combine the modern design and manufacturing technologies to extend the actual span limit of conventional configurations, together with a deep investigation on a new, promising configuration, i.e. The Strut-Braced Wing (SBW) and finally with the feasibility studies of a new disrupting technology based on the active folding wingtip concept. To this aim, the design activities range from the conceptual up to the high fidelity level and are managed by three teams focusing on three different concepts. Team 1, composed by Politecnico di Milano and IBK, is focused on traditional cantilever wing configurations with extended aspect ratio. Team 2, composed of ONERA and ISAE, is focused on the Strut-Braced Wing configuration. Finally, Team 3 represented by the University of Bristol and Siemens, is mainly focused on folding wing tip configuration.

Figure 1 shows the project plan divided in six work packages four of them dedicated to the research activity. In particular, WP2 is focused on the conceptual and preliminary analysis of the reference and innovative configurations, WP 3 is focused on high fidelity analyses in terms of aerodynamic, aeroelastic and noise impact verification, WP4 on the different experimental campaign for concept validation and WP5 for the final assessment.

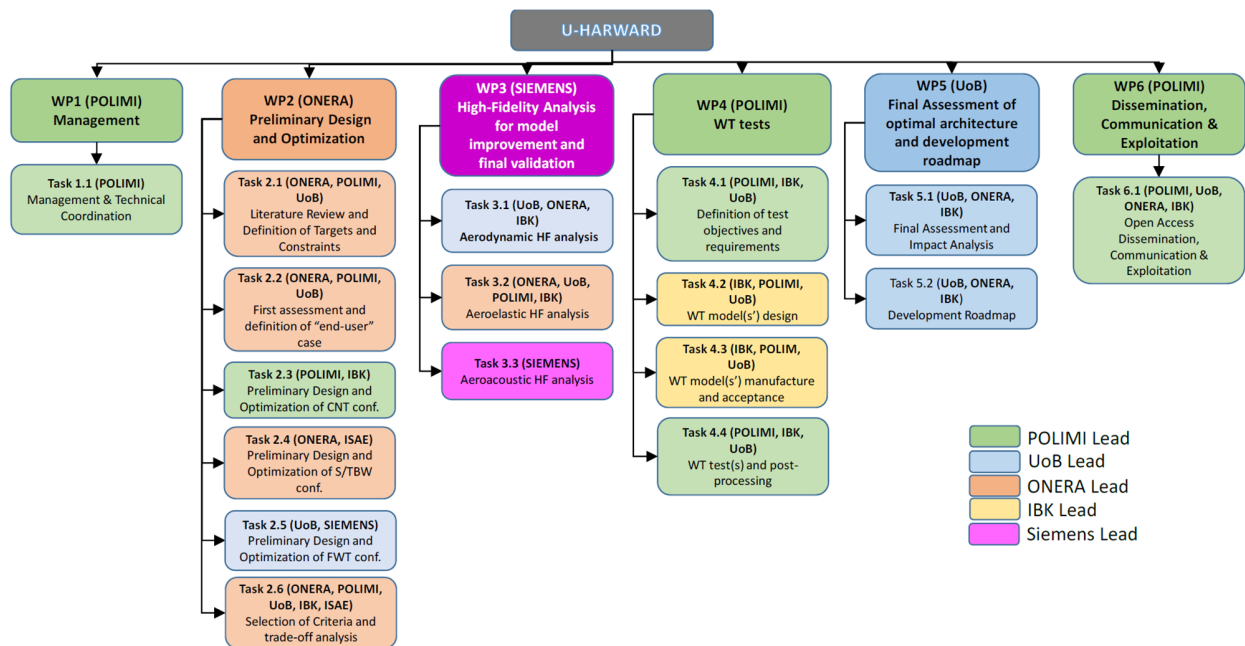
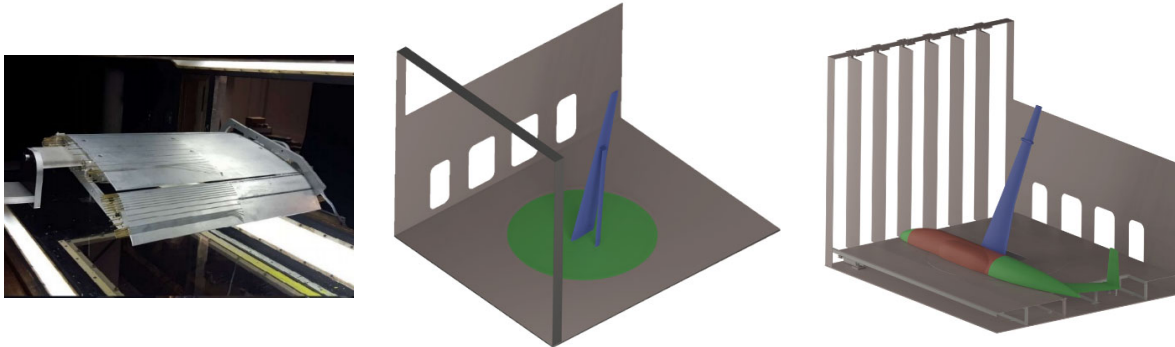

**Figure 1: The U-HARWARD Project Plan.**

The research activities of U-HARWARD project include also three main experimental campaigns, as follows;

1. An aero-acoustic wind tunnel campaign to investigate the combination of the strut and wing wakes in the generation of the airframe noise. This test campaign will be carried out at the aero-acoustic wind tunnel facility of University of Bristol with the support of SIEMENS. A portion of the wing including the strut and the TE flap will be adopted. The model will be derived by an already available model previously tested at Bristol (30P30N wing) equipped with both LE and TE flap see (Figure 2 right)
2. An aeroelastic model composed by wing+strut model will be tested at large wind tunnel of POLIMI to identify the flutter characteristics of SBW configuration and their sensitivity with respect to type and position of the connection between the strut and the wing.

- Finally, at the end of third year of the project, a large aeroelastic half model with a wing equipped with the folding wingtip mechanism will be conducted at large wind tunnel of POLIMI to investigate potential benefits and implementation issues aiming at load alleviation under discrete and continuous gust excitation. This test will take advantage of previous experience and already available setup already adopted for this kind of test during previous CS1-GLAMOUR and CS2-AIRGREEN2 EU projects.



**Figure 2: The 30P30N wing model available at University of Bristol for aeroacoustics test (left); the cantilever+strut SBW model for flutter identification (middle); the large aeroelastic half model with folding wingtip for GLA validation (right)**

### III. The Reference Aircraft

The first year activity was focused on the setup of the medium fidelity tools to be used to explore the different configurations and to perform a comparison of the capabilities of the different tools used by three teams. For the comparison purpose, a common test case has been selected, i.e. the CSR-01, that is the A320-like aircraft available in the CeRAS open data base. Then, special attention has been devoted to the selection of the Reference Aircraft to be used to compare the final performances obtained by the new configurations.

The definition of the Reference Aircraft is based on two different aspects: the mission to be completed by the aircraft, which often relies on some market segments in the aeronautics industry: regional, short-medium range, long range, and the technology level and detailed features to be implemented on this reference aircraft. Since no market segment was explicitly specified in the U-HARWARD targets, an extended analysis has been conducted to choose the most relevant mission definition, from both the benefits which can be expected for a future commercialized aircraft and the more general lessons which could be derived from the studies conducted in U-HARWARD. The decision was to investigate the extended Short Medium Range segment (SMR, meaning ~200 PAX, Design Range < 4000 NM, M~0.78) which is the one of the A321, to combine the demonstration of high benefits in this “middle of the market” segment, and the possible transposition to smaller (e.g. SMR and even regional) or bigger aircraft. Finally, once the segment is chosen, there are 3 possible choices for the reference aircraft:

- An existing, currently flying aircraft, with known geometry and features,
- A redesigned aircraft upon chosen TLAR,
- A projected aircraft with technology improvements associated with some target EIS (e.g. 2035 in most CS2 studies).

In order to avoid the biases from the design procedure (which might be different from one team to another), the choice was made to start from the reconstruction of an existing, flying aircraft, with the most recent technology level (especially engine option). Therefore, the choice was oriented towards the A321neo aircraft. This reference aircraft has been *re-designed* by each project team by stretching the fuselage of the CSR-01, obtaining a new Reference Aircraft, whose results obtained by the different teams have been compared again to ensure consistency. Starting from this new design point, it was then possible to proceed with the investigation on new high aspect ratio configurations. The data base of the Reference Aircraft will be shared with the community to be used as a new reference case for similar investigations. The results of this preliminary investigation phase allowed to define the Top Level Aircraft Requirements (TLAR) to be considered in the design of the advanced configurations, summarized in **Errore. L'origine riferimento non è stata trovata.**

#### IV. Projects Metrics

Based on the comprehensive bibliography study carried out at the beginning of the project, whose results are collected in the Deliverable D2.1, it is possible to have an overview of the expected performances of HARW concepts, to derive metrics and targets for U-HARWARD new concepts in terms of fuel burn, CO<sub>2</sub>, NO<sub>x</sub>, noise reduction. In particular, the following remarks can be drawn:

- The maximum fuel burn savings to be expected seem to lie between 20% and 30% with respect to today's references
- A possible optimum appears in terms of aspect ratio that could be between 15 and 20 (TBC since very few points are available with AR > 20)
- The efficiency improvement could be associated to a 10-25% MTOW reduction, depending on the technology options
- Strut-braced concept seems a good way to combine fuel burn savings and mass reduction, as well as high performance materials (such as Carbon Nano Tubes), but these are more aggressive design solutions and the benefits would have to be confirmed by detailed design.
- Fuel burn improvement of several cantilever and SBW concepts

The adoption of aggressive load alleviation in general, and Folding Wing Tip (FWT) concept in particular could offer:

- The possibility to perform load alleviation and increase the weight savings of the configurations
- The possibility to reach very high aspect ratios while complying with airport geometrical limits.

Concerning the noise impact:

- In U-HARWARD project, we are only considering the airframe noise, whose major source is the slat while main gear and flap contribute little. SBW configuration implies two new sources:
  - Strut self-noise, i.e. noise from the strut and strut-wing junction
  - Turbulence interaction noise due to the strut wake interacting with flaps
- Main goal: to assess these two and demonstrate whether their contribution is comparable to the slat noise or not. If not, the slat noise will remain the main source of noise so the total airframe noise won't change. If strut-related noise is strong enough, then we expect some increase in the overall airframe noise.
- Need for experiment, as this topic has no precedent in the literature.

To summarize this preliminary analysis, the following **Errore. L'origine riferimento non è stata trovata.** synthesizes the main U-HARWARD Project Targets.

**Table 1: TLARs for Reference Aircraft**

Requirement	Proposed value	Comments
Sizing Range	7400 km	XLR option with additional tanks can be investigated separately and compared to reference
Cruise Mach	0,78	Keep same commercial features; sensibility towards lower cruise speeds can be investigated to ease e.g. laminarity
PAX number	206	Arrangement in 2-class
Sizing payload	18 tons	See Payload-Range diagram
Typical range	5000 km	To be investigated: range chosen for most flown mission, optimization objective
Max Payload	23 tons	See Payload-Range diagram
Span limit	36 m	Sensitivity to be done, related to airport categories
TO & L, TTC	-	Similar to reference aircraft A321neo

**Table 2: U-HARWARD Project Targets**

Item	Nominal target w.r.t. Reference Aircraft	Options / comments
Fuel burn on nominal mission	-25%	Additional evaluations on other missions (e.g. Maximum range)
MTOW saving	-10%	To be minimized
Direct Operating Cost	-10%	Rough evaluation at project level
Aspect Ratio	15-20	Optimized as outcome of the project
Span	Same (36 m)	Relaxation of span limit to 40-45m will be studied

## V. Preliminary Investigations on Advanced Configurations

After the completion of the initial phase of the project, mainly focused on the definition of the Reference Aircraft and the identification of the Project Targets, the three teams in charge of the design of the advanced configurations started their activity that will be briefly described in the following.

### A. Cantilever Wing Configuration (CNT)

In a first exercise, a wing stretching has been applied to the original wing of the Reference Aircraft. In particular, keeping the same wing area a span increasing has been applied by keeping the engine position fixed, so to increase the aspect ratio from the original value of 10.41 up to 19. Using the NeoCASS design environment already available [4], and in particular the new Aeroelastic Optimization framework called NeOpt available at POLIMI [5], a wing structural sizing has been carried out by including the set of maneuvers requested by the CS-25 certification rules plus the flutter constraint. Different material combinations have been evaluated, starting with the classical full aluminum up to the carbon fiber with optimal fiber orientation. The optimal structural weight has been evaluated, together with its impact on the MTOW and Final Range performance by using the simplified Breguet approach. Then, by using an ad hoc module developed by IBK for the estimation of the environmental impacts, a global evaluation of the different available configurations has been carried out to obtain general maps combining Aspect Ratio, structural (and global) weight, together with range and emissions.

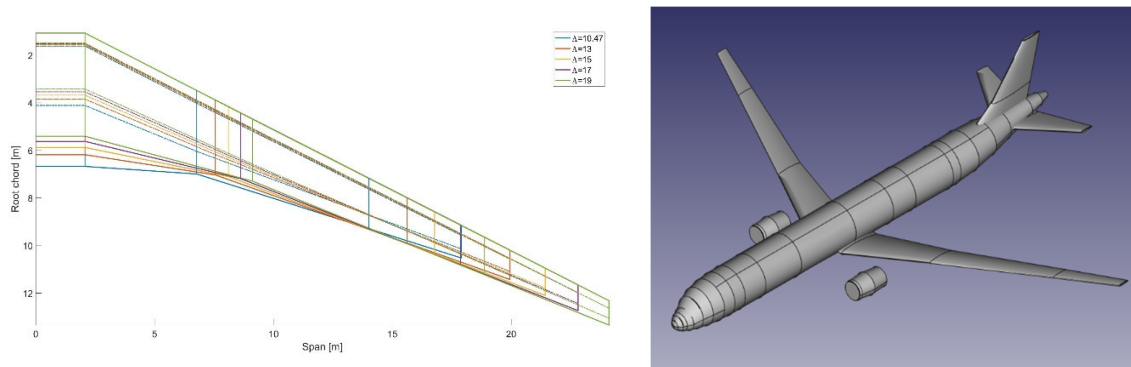
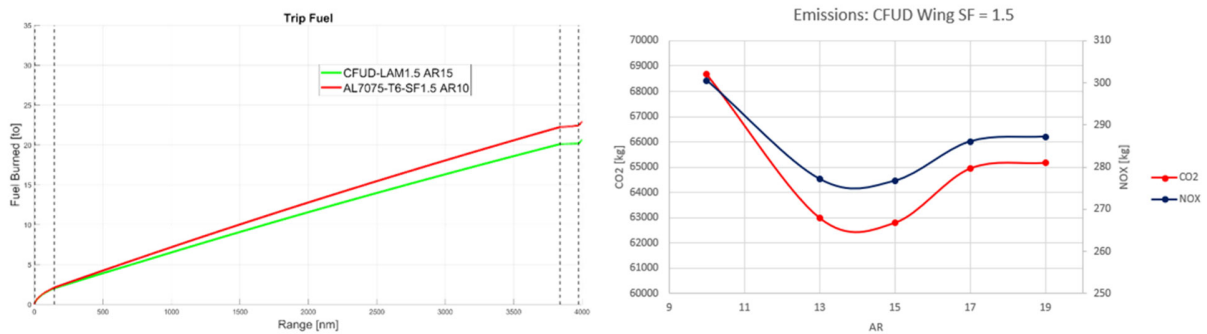

Figure 3: The wing stretching process (left) and one of the high aspect ratio configurations (right).

Table 1: results of the aeroelastic optimization for different materials adopted and increased aspect ratio, together with their impact on general performances

	AR [-]	Half wingbox Mass [kg]	Full A/C Mass [kg]	W1 [kg]	W2 [kg]	WCL [kg]	CL [-]	CDi [-]	Range [km]
AL7075-T6 SF=1.5	10.41	2193.48	87526.05	8.75E+04	7.35E+04	8.05E+04	0.57	0.011101	3784.68
	13	2337.73	89365.53	8.94E+04	7.53E+04	8.23E+04	0.59	0.009354	4244.89
	15	2601.41	91305.23	9.13E+04	7.73E+04	8.43E+04	0.60	0.008493	4515.19
	17	2916.46	93492.07	9.35E+04	7.95E+04	8.65E+04	0.62	0.007888	4726.70
	19	3975.49	97251.43	9.73E+04	8.32E+04	9.02E+04	0.64	0.007685	4801.60
CFUD red LAMI SF=1.5	10.41	1402.37	85943.81	8.59E+04	7.19E+04	7.89E+04	0.56	0.010669	3889.44
	13	1685.21	88060.50	8.81E+04	7.40E+04	8.10E+04	0.58	0.009060	4334.03
	15	2076.37	90255.13	9.03E+04	7.62E+04	8.32E+04	0.59	0.008283	4586.95
	17	2449.30	92557.75	9.26E+04	7.85E+04	8.55E+04	0.61	0.007718	4789.94
	19	2882.44	95065.32	9.51E+04	8.10E+04	8.80E+04	0.63	0.007317	4945.50



**Figure 4: Cantilever wing configuration: trip fuel comparison between aluminum and composite wing (left); emissions vs. Aspect Ratio (right).**

Trip fuel and NOX/CO<sub>2</sub> emissions have been computed for each aircraft configuration. Interestingly, the most efficient configuration does not correspond to the highest aspect ratio (AR 19 but to the AR 15 configuration). The trend of NOX and CO<sub>2</sub> emissions with respect to the different ARs for the CFUD wing is shown in Figure 4. Considering the AR 15 configuration as baseline, the trip fuel has been computed considering all the 4 combinations of polar curves and take off weights of AR 15 and AR 19 configurations. If compared to AR 15 configuration, the polar curves of the AR 19 imply only a 1% fuel saving. On the other hand, the TOW of the AR 19 implies 5% more fuel burned. The biggest impact of the higher TOW w.r.t. the improved aerodynamic efficiency is the reason why the fuel burned by the AR 19 configuration is higher by 3% than AR 15 configuration.

### B. Strut-Braced Wing Configuration (SBW)

The activity on SBW configuration carried out by ONERA and ISAE started from the experience already available from ONERA Albatros project and the design capabilities of FAST-OAD tool developed recently [6]. A lot of effort has been devoted to the implementation of an efficient global geometrical parametrization, that can be directly coupled to the aerodynamic mesh generator and solver, so to have the possibility to automatically generate different models so to analyze different configurations for sensitivity purpose. At the same time, a dedicated structural model has been included in the design tool able to capture the structural response of the SBW configuration.

Of special interest is the work done by ONERA to setup an automatic procedure to investigate the aerodynamic response of different configurations with a smooth transition from the geometrical parameter, the external surface definition, the automatic mesh and the CFD solution based on SU2 code. In order to provide higher accuracy in the evaluation of aerodynamic performances of the aircraft in cruise conditions to the Fast-OAD conceptual design framework, two distinct CFD-based aerodynamic analysis frameworks have been considered based respectively on OpenVSP and EGADS. Such frameworks handle parametric geometry representation of the aircraft with a level of detail and fidelity necessary to perform CFD-based aerodynamic analysis. This means that a CAD representation of the aircraft external aerodynamic shape is modeled. Such tools provide higher level of fidelity of the aerodynamic performance in cruise condition than the L0-level models native in the Fast-OAD framework which are based on empirical/statistical models. They provide a physics-based analysis of the flow which captures accurately its non-linear behavior (which is particularly important in the transonic cruise regime) and can therefore constitute aerodynamic models of L1 or even L2 levels of fidelity to the OAD process implemented in Fast-OAD, even though at a significantly more expensive cost in term of simulation time (typically few minutes to few tens of minutes) instead of fractions of a second for L0-level models. One important feature of these two frameworks is their ability to generate and handle (modify) a parametric representation of the aircraft geometry with a level of details and control compatible with a CFD-based analysis:

- Representation of the aircraft geometry through CAD surfaces that constitute a closed (“watertight”), manifold model, ready for application of surface tessellation methods;
- Control of those surfaces through design parameters which enable to deform the geometry with sufficient level of control to perform efficient aerodynamic design. The transonic aerodynamic design typically requires smooth deformation (maintaining smooth surface curvatures) with a control of the geometry at scales typically of the order of the centimeters or even less.

These two frameworks mostly differ in the way they model and parameterize the geometry and in the automated meshing processes that they implement allowing to generate meshes compatible with either Euler or RANS CFD simulations.

The first framework, based on OpenVSP [7] for the geometry parameterization of the aircraft, has been historically developed by ONERA under the name of CANOE **Errore. L'origine riferimento non è stata trovata.** since 2014 and enable automated Euler CFD simulations. It has been considered here as a reference, since it has been validated and applied to a wide range of use-cases over the past years.

The second framework, based on MIT Open Source library EGADS [8] and depicted in Figure 5, has been initiated more recently [10]. It offers a more accurate control of the aircraft geometry and, associated with the automated meshing capability of Pointwise using Glyph scripts, enables RANS analyses.

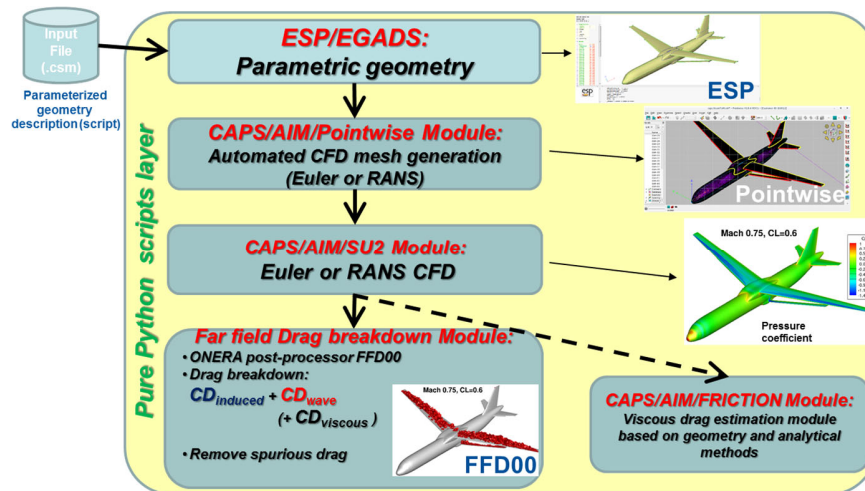

Figure 5: CFD-based aerodynamic analysis framework based on MIT tools EGADS/ESP/CAPS

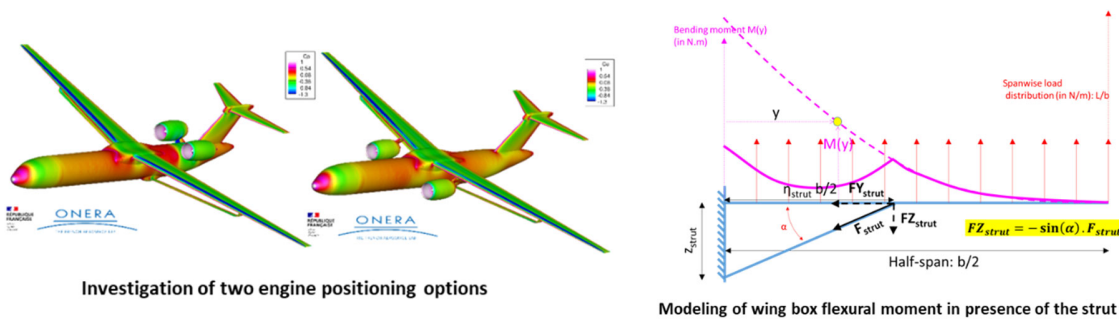

Figure 6: Example of parametric analysis by automatically changing the geometry and the aerodynamic mesh (left) and the new structural model included in the design tool to consider SBW configurations (right).

Using this framework, it is possible to make sensitivity study by changing for example the geometrical data and the engine and tail planes configuration, such as shown in Figure 6.

### C. Folding WingTip (FWT)

The activity carried out by University of Bristol on FWT configuration followed the same path started by POLIMI, by stretching the wing geometry of the reference aircraft up to an aspect ratio equal to 19 and sizing the wingbox under maneuver and gust loads conditions. Starting from this configuration, parametric analyses have been conducted by including the folding wing tip mechanism in a span position ranging from 15% to 40% of the wing span and analyzing the effect in terms of structural weight and span wise internal loads distribution [11,12].



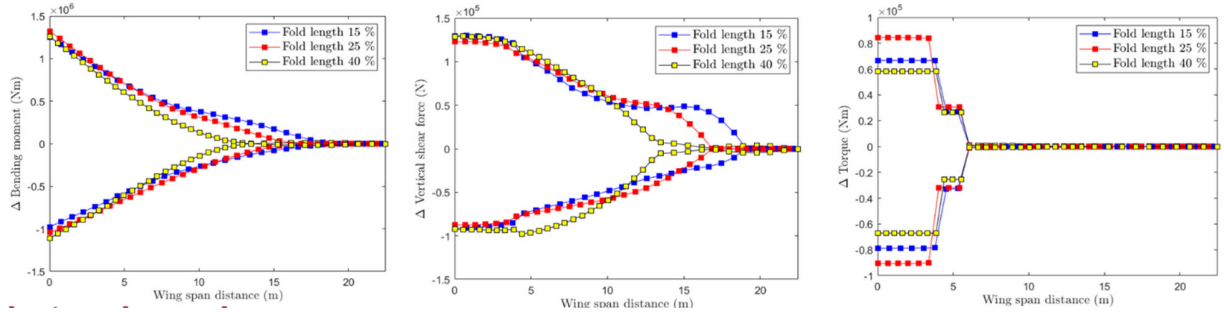

**Figure 7: Internal loads distribution for different span extension of the Folding WingTip**

For all the analyzed cases the aircraft was sized using frozen maneuver and gust conditions, by combining folding wingtip mechanism in locked (cruise and frozen maneuvers) and free configuration (for dynamic maneuvers and gusts) allowing to carry out trade off studies concerning different interesting quantities such as structural mass, emissions, flutter characteristics. For example, Figure 7 shows the impact of the presence and the extension of the folding wingtip against the incremental load due to the 1-cos discrete gust, for an assigned aspect ratio equal to 16. The significant load reduction is evident from the reported diagrams, even if there is no clear relationship between the folding wingtip size,  $\eta$ , and torque observed from the results.

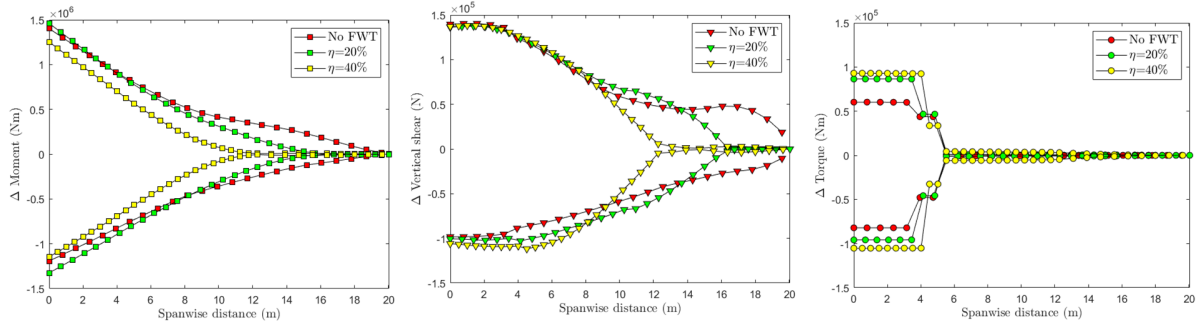

**Figure 8. Incremental gust load of AR 16 model with changing proportion of the folding wing tip.**

Further analyses have been carried out by changing the stretching strategy to increase the aspect ratio, removing the constraint on a fixed wing area. In particular, three values of wing area have been investigated, i.e. 122, 140 and 160  $m^2$ . Figure 9 shows the contour plot of the flutter speeds calculated from all sized wing-boxes. It shows that the flutter speed varies with both folding wingtip sizes and aspect ratios i.e. an increase in folding wingtip size or decrease in aspect ratio led to an increased flutter speed and vice versa. Whereas no obvious correlation between the flutter speed and wing area was observed in the study.

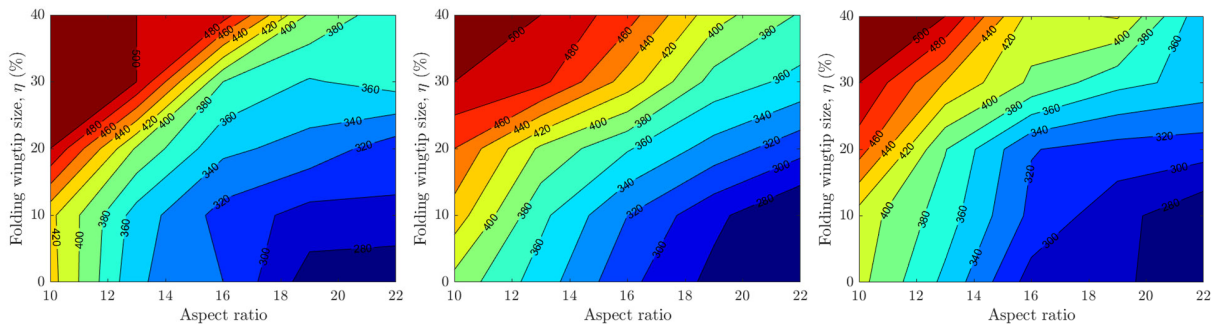

**Figure 9. Flutter speed of the sized wing-boxes with different aspect ratios, folding wingtip sizes and wing areas: (a) Wing area = 122  $m^2$ , (b) Wing area = 140  $m^2$ , (c) Wing area = 160  $m^2$ .**

## VI. Conclusions

The paper describes the main structure and goals of EU funded project CS2-U-HARWARD, started in response to the call JTI-CS2-2019-CFP10-THT-07: Ultra-High Aspect ratio wings, aiming at the use of innovative aerodynamic and aeroelastic designs in a multi-fidelity multi-disciplinary optimal design approach to facilitate the development of Ultra-High aspect ratio wings for medium and large transport aircraft. The strategy adopted by the consortium is a blend of low, medium and high fidelity approaches validated by a large wind tunnel test campaign to investigate both innovative configurations, such as the strut-braced wings, as well as specific technologies suitable for a more general application, such as enhanced aero-structural optimization techniques, aggressive active controls, innovative solutions such as the folding wingtip concept. The first phase of the project based on mainly medium fidelity tools, is almost concluded allowing for a fair comparison between the configurations investigated, i.e. highly optimized cantilever wing, strut-braced wing and folding wingtip. The next phase of the project will focus on the high fidelity analyses of most promising configurations, necessary to substantiate the potential benefits of high and ultra-high aspect ratio wings, together with the preparatory activities for the final experimental validation campaign.

## VII. Acknowledgements

This project has received funding from the Clean Sky 2 Joint Undertaking (JU) under grant agreement No 886552. The JU receives support from the European Union's Horizon 2020 research and innovation programme and the Clean Sky 2 JU members other than the Union.

A special thanks to all the members of the U-HARWARD consortium contributing to the presented results.

## VIII. Disclaimer

The content of this document reflects only the author's view. The European Commission and Clean Sky 2 Joint Undertaking (CS2JU) are not responsible for any use that may be made of the information it contains.

## IX. References

- [1] Work programme 2013 Cooperation Theme 7 Transport (including Aeronautics), European Commission C (2012) 4536 of 9 July 2012.
- [2] European Aeronautics: A Vision for 2020. Group of Personalities. 2001, ISBN 92-894-0559-7.
- [3] ACARE Strategic, Research and Innovation Agenda Vol. 1, Realising Europe's Vision for Aviation, September 2012.
- [4] L. Cavagna, S. Ricci, and L. Travaglini, "Neocass: an integrated tool for structural sizing, aeroelastic analysis and mdo at conceptual design level," *Progress in Aerospace Sciences*, vol. 47, no. 8, pp. 621–635, 2011.
- [5] L. Marchetti, F. Toffol, S. Ricci, J. Beretta and N. Paletta, "Aeroelastic Optimization of High Aspect Ratio Wings for Environmentally Friendly Aircraft", *AIAA Scitech 2022*, Sand Diego, January 3-7, 2022.
- [6] Christophe David et al., From FAST to FAST-OAD: An open source framework for rapid Overall Aircraft Design, 2021 IOP Conf. Ser.: Mater. Sci. Eng. 1024 012062.
- [7] <http://openvsp.org>, last visited on Sept 2<sup>nd</sup> 2021
- [8] R. Haimes and J. F. Dannenhoffer, "The Engineering Sketch Pad: A Solid-Modeling, Feature-Based, Web-Enabled System for Building Parametric Geometry," in *21st AIAA Computational Fluid Dynamics Conference*, 2013.
- [9] <https://github.com/yahoo/egads>
- [10] Gérald Carrier, Christophe Blondeau, Frédéric Moens, Marco Carini, Thomas Le Garrec and Daniel Mincu, Illustrations of multi-disciplinary high-fidelity analysis capabilities for aero-structural and aero-acoustic aircraft design, *AIAA Paper 2021-1316* presented at *AIAA Scitech 2021 Forum*, 11–15 & 19–21 January 2021. <https://doi.org/10.2514/6.2021-1316>
- [11] H Gu, F Healy and J.E. Cooper Sizing High Aspect Ratio Wings with Folding Wingtips. *Proc AeroBest*. Lisbon. July 2021
- [12] H Gu, F Healy, D Rezgui and J.E. Cooper Sizing of High Aspect Ratio Wings with Folding Wingtips. *AIAA Scitech 2022 Forum*. January 2022.