

# ROLLER-SCREW INERTER: A NOVEL STRUT-MOUNTED DEVICE FOR VIBRATION ISOLATION

Aykut Tamer, a.tamer@imperial.ac.uk, Imperial College London (UK)

Pierangelo Masarati, pierangelo.masarati@polimi.it, Politecnico di Milano (IT)

Michele Zilletti, michele.zilletti@leonardocompany.com, Leonardo Helicopters Division (IT)

Luigi Bottasso, luigi.bottasso@leonardocompany.com, Leonardo Helicopters Division (IT)

## Abstract

The struts that connect the main rotor and gearbox assembly to the fuselage carry the weight of airframe and payload during flight, and guarantee smooth operation to the drive system. While performing the functions they are designed for, these struts transmit the vibratory loads originating from the main rotor periodic aerodynamic loading to the airframe with essentially negligible alleviation. One technique to cure this problem is to implement strut-mounted vibration alleviation devices, to improve ride comfort by isolating the airframe from the main rotor excitation. This work presents a novel strut-mounted vibration attenuation device and demonstrates the concept through experiments and numerical analysis. The design is based on a roller screw inerter, which is mounted in parallel to the strut, sharing its attachment points. The inerter transforms the relative displacement between the two ends of the strut into a corresponding rotation of a body about an axis parallel to that of the strut. As a result, the inerter applies to its two terminals a counter-force proportional to their relative acceleration. In the ideal, frictionless case, a global isolation of the fuselage can be achieved.

## INTRODUCTION

Vibrations in rotorcraft are defined as the oscillatory response of the airframe to time dependent loads. The predominant sources of vibration are the forces and moments originating from the rotors, fuselage aerodynamics, engine and transmission. The resulting time dependent loads are transmitted to the airframe, which excites the cockpit and the cabin. In helicopters, vibrations can be the source of serious problems, from reduced performance to increased maintenance costs [1, 2]. Severe vibratory levels can even cause structural failures and loss of control. Additionally, vibrations also cause physiological and psychological reactions in the human body [3, 4], which are felt by pilots, cabin crew and passengers [5, 6, 7] of the helicopter.

In a typical helicopter, the predominant vibratory loads originate from the main rotor. Although well-balanced rotors efficiently filter vibrations at several multiples of the rotor fundamental frequency, the loads at frequencies which are integer multiples of the rotor fundamental frequency, namely its angular velocity  $\Omega$  times the number of blades  $N_b$  ( $N_b\Omega$ , or  $N_b/\text{rev}$  in non-dimensional form), are transmitted to the fuselage [8]. These  $iN_b/\text{rev}$  loads, with  $i \geq 1$ , and specifically those for  $i = 1$ , are considered as the main driver for vibration reduction, as they dominate over other sources of vibration.

Despite the improvements in technologies for reduced vibration design, such as optimization using advanced simulation tools, the implementation of vibration attenuation devices is still standard practice in the rotorcraft industry [1], and can result in substantial vibration reduction [9]. Among

many attenuation solutions (see Ref. 10 for a broad range of solutions), one preferred type is represented by active and passive vibration attenuation devices mounted in parallel to or at one terminal of the struts that support the main gearbox, as shown in Fig. 1, which provide global isolation of the latter from the main rotor excitation.

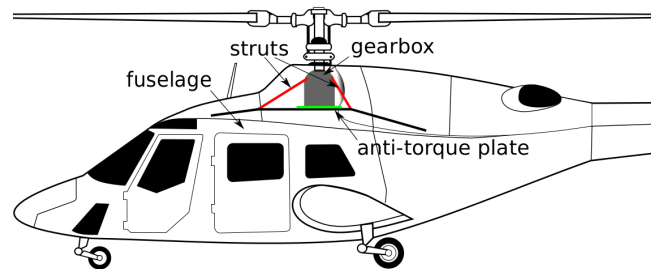

Figure 1: Main rotor gearbox struts and their typical connection points.

Passive devices are commonly used to isolate the cabin from the rotor. One of the first applications is the DAVI (Dynamic Anti-resonant Vibration Isolator), which can be mounted in parallel to the gearbox suspension [11, 12]. A similar device is the ARIS (Anti-Resonance Isolation System), with mechanical and hydraulic versions [13]. An alternative device, whose tuning mass is located in series with the gearbox suspension, is the SARIB (*Suspension Anti-Résonante Intégrée à Barres*, or anti-resonance suspension integrated with the struts) [14]. A different technique consists in accelerating a low viscosity fluid between two chambers and letting the pressure differential caused by the

relative motion counteract the vibratory load [15, 16, 17]. The LIVE, or Fluidlastic<sup>1</sup>, is an example of this concept [18].

A new type of mechanical device used in vibration attenuation is the inerter [19]. An inerter generates an internal force in response to a relative acceleration of its terminals, therefore it may be considered analogous to a capacitor in an electric circuit. Since the late 2000s, some types of inerters have been designed based on rack-pinion and screw mechanisms. Both of these types rely on amplification of linear motion by converting it into rotational motion by means of gears of threads. As demonstrated in Fig. 2, the resulting forcing response is proportional to an inertial constant:

$$(1) \quad \Delta f = b\Delta\ddot{x}$$

where the inertance ( $b$ , an equivalent mass) is based on the type of inerter.

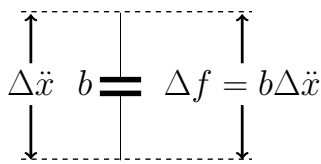

Figure 2: The inerter produces an internal force proportional to the relative acceleration.

To exploit the inerter concept in helicopter vibration alleviation, a roller-screw type inerter is designed, aimed to be mounted in parallel to the strut. Roller screws are suitable for this purpose for several reasons:

- High load capacity: The vibratory loads transferred through the struts are high enough to cause significant vibrations in the cabin.
- Low friction: Among screw mechanisms, a roller screw is a low-friction type, which increases vibration attenuation performance.
- Low screw lead: Screw lead directly affects the amplification of rotation speed, which increases the amplitude of the force generated by the inerter. Roller screws can reach much lower screw leads compared to ball screws.
- Symmetric and compact structure: The volume is almost always limited near the gearbox area. Therefore, a successful design needs to be compact and possibly enclose the strut to save space, rather than being mounted to its side.

This work presents a novel device for helicopter vibration isolation at  $N_b/\text{rev}$  rotor passage frequency and demonstrates its benefits through experiments and numerical analysis. The next Section explains the concept and how a compact roller-screw inerter is designed to be mounted in parallel to a gearbox strut. The design was followed by experimental activity aimed at demonstrating the concept and

<sup>1</sup>Fluidlastic™ is a trademark of Lord Corporation, Inc.

identifying the friction characteristics of the device at typical  $N_b/\text{rev}$  frequencies. Subsequently, using the identified friction of the device, its application to a quarter helicopter model (a simplified and idealized model consisting of a single strut connecting a quarter of the airframe and gearbox equivalent masses) shows the potential benefits of an ideal and a realistic implementation of the inerter. The last Section reports the key findings of this study and discusses the additional work required to implement the concept on real helicopters.

## CONCEPT & DESIGN

Based on the mentioned considerations, a strut mounted vibration attenuation device was designed, based on a roller screw inerter, which was recently patented [20].

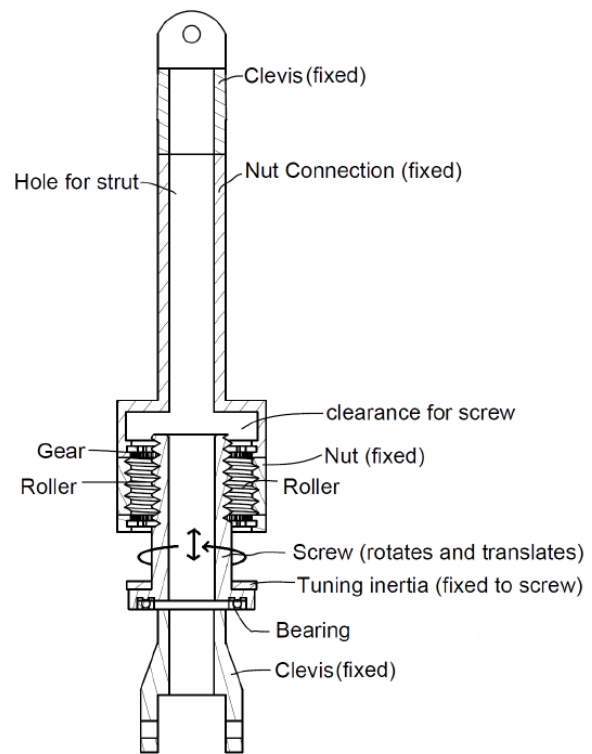

Figure 3: Strut mounted roller screw inerter.

Figure 3 presents the roller screw inerter concept, which is explained as follows:

- the screw end is designed such that a bearing can be mounted at the end;
- the bearing is located between the screw end and a convenient support, which allows relative rotation of the screw about its longitudinal axis;
- on the other side, the nut has an extension that is clamped to the other support, therefore holds the nut fixed;

- the inerter supports enclose the strut through a hole;
- the strut and the inerter supports are mounted to the gearbox and airframe using common pins;
- when a relative motion is imposed at the two ends, the stationary nut guides the rollers;
- the rollers, which are synchronized using gears, rotate the screw and the attached flywheel, therefore converting the motion from linear to rotational;
- an inertia disc is fixed on the screw shaft, which is tuned for a specific frequency to generate a counter-acting force proportional to the square of the frequency.

Since the inertance ( $b$ ) is the critical parameter for tuning, it is worth mentioning how it is obtained for this particular design. In case of the roller-screw inerter, the value of  $b$  depends on the total inertia of the rotating mass ( $I = I_{disc} + I_{screw}$ ), which evaluates to:

$$(2) \quad b = \frac{I}{P^2}$$

where  $P$  is the pitch of the screw, namely the axial displacement following a  $2\pi$  rad rotation.

## EXPERIMENTAL IDENTIFICATION

### Specimen

The testing specimen was purchased from Rollvis [21] with the bespoke features, fully assembled by the manufacturer, as presented in Fig. 4. The test specimen is composed of:

- a screw that rotates with respect to the nut;
- a circular screw end that is pinned to the screw and provides a set of holes for mounting tuning masses
- a flanged nut which includes rollers inside and holes for assembly;
- a bearing attached to the screw shaft, to apply axial force to the screw without transferring any torque.

To change the equivalent mass, a series of large 10 mm thick discs are used. Finer tuning is possible by further varying the amount of rotating mass.

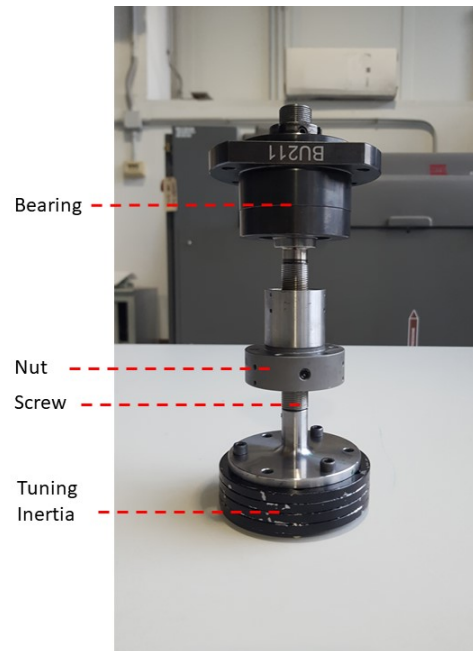

Figure 4: Rollvis roller screw converted to inerter using tuning discs.

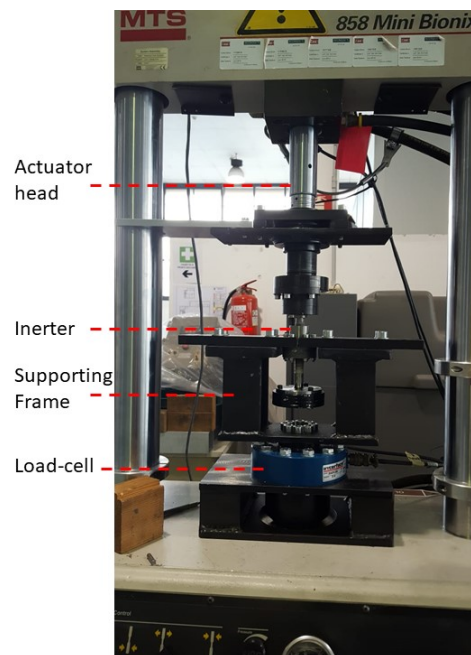

Figure 5: Test set-up

### Set-Up

The test set-up involves a MTS 858 Bionix actuator, the inerter, a load-cell and an interface to connect the inerter to the actuator and the load-cell, as shown in Fig. 5. Everything was assembled using a custom rigid support frame, designed to provide completely separate load paths for axial force and torque, thus allowing the independent measurement of the axial force and residual torque resulting from

any friction in the bearings. The dynamic characterization of the roller screw was performed by measuring the stroke-load relation. Due to load-cell and actuator limits, reliable data was obtained up to slightly above 20 Hz. Considering typical blade passing frequencies of medium weight helicopters [22], 20 Hz can be considered a representative value.

## Measurements

First, the friction characteristics were identified from a low inertia configuration, to minimize the contribution of inertial loads. For this purpose, the tuning discs and the support disc were removed. The friction characteristics as a function of the excitation frequency were identified for two motion amplitudes, 0.1 mm and 0.2 mm. The results show that friction does not significantly depend on the amplitude of the excitation, but it appears to linearly depend on frequency. The identification of the friction characteristics is necessary to compare the measurements with the analytical model and obtain a realistic quarter helicopter model to demonstrate the idea. Additionally, friction is crucial to address existing nonlinearities, which have significant impact on the dynamic response of the coupled device-rotorcraft system [23, 24].

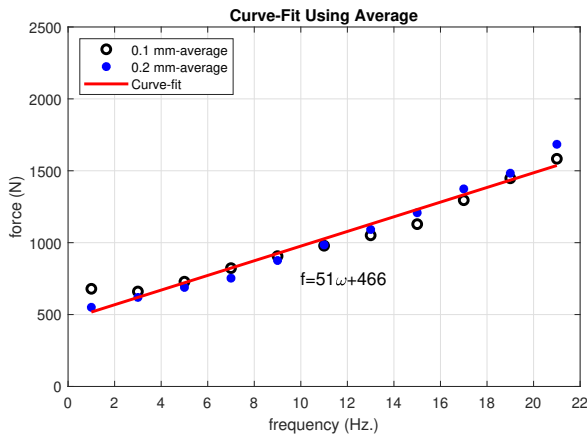

Figure 6: Friction identification obtained using very low rotating inertia.

After the friction was identified, the inerter was tested with tuning masses for two configurations using two and four discs. The amplitude was kept at 0.1 mm, owing to load cell and actuator limits. The measurements were compared with analytical results which included inertia and friction (Fig. 6). Since the screw shaft and circular extension also contribute to the inertia, they were also included in the estimated inertance, which leads to the force relation:

$$(3) \quad f = (b_{discs} + b_{screw})\dot{x} + f_f(\omega, \dot{x}).$$

The results are presented in Figs. 7 and 8. They show good correlation with the analytical model, which indicates

that the roller-screw inerter concept is worth demonstrating as a strut-mounted vibration absorber.

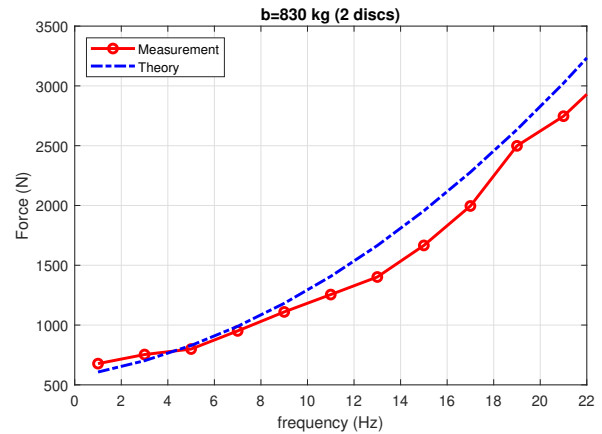

Figure 7: Force Measurement of 2 disc configuration and comparison with theory (linear inerter+friction)

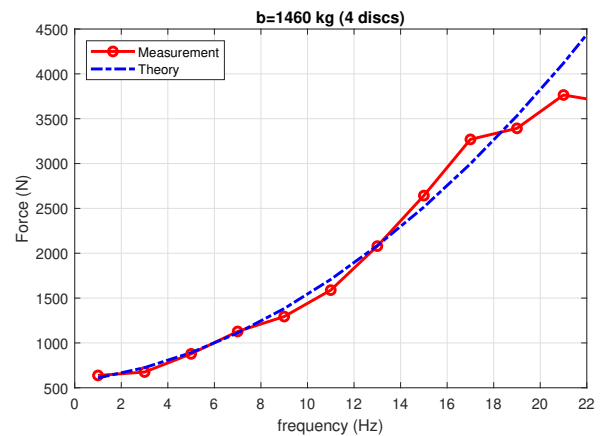

Figure 8: Force Measurement of 4 disc configuration and comparison with theory (linear inerter+friction)

## NUMERICAL ANALYSIS

Consider the simplified quarter helicopter model sketched in Figure 9.

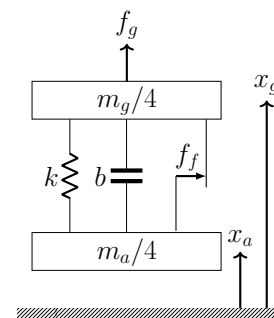

Figure 9: Quarter H/C model

The airframe and the gearbox are represented by lumped masses  $m_a$  and  $m_g$ , with  $m_a \gg m_g$ , which are connected by a spring of stiffness  $k$  representing a strut. The friction identified in Fig. 6 was added as a friction element with amplitude  $f_f$ , which is the nonlinear element of the system. The rotor excitation is idealized by a force at  $N_b/\text{rev}$  blade passing frequency acting on the gearbox,  $f_g$ . The equations of motion are:

$$(4) \quad \begin{bmatrix} m_g + b & -b \\ -b & m_a + b \end{bmatrix} \begin{bmatrix} \ddot{x}_g \\ \ddot{x}_a \end{bmatrix} + \begin{bmatrix} k & -k \\ -k & k \end{bmatrix} \begin{bmatrix} x_g \\ x_a \end{bmatrix} = \begin{bmatrix} f_g \\ 0 \end{bmatrix} + \begin{bmatrix} f_f \\ -f_f \end{bmatrix}$$

where  $f_f = \bar{f}(\omega)\text{sign}(\dot{x}_g - \dot{x}_a)$  represents the frequency-dependent friction contribution, whereas  $x_a$  and  $x_g$  are the airframe and gearbox displacements, respectively. Data typical of medium weight helicopters [25] are used in the analysis. They are reported in Table 1.

Table 1: Quarter helicopter model data.

Symbol	Definition	Value
$m_g$	gearbox mass (kg)	1000
$m_a$	airframe mass (kg)	6000
$N_b\Omega$	main rotor excitation freq. (Hz)	20
$k$	strut stiffness ( $\text{N m}^{-1}$ )	$100 \times 10^6$

For the ideal attenuated case,  $b = k/\omega^2$  is the tuning value of the absorber. When tuned at the rotor excitation frequency  $N_b/\text{rev}$ , the amplitude of the airframe vibratory level vanishes for an inerter with zero friction. However, the friction reduces the effectiveness of the absorber and in reality some vibratory response is transferred. Since energy loss through friction is a nonlinear phenomenon, the overall response depends on that of the vibration attenuation system, which is a function of forcing. For this reason, the model was analyzed for different forcing levels.

The numerical results of the baseline (without inerter,  $b = 0$ ) and the attenuated (with inerter,  $b = k/\omega^2$ ) configurations can be calculated by solving a linear equation, which can also be scaled with the force amplitude. The system becomes nonlinear when the friction is introduced, therefore requiring time integration or harmonic balance to obtain a steady state solution. In this work, time integration was used to obtain the nonlinear result at different  $N_b/\text{rev}$  forcing levels.

Fig. 10 presents the time response for three periods of excitation at five equally spaced forcing amplitudes, ranging from 2000 N to 10000 N. The plots include: a) the baseline configuration without inerter, b) the linear model with a frictionless inerter, and c) the nonlinear model including the inerter with experimentally identified friction. The results show that the benefits of the inerter increase as the forcing amplitude increases. This is due to the friction model identified from the tests, which showed that the friction is not a function of the amplitude (Fig. 6). This aspect could be better observed by extracting the ratio of the fuselage response amplitude to that of baseline, which is reported in Table 2.

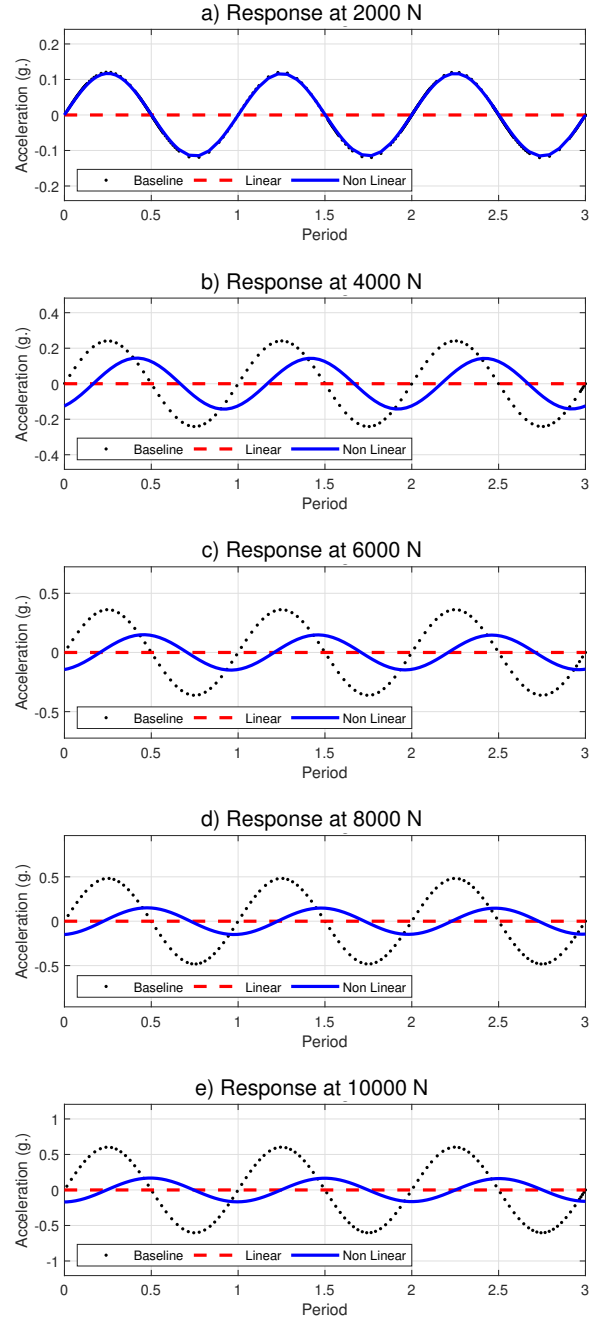

Figure 10: Fuselage response of the quarter helicopter model to harmonic excitation on gearbox mass at different forcing amplitudes.

Table 2:  $N_b/\text{rev}$  acceleration of the attenuated configuration ( $b = k/\omega^2$ ) relative to the gearbox acceleration of the baseline ( $b = 0$ )

Force Level (N)	Baseline ( $b = 0$ )	Attenuated ( $b = k/\omega^2$ )
2000	1.00	0.97
4000	1.00	0.73
6000	1.00	0.56
8000	1.00	0.43
10000	1.00	0.36

The table clearly shows that the inerter is more effective at increasing vibratory force amplitude, while at lower forcing levels the added complexity is not justified.

## CONCLUSIONS

This work presented a novel strut-mounted device to isolate the fuselage of a helicopter from the excitation originating at the main rotor. The concept was presented and explained. To demonstrate it, an off-the-shelf roller screw was turned into an inerter with a bearing and flywheel that could hold a variable number of tuning discs. The specimen was tested to show that this kind of device can produce the expected behaviour and identify the amount of friction that occurs in operation. Using the identified friction model, the potential advantages of the inerter were demonstrated over a quarter helicopter model. The numerical and experimental results showed that:

- The inerter behaves as expected and creates a force proportional to its inertance plus the friction in the system.
- The friction seems to be independent of the motion amplitude. For this reason, the effectiveness of the inerter reduces at small forcing amplitude. At greater amplitudes, the static friction force can be overcome and vibrations could be attenuated more efficiently.
- At the measured friction levels, the linear inerter assumption would lead to erroneous results, with an underestimation of the fuselage vibration response.
- The device is not affected by the need to accommodate different values of static load/stroke, as the inerter does not react to a constant or quasi-static stroke. This is a clear advantage of this type of solution.

To better understand the feasibility of using a roller screw inerter in real world conditions, the following aspects should be addressed in future research:

- Friction: While at high force levels the device showed benefits, the friction limited its effectiveness at low forcing amplitude. However, there is reason to be optimistic with regard to friction, since the roller-screw and the bearing used in this work were not specifically designed for vibration attenuation purposes. Therefore, research on low friction roller screw inerters and dedicated designs could lead to more effective vibration attenuation devices.
- Durability: This work did not focus on the durability of the inerter, which remains an open issue. Since determining the airworthiness of the concept requires a better understanding of the durability of its components, this aspect should be addressed in future research.

- Stroke and Frequency Limits: Current experiments provided enough knowledge on the proof of concept, but the test machine and controller limits did not allow to test higher amplitudes and frequencies. High load amplification of the roller screw requires a more powerful test equipment system.
- Absorption Demonstration: This study did not include a strut in parallel to the inerter during the experiments. A dedicated set-up, using a real helicopter strut attached in parallel to the inerter device, is needed to demonstrate the feasibility of the arrangement.

## Copyright Statement

The authors confirm that they, and/or their company or organization, hold copyright on all of the original material included in this paper. The authors also confirm that they have obtained permission, from the copyright holder of any third party material included in this paper, to publish it as part of their paper. The authors confirm that they give permission, or have obtained permission from the copyright holder of this paper, for the publication and distribution of this paper as part of the ERF proceedings or as individual offprints from the proceedings and for inclusion in a freely accessible web-based repository.

## ACKNOWLEDGEMENTS

This work was funded by Leonardo Helicopter Division.

## References

- [1] Wayne Johnson. *Rotorcraft Aeromechanics*. Cambridge University Press, New York, 2013.
- [2] A.C. Veca. Vibration effects on helicopter reliability and maintainability. TM 73-11, NASA, 1973.
- [3] Jessica K. Ljungberg and Gregory Neely. Stress, subjective experience and cognitive performance during exposure to noise and vibration. *Journal of Environmental Psychology*, 27(1):44 – 54, 2007.
- [4] Aykut Tamer, Vincenzo Muscarello, Giuseppe Quaranta, and Pierangelo Masarati. Cabin layout optimization for vibration hazard reduction in helicopter emergency medical service. *Aerospace*, 7(5), 2020.
- [5] Giuseppe Quaranta, Aykut Tamer, Vincenzo Muscarello, Pierangelo Masarati, Massimo Gennaretti, Jacopo Serafini, and Marco Molica Colella. Evaluation of rotorcraft aeroelastic stability using robust analysis. In *38th European Rotorcraft Forum*, Amsterdam, NL, 2012.
- [6] Aykut Tamer, Andrea Zanoni, Vincenzo Muscarello, Alessandro Cocco, Giuseppe Quaranta, and Pierangelo Masarati. Biodynamic modeling techniques for rotorcraft comfort evaluation. *Aerotecnica Missili & Spazio*, June 2019.

- [7] Aykut Tamer, Andrea Zaroni, Alessandro Cocco, and Pierangelo Masarati. A numerical study of vibration-induced instrument reading capability degradation in helicopter pilots. *CEAS Aeronaut. J.*, 12(2):427–440, April 2014. doi:10.1007/s13272-021-00516-8.
- [8] Richard L. Bielawa. *Rotary Wing Structural Dynamics and Aeroelasticity*. AIAA, Washington, DC, 2nd edition, 2005.
- [9] Aykut Tamer, Vincenzo Muscarello, Pierangelo Masarati, and Giuseppe Quaranta. Evaluation of vibration reduction devices for helicopter ride quality improvement. *Aerospace Science and Technology*, 95:105456, 2019.
- [10] Tomasz Kryszynski and François Malburet. *Mechanical Vibrations*. ISTE Ltd, 2007.
- [11] R.A. Desjardins and W.E. Hooper. Rotor Isolation of the hingeless rotor BO-105 and YUH-61 helicopters. In *2nd European Rotorcraft and Powered Lift Aircraft Forum*, 1976.
- [12] R.A. Desjardins and W.E. Hooper. Antiresonance rotor isolation for vibration reduction. In *American Helicopter Society 34th Annual Forum*, Washington DC, May 1978.
- [13] D. Braun. Development of antiresonance force isolators for helicopter vibration reduction. In *6th European Rotorcraft Forum*, Bristol, UK, September 1980.
- [14] P. Hege and G. Genoux. The SARIB vibration absorber. In *9th European Rotorcraft and Powered Lift Aircraft Forum*, September 1983.
- [15] D.R. Halmes. LIVE liquid inertia vibration eliminator. In *American Helicopter Society 36th Annual Forum*, Washington DC, May 1980.
- [16] D.R. Halwes. Total main rotor isolation system. In *American Helicopter Society Northeast Region Specialist Meeting on Helicopter Vibration*, Hartford, CT, November 1981.
- [17] D.R. Halwes. Total main rotor isolation system analysis. CR NAS1-16211, NASA, 1981.
- [18] Dennis P. McGuire. Active vibration control using fluidlastic pylon struts. In *American Helicopter Society 62nd Annual Forum*, Phoenix, Arizona (USA), May 9–11 2006.
- [19] M. Z. Q. Chen, C. Papageorgiou, F. Scheibe, F. Wang, and M. C. Smith. The missing mechanical circuit element. *IEEE Circuits and Systems Magazine*, 9(1):10–26, First 2009.
- [20] Luigi Bottasso, Attilio Colombo, Pierangelo Masarati, Aykut Tamer, and Giuseppe Quaranta. Helicopter kit, EP3599164B1, US 2020/0391857 A1.
- [21] ROLLVIS SA. <http://www.rollvis.com> (last accessed June 2021).
- [22] Aykut Tamer, Andrea Zaroni, Alessandro Cocco, and Pierangelo Masarati. A generalized index for the assessment of helicopter pilot vibration exposure. *Vibration*, 4(1):133–150, 2021.
- [23] Aykut Tamer and Pierangelo Masarati. Helicopter rotor aeroelastic stability evaluation using Lyapunov exponents. In *40th European Rotorcraft Forum*, Southampton, UK, September 2–5 2014.
- [24] A. Tamer and P. Masarati. Stability of nonlinear, time-dependent rotorcraft systems using Lyapunov characteristic exponents. *Journal of the American Helicopter Society*, 61(2):14–23, 2016. .
- [25] Aykut Tamer, Andrea Zaroni, Matteo Daniele, and Pierangelo Masarati. Multibody analysis of the influence of strut-mounted vibration alleviation devices on rotor aeromechanics. In *8th Asian/Australian Rotorcraft Forum*, Ankara, TR, 2019.